

X4-Class Power MOSFET™

IXTT220N20X4HV

$V_{DSS} = 200V$
 $I_{D25} = 220A$
 $R_{DS(on)} \leq 5.5m\Omega$

N-Channel Enhancement Mode
Avalanche Rated

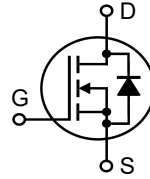

TO-268HV
(IXTT..HV)

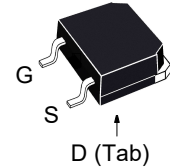

G = Gate D = Drain
 S = Source Tab = Drain

Symbol	Test Conditions	Maximum Ratings	
V_{DSS}	$T_J = 25^\circ C$ to $175^\circ C$	200	V
V_{DGR}	$T_J = 25^\circ C$ to $175^\circ C$, $R_{GS} = 1M\Omega$	200	V
V_{GSS}	Continuous	± 20	V
V_{GSM}	Transient	± 30	V
I_{D25}	$T_C = 25^\circ C$	220	A
$I_{L(RMS)}$	External Lead Current Limit	160	A
I_{DM}	$T_C = 25^\circ C$, Pulse Width Limited by T_{JM}	400	A
I_A	$T_C = 25^\circ C$	110	A
E_{AS}	$T_C = 25^\circ C$	900	mJ
dv/dt	$I_S \leq I_{DM}$, $V_{DD} \leq V_{DSS}$, $T_J \leq 150^\circ C$	50	V/ns
P_D	$T_C = 25^\circ C$	800	W
T_J		-55 ... +175	$^\circ C$
T_{JM}		175	$^\circ C$
T_{stg}		-55 ... +175	$^\circ C$
T_{SOLD}	Plastic Body for 10s	260	$^\circ C$
Weight		4	g

Features

- International Standard Package
- Low $R_{DS(ON)}$ and Q_G
- Avalanche Rated
- Low Package Inductance

Advantages

- High Power Density
- Easy to Mount
- Space Savings

Applications

- Switch-Mode and Resonant-Mode Power Supplies
- DC-DC Converters
- PFC Circuits
- AC and DC Motor Drives
- Robotics and Servo Controls

Symbol	Test Conditions ($T_J = 25^\circ C$, Unless Otherwise Specified)	Characteristic Values		
		Min.	Typ.	Max.
BV_{DSS}	$V_{GS} = 0V$, $I_D = 250\mu A$	200		V
$V_{GS(th)}$	$V_{DS} = V_{GS}$, $I_D = 250\mu A$	2.5		4.5 V
I_{GSS}	$V_{GS} = \pm 20V$, $V_{DS} = 0V$			± 100 nA
I_{DSS}	$V_{DS} = V_{DSS}$, $V_{GS} = 0V$ $T_J = 150^\circ C$			10 μA 1.5 mA
$R_{DS(on)}$	$V_{GS} = 10V$, $I_D = 0.5 \cdot I_{D25}$, Note 1		4.1	5.5 m Ω

Symbol	Test Conditions ($T_J = 25^\circ\text{C}$, Unless Otherwise Specified)	Characteristic Values		
		Min.	Typ.	Max
g_{fs}	$V_{DS} = 10\text{V}, I_D = 60\text{A}$, Note 1	90	150	S
R_{Gi}	Gate Input Resistance		1.6	Ω
C_{iss}	} $V_{GS} = 0\text{V}, V_{DS} = 25\text{V}, f = 1\text{MHz}$		12.3	nF
C_{oss}			1650	pF
C_{rss}			5.4	pF
Effective Output Capacitance				
$C_{o(er)}$	Energy related } $V_{GS} = 0\text{V}$		900	pF
$C_{o(tr)}$	Time related } $V_{DS} = 0.8 \cdot V_{DSS}$		3400	pF
Resistive Switching Times				
$t_{d(on)}$	} $V_{GS} = 10\text{V}, V_{DS} = 0.5 \cdot V_{DSS}, I_D = 0.5 \cdot I_{D25}$ $R_G = 2\Omega$ (External)		30	ns
t_r			15	ns
$t_{d(off)}$			87	ns
t_f			6	ns
$Q_{g(on)}$	} $V_{GS} = 10\text{V}, V_{DS} = 0.5 \cdot V_{DSS}, I_D = 0.5 \cdot I_{D25}$		157	nC
Q_{gs}			50	nC
Q_{gd}			46	nC
R_{thJC}				0.19 $^\circ\text{C/W}$

Source-Drain Diode

Symbol	Test Conditions ($T_J = 25^\circ\text{C}$, Unless Otherwise Specified)	Characteristic Values		
		Min.	Typ.	Max
I_s	$V_{GS} = 0\text{V}$			220 A
I_{SM}	Repetitive, pulse Width Limited by T_{JM}			880 A
V_{SD}	$I_F = 100\text{A}, V_{GS} = 0\text{V}$, Note 1			1.4 V
t_{rr}	} $I_F = 110\text{A}, -di/dt = 100\text{A}/\mu\text{s}$ $V_R = 100\text{V}$		140	ns
Q_{RM}			770	nC
I_{RM}			11	A

Note 1. Pulse test, $t \leq 300\mu\text{s}$, duty cycle, $d \leq 2\%$.

Littelfuse reserves the right to change limits, test conditions and dimensions.

IXYS MOSFETs and IGBTs are covered by one or more of the following U.S. patents:

4,835,592	4,931,844	5,049,961	5,237,481	6,162,665	6,404,065B1	6,683,344	6,727,585	7,005,734B2	7,157,338B2
4,860,072	5,017,508	5,063,307	5,381,025	6,259,123B1	6,534,343	6,710,405B2	6,759,692	7,063,975B2	
4,881,106	5,034,796	5,187,117	5,486,715	6,306,728B1	6,583,505	6,710,463	6,771,478B2	7,071,537	

Fig. 1. Output Characteristics @ $T_J = 25^\circ\text{C}$

Fig. 2. Extended Output Characteristics @ $T_J = 25^\circ\text{C}$

Fig. 3. Output Characteristics @ $T_J = 150^\circ\text{C}$

Fig. 4. $R_{DS(on)}$ Normalized to $I_D = 110\text{A}$ Value vs. Junction Temperature

Fig. 5. $R_{DS(on)}$ Normalized to $I_D = 110\text{A}$ Value vs. Drain Current

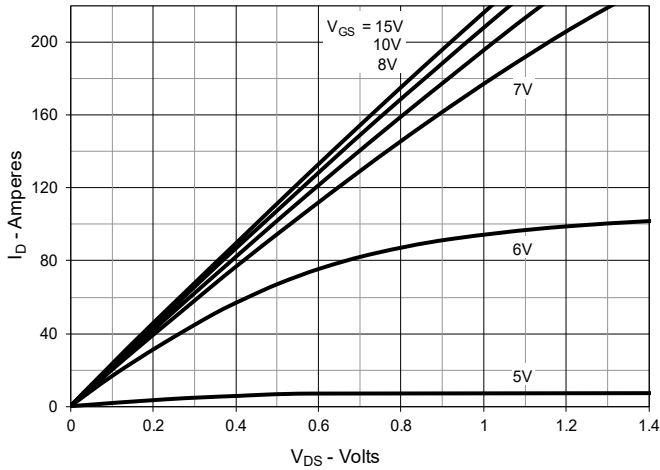
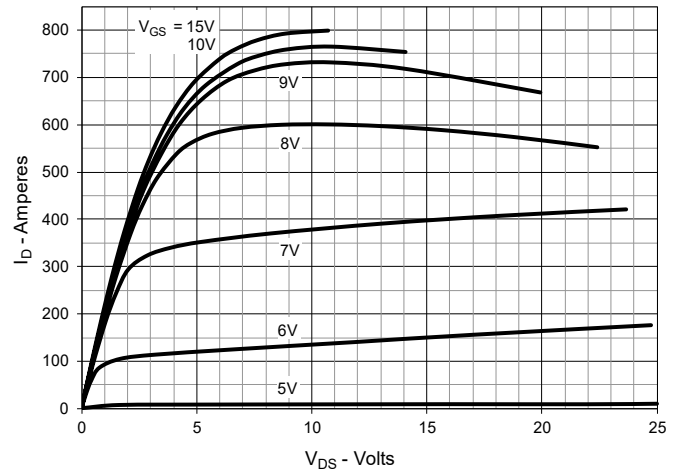
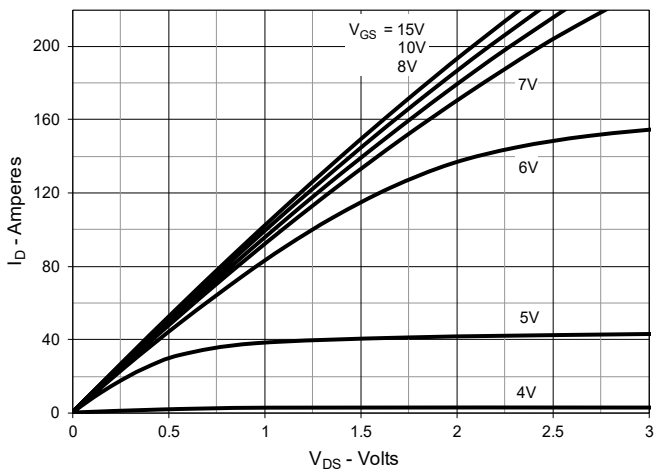
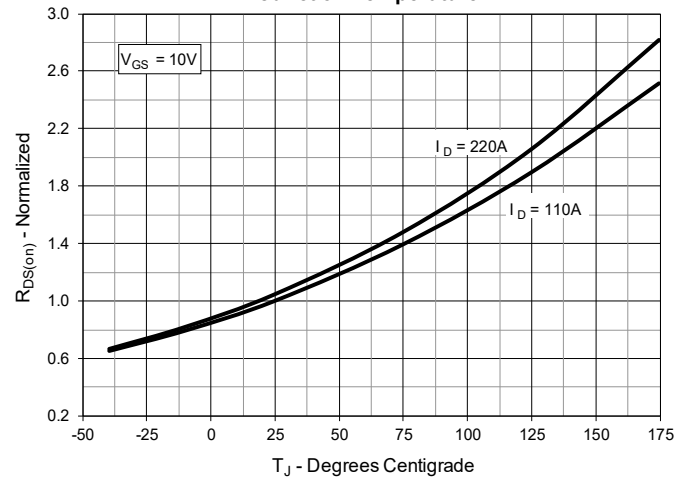
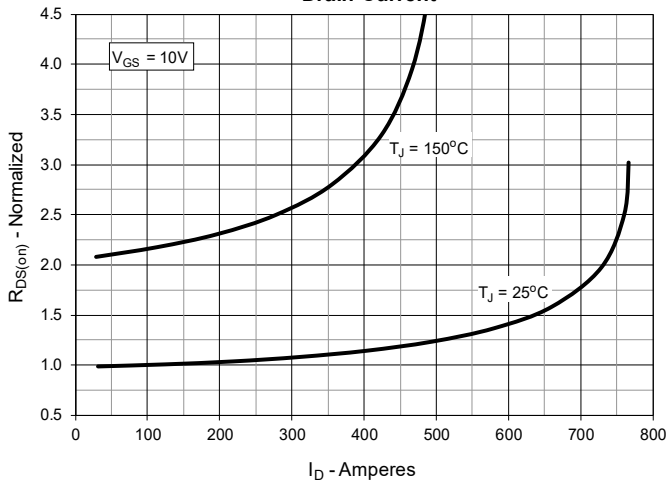
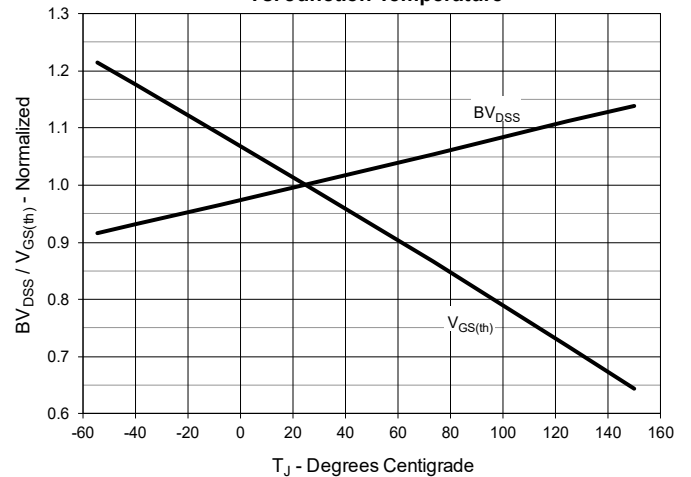
Fig. 6. Normalized Breakdown & Threshold Voltages vs. Junction Temperature

Fig. 7. Maximum Drain Current vs. Case Temperature

Fig. 8. Input Admittance

Fig. 9. Transconductance

Fig. 10. Forward Voltage Drop of Intrinsic Diode

Fig. 11. Gate Charge

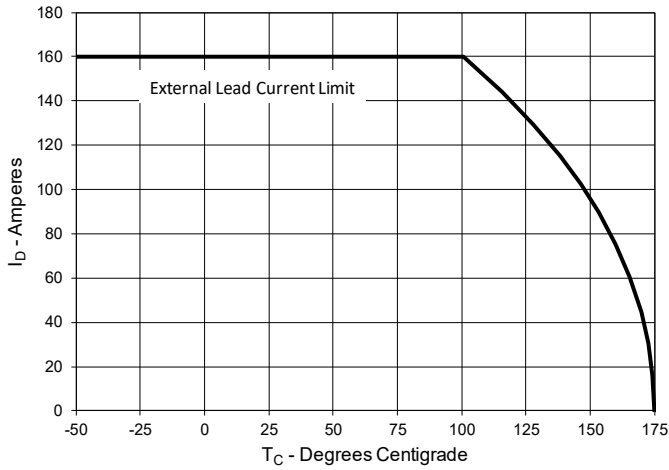
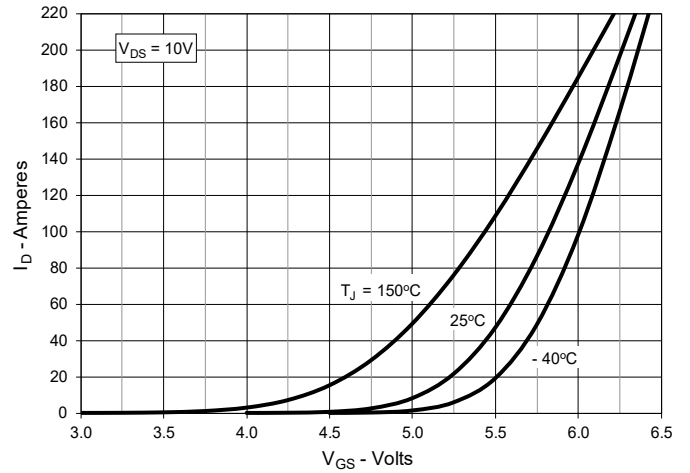
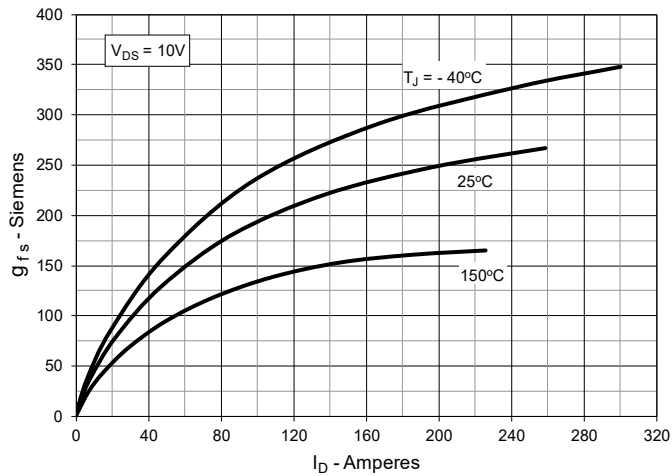
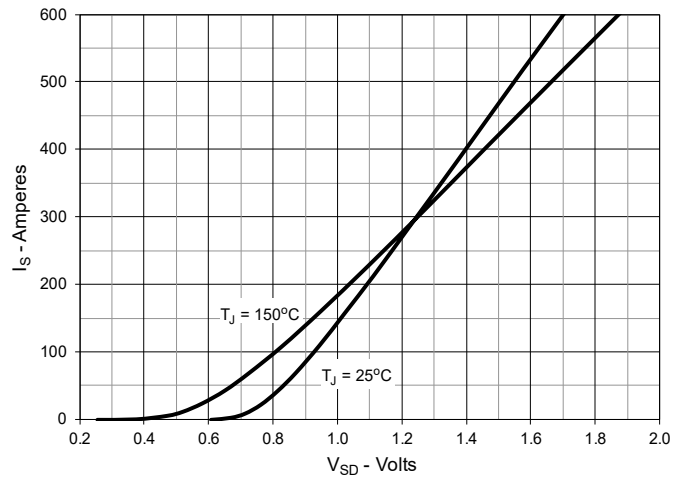
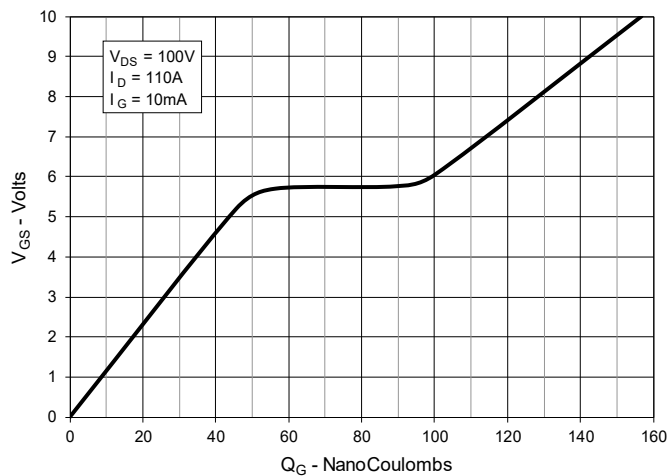
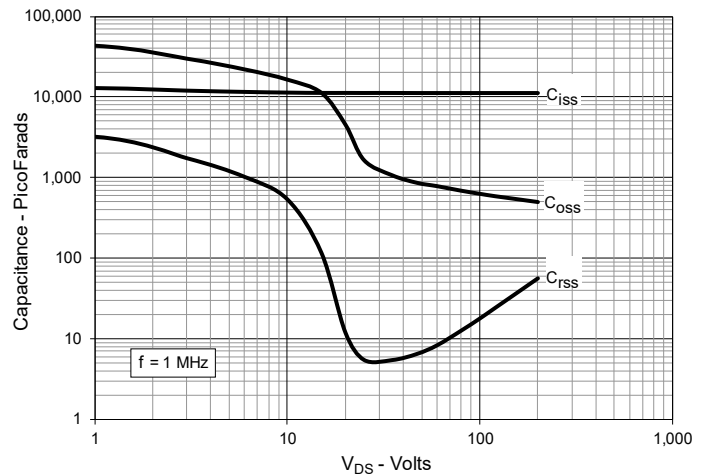
Fig. 12. Capacitance

Fig. 13. Output Capacitance Stored Energy

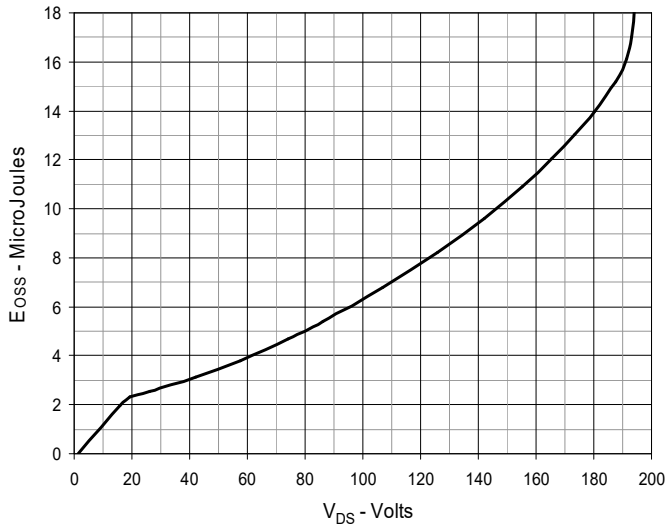

Fig. 14. Forward-Bias Safe Operating Area

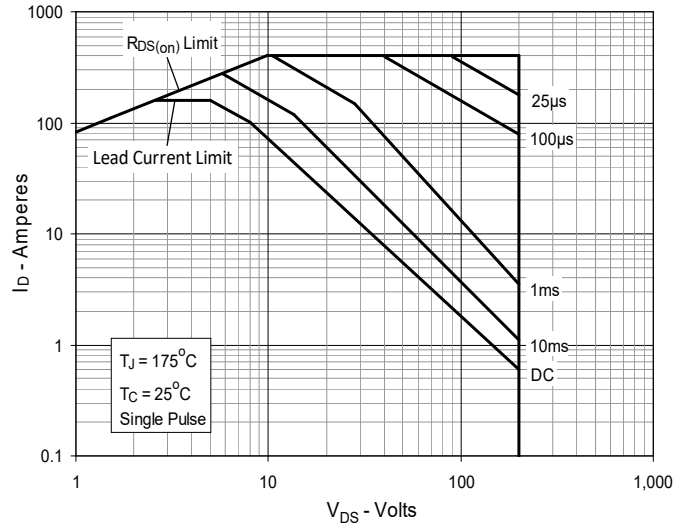
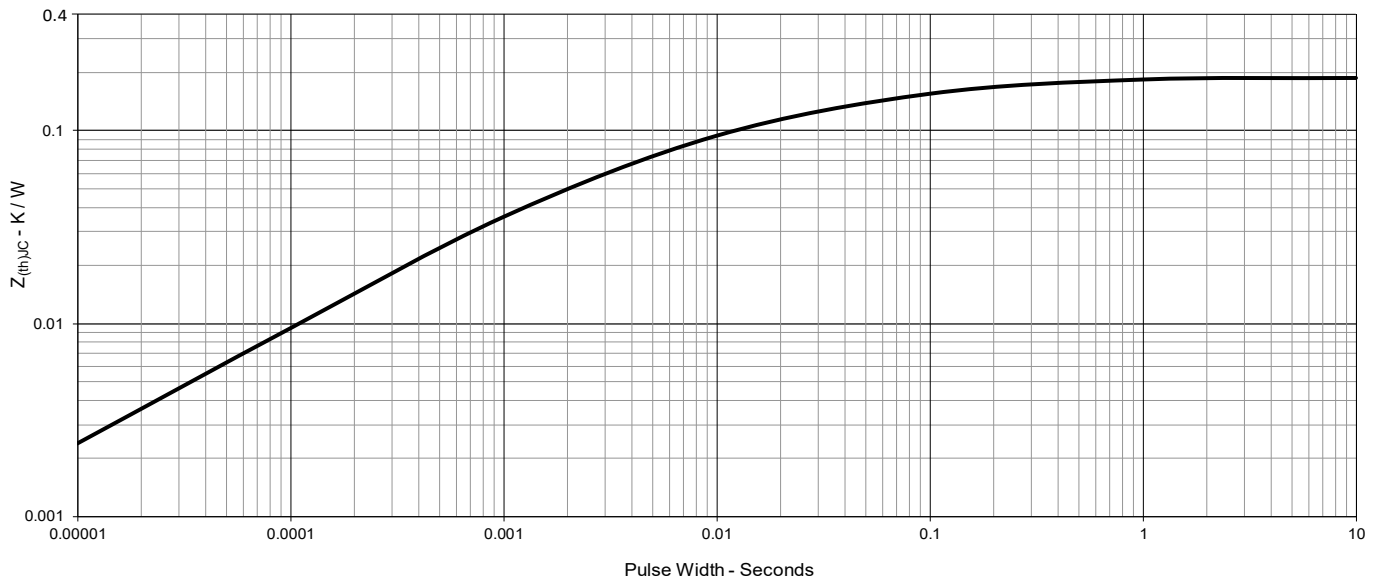
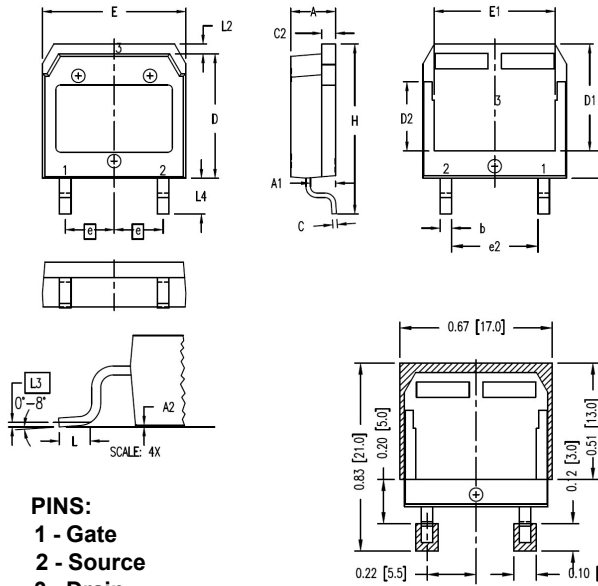

Fig. 15. Maximum Transient Thermal Impedance



TO-268HV Outline

PINS:

- 1 - Gate**
- 2 - Source**
- 3 - Drain**

SYM	INCHES		MILLIMETER	
	MIN	MAX	MIN	MAX
A	.193	.201	4.90	5.10
A1	.106	.114	2.70	2.90
A2	.001	.010	0.02	0.25
b	.045	.057	1.15	1.45
C	.016	.026	0.40	0.65
C2	.057	.063	1.45	1.60
D	.543	.551	13.80	14.00
D1	.465	.476	11.80	12.10
D2	.295	.307	7.50	7.80
D3	.114	.126	2.90	3.20
E	.624	.632	15.85	16.05
E1	.524	.535	13.30	13.60
\square e	.215 BSC		5.45 BSC	
(e2)	.374	.386	9.50	9.80
H	.736	.752	18.70	19.10
L	.067	.079	1.70	2.00
L2	.039	.045	1.00	1.15
\square L3	.010 BSC		0.25 BSC	
L4	.150	.161	3.80	4.10



Disclaimer Notice - Information furnished is believed to be accurate and reliable. However, users should independently evaluate the suitability of and test each product selected for their own applications. Littelfuse products are not designed for, and may not be used in, all applications. Read complete Disclaimer Notice at www.littelfuse.com/disclaimer-electronics.
