



Datasheet

RS PRO Cable Clamp 1/4"

Stock number: 172-0841

EN



DIMENSIONS	TOLERANCE
<4mm	±0.20
4mm~15mm	±0.30
15mm~30mm	±0.40
30mm~50mm	±0.50

REVISIONS			
REV	DESCRIPTION	DATE	BY
01	NEW DRAWING	2016-8-28	Jack Xu

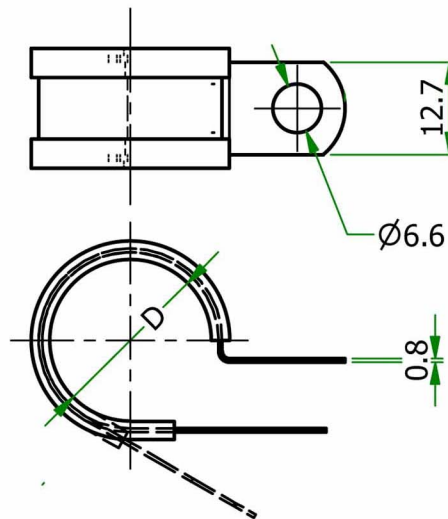

NOTES:

1.MATERIAL:

Cold Rolled Steel-- Silver

Cushion:RUBBER-- BLACK

2.HOLDING DIA. ØD=6.35mm

Unit:mm

SCALE	--	PART NAME	Hose Clamp
COLOR	SEE NOTES	PART NO.	172-0841
DRAWN	ALEX	MATERIAL	SEE NOTES
CHECK	JACK	DRAWING NO.	KS180710-2
APPROVED	GARY	DRAWING DATE	2016-8-28