

VALVE PLUG SUPPRESSOR FORM A - 18MM

RC and LED, 110VAC/DC/10VA/W

110 V AC/DC

RC + LED

Remove plug gasket when fitting adapter. Other LED colors on request.

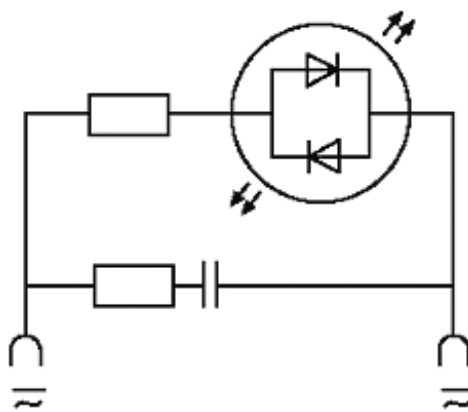
[Link to Product](#)**Illustration**

LED + RC

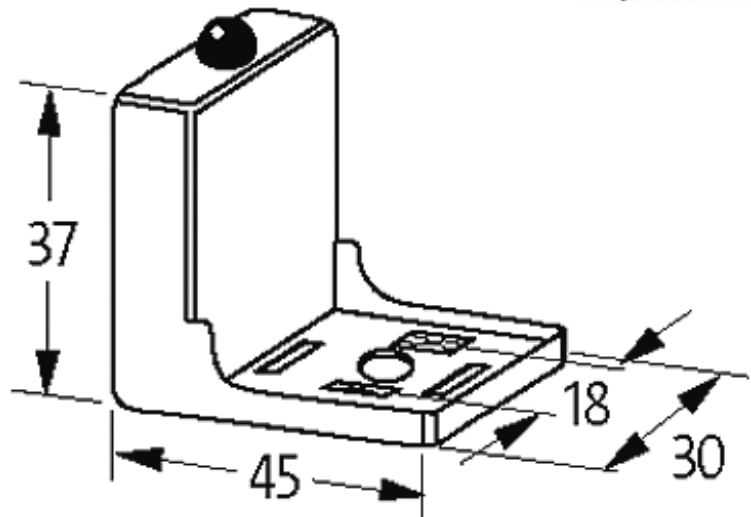

Product may differ from Image

Technical Data

LED display	(yellow opac)
Contact material	Silvered bronze
Material	Polyamide black, flame retardant, temperature resistance up to 130 °C
Switch off peak	max. 250 V
Switch off delay time	max. 20 ms
Max. power (W)	max. 10 W(VA)

General data

Temperature range	-20...+60 °C
Dimensions H × W × D	37×45×30 mm

Commercial data

country of origin	CZ
customs tariff number	85363010
minimum order quantity	1