

**Weld-Splatter Resistant Actuator and Sensor Cable**  
**Connection cable**  
**RKC4.5T-10/TXL1001**

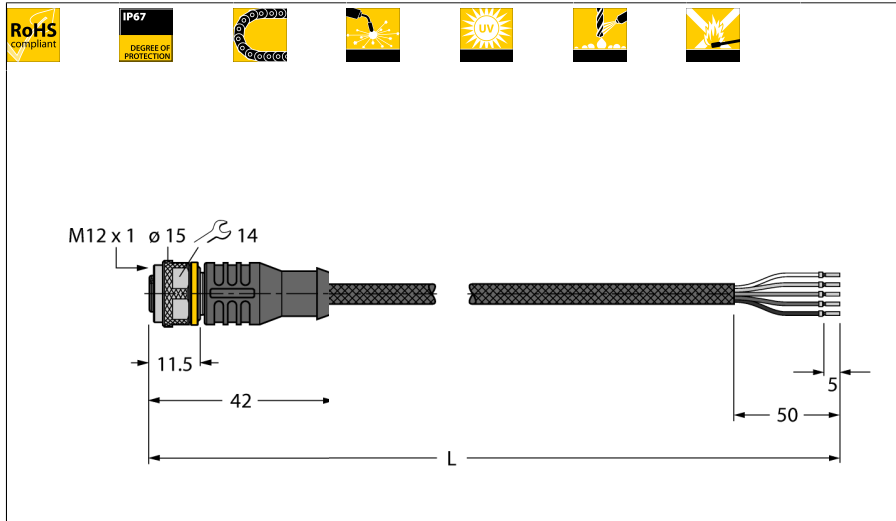

- Female M12, straight, 5-pin
- Jacket material: PUR jacketed with aramid
- Jacket color: yellow
- Resistant to welding sparks
- Flame-retardant
- Resistant to chemicals, UV radiation and oils
- Free from halogen, silicone, PVC and LABS
- RoHS-compliant
- Protection class IP67
- Protective jacket material: Aramid fibers
  - Tensile strength: 2923 MPa
  - Breaking strength: 333 N
  - Elongation at break: 3.6%
  - Temperature peaks: up to +200 °C
- Cable length: 10 m

<b>Type designation</b>	RKC4.5T-10/TXL1001
Ident no.	6630285

<b>Connector A side</b>	Female connector, M12 ♂ 1, Straight
Number of pins	5
Contacts	Brass, CuZn, Gold-plated
Contact carriers	Plastic, TPU, Black
Grip	Plastic, TPU, Black
Coupling nut/screw	Brass, CuZn, Nickel-plated
Seal	Plastic, FPM/FKM
Protection class	IP67, A + B side screwed together
Mechanical lifespan	> 100 Mating cycles
Pollution degree	3
Tightening torque	0.8 ... 1 Nm (observe max. torque of counter piece!)

<b>General data</b>	
Cable diameter	6.1 ± 0.20mm
Cable length	10 m
Cable quality	PUR
Cable color	Black
Core insulation	PP
Core colors	BN, WH, BU, BK, GY
Core cross-section	5x0.34mm <sup>2</sup>
Arrangement of strands	42x0.1 mm

<b>Electrical features at +20 °C</b>	
Current	4 A
Rated voltage	60 V
Insulation resistance	> 30.5 MΩ/km
Test voltage	2000 V
Forward resistance	max. 57 Ω/km

<b>Mechanical and chemical properties</b>	
Max. tensile strength (static)	≤ 50 N/mm <sup>2</sup>
Max. tensile strength (dynamic)	≤ 20 N/mm <sup>2</sup>
Bending radius (stationary laying)	> 5 x Ø
Bending radius (flexible use)	> 10 x Ø
Ambient temperature	
Stationary	-50...+105°C
In motion	-30...+90°C

**Cable Cross-section**

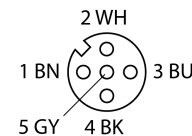
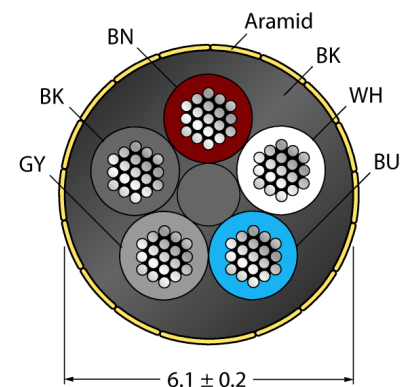

**General information**

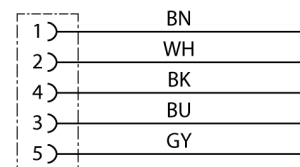

Drawing depicts design version including hexagon coupling nut  
(Production date after CW11/2016).

**Circuit Diagram**

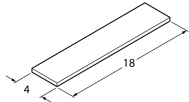
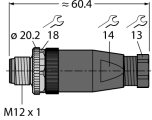
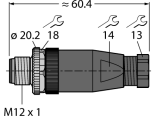

**Weld-Splatter Resistant Actuator and Sensor Cable**  
**Connection cable**  
**RKC4.5T-10/TXL1001**

**Accessories**

Type code	Ident no.	Description	
Torque-Wrench-Set-AS	6936170	Torque wrench set; handles with adjustable torque 0.4-1.0 Nm, torque wrench for M8 (SW9), fork wrench for M12 (SW 14)	
BLANK-LABEL-FOR-CORDSETS-TEL-TXL	6936206	Label for TEL and TXL cables, length: 18 mm, height: 4 mm, material: polycarbonate (PC), color: white, halogen-free and flame-retardant	
BS8151-0	6904611	Field-wireable male connector, M12  1, straight, 5-pin, screw terminal connection, cable feedthrough 4.0 to 6.0 mm, core cross-section/terminal capacity 0.14 to 0.75 mm <sup>2</sup> , plastic housing, metal nut	
BS8251-0	6904612	Field-wireable male connector, M12  1, angled, 5-pin, screw terminal connection, cable feedthrough 4.0 to 6.0 mm, core cross-section/terminal capacity 0.14 to 0.75 mm <sup>2</sup> , plastic housing, metal nut	