

Mounting Blocks · for index bolts and index plungers

22120.0352



Product Description

Assembly support and extended applications for index bolts.
Also usable for index plungers size 6, 8 and 10.

Material

Grub Screw

- Steel, blackened, with brass pad

Body

- Steel, blackened

Drawing

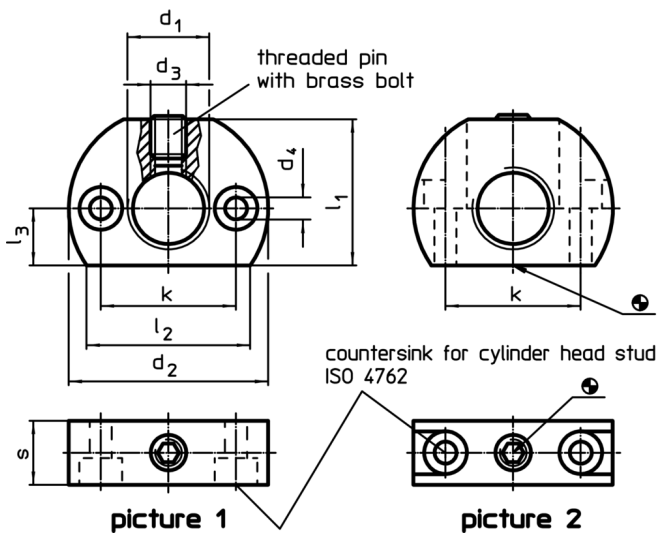

Order information

Dimensions									max. [°C]	[g]	Art. No.
d ₁	d ₂	d ₃	d ₄	k ±0.1	l ₁	l ₂ ~	l ₃	s			
mounting hole vertical to index bolt and index plunger – picture 2, steel											
M20 x 1,5	46	M8	5.5	32	33	38	13	15	250	94	22120.0352

Application example

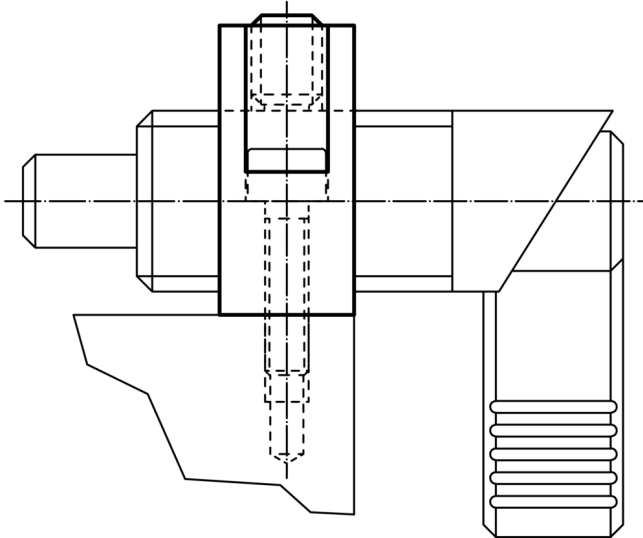

Compliance

RoHS compliant

Contains lead - compliant according to exceptions 6a / 6b / 6c

Contains SVHC substances >0,1% w/w

Contains lead - SVHC list [REACH] as of 10.06.2022

Contains Proposition 65 substances



Lead can cause cancer and reproductive harm from exposure
<https://www.P65Warnings.ca.gov/>

Free from Conflict Minerals

This product does not contain any substances designated as "conflict minerals" such as tantalum, tin, gold or tungsten from the Democratic Republic of Congo or adjacent countries.