

Power supply unit - QUINT4-PS/3AC/24DC/10 - 2904621

Please be informed that the data shown in this PDF Document is generated from our Online Catalog. Please find the complete data in the user's documentation. Our General Terms of Use for Downloads are valid (<http://phoenixcontact.com/download>)



Primary-switched QUINT POWER power supply with free choice of output characteristic curve, SFB (selective fuse breaking) technology, and NFC interface, input: 3-phase, output: 24 V DC/10 A

Product Description

The fourth generation of the high-performance QUINT POWER power supplies ensures superior system availability by means of new functions. Signaling thresholds and characteristic curves can be individually adjusted via the NFC interface. The unique SFB technology and preventive function monitoring of the QUINT POWER power supply increase the availability of your application.

Why buy this product

- SFB technology trips standard circuit breakers selectively, loads that are connected in parallel continue working
- Preventive function monitoring indicates critical operating states before errors occur
- Signaling thresholds and characteristic curves that can be adjusted via NFC maximize system availability
- Easy system extension thanks to static boost; starting of difficult loads thanks to dynamic boost
- High degree of immunity, thanks to integrated gas-filled surge arrester and mains failure bridging time of more than 20 milliseconds
- Robust design thanks to metal housing and wide temperature range from -40°C to +70°C
- Worldwide use thanks to the wide range input and international approval package



Key Commercial Data

Packing unit	1 STK
GTIN	 4 046356 986878
GTIN	4046356986878
Weight per Piece (excluding packing)	1,000.000 g
Custom tariff number	85044030
Country of origin	Thailand

Technical data

Dimensions

Width	50 mm
Height	130 mm
Depth	125 mm
Width with alternative assembly	122 mm

Power supply unit - QUINT4-PS/3AC/24DC/10 - 2904621

Technical data

Dimensions

Height with alternative assembly	130 mm
Depth with alternative assembly	53 mm

Ambient conditions

Degree of protection	IP20
Ambient temperature (operation)	-25 °C ... 70 °C (> 60 °C Derating: 2.5 %/K)
Ambient temperature (start-up type tested)	-40 °C
Ambient temperature (storage/transport)	-40 °C ... 85 °C
Max. permissible relative humidity (operation)	≤ 95 % (at 25 °C, non-condensing)
Climatic class	3K3 (in acc. with EN 60721)
Degree of pollution	2
Installation height	≤ 5000 m (> 2000 m, observe derating)

Input data

Nominal input voltage range	3x 400 V AC ... 500 V AC
	2x 400 V AC ... 500 V AC
	± 260 V DC ... 300 V DC
Input voltage range	3x 400 V AC ... 500 V AC -20 % ... +10 %
	2x 400 V AC ... 500 V AC -10 % ... +10 %
	± 260 V DC ... 300 V DC -13 % ... +30 %
AC frequency range	50 Hz ... 60 Hz -10 % ... +10 %
Discharge current to PE	< 3.5 mA
Current consumption	3x 0.5 A (400 V AC)
	3x 0.41 A (480 V AC)
	2x 1.1 A (400 V AC)
	2x 0.91 A (480 V AC)
	3x 0.4 A (500 V AC)
	2x 1.1 A (500 V AC)
Nominal power consumption	256 W
Inrush surge current	typ. 3 A (at 25 °C)
Power failure bypass	≥ 22 ms (3x 400 V AC)
	≥ 22 ms (3x 480 V AC)
Choice of suitable circuit breakers	3x 4 A ... 20 A (Characteristic B, C or comparable)
Type of protection	Transient surge protection
Protective circuit/component	Varistor, gas-filled surge arrester

Output data

Nominal output voltage	24 V DC
Setting range of the output voltage (U_{Set})	24 V DC ... 29.5 V DC (constant capacity)
Nominal output current (I_N)	10 A
Static Boost ($I_{Stat.Boost}$)	12.5 A
Dynamic Boost ($I_{Dyn.Boost}$)	20 A (5 s)

Power supply unit - QUINT4-PS/3AC/24DC/10 - 2904621

Technical data

Output data

Selective Fuse Breaking (I_{SFB})	60 A (15 ms)
Derating	> 60 °C (2.5%/K)
Connection in parallel	Yes, for redundancy and increased capacity
Connection in series	yes
Feedback resistance	≤ 35 V DC
Circuit breaker against surge voltage at output by invasive foreign matter	≤ 32 V DC
Control deviation	< 0.5 % (Static load change 10 % ... 90 %)
	< 2 % (Dynamic load change 10 % ... 90 %, (10 Hz))
	< 0.25 % (change in input voltage ±10 %)
Residual ripple	< 75 mV _{PP} (with nominal values)
Output power	240 W
Typical response time	300 ms (from SLEEP MODE)
Maximum power dissipation in no-load condition	< 5 W (400 V AC)
	< 5 W (480 V AC)
Power loss nominal load max.	< 19 W (400 V AC)
	< 20 W (480 V AC)

General

Net weight	0.9 kg
Efficiency	typ. 93 % (400 V AC)
	typ. 92.6 % (480 V AC)
Insulation voltage input/output	4 kV AC (type test)
	2.4 kV AC (routine test)
Insulation voltage input / PE	3.5 kV AC (type test)
	2.4 kV AC (routine test)
Insulation voltage output / PE	0.5 kV DC (type test)
	0.5 kV DC (routine test)
Protection class	I
Degree of protection	IP20
MTBF (IEC 61709, SN 29500)	> 1034000 h (25 °C)
	> 654000 h (40 °C)
	> 320000 h (60 °C)
Mounting position	horizontal DIN rail NS 35, EN 60715
Assembly instructions	alignable: $P_N \geq 50\%$, 5 mm horizontally, 15 mm next to active components, 50 mm vertically alignable: $P_N < 50\%$, 0 mm horizontally, 40 mm vertically top, 20 mm vertically bottom

Connection data, input

Connection method	Screw connection
Conductor cross section solid min.	0.2 mm ²
Conductor cross section solid max.	6 mm ²
Conductor cross section flexible min.	0.2 mm ²

Power supply unit - QUINT4-PS/3AC/24DC/10 - 2904621

Technical data

Connection data, input

Conductor cross section flexible max.	4 mm ²
Conductor cross section AWG min.	30
Conductor cross section AWG max.	10
Stripping length	8 mm

Connection data, output

Connection method	Screw connection
Conductor cross section solid min.	0.2 mm ²
Conductor cross section solid max.	2.5 mm ²
Conductor cross section flexible min.	0.2 mm ²
Conductor cross section flexible max.	2.5 mm ²
Conductor cross section AWG min.	30
Conductor cross section AWG max.	12
Stripping length	6.5 mm

Connection data for signaling

Connection method	Push-in connection
Conductor cross section solid min.	0.2 mm ²
Conductor cross section solid max.	1.5 mm ²
Conductor cross section flexible min.	0.2 mm ²
Conductor cross section flexible max.	1.5 mm ²
Conductor cross section AWG min.	24
Conductor cross section AWG max.	16
Stripping length	8 mm

Standards and Regulations

Electromagnetic compatibility	Conformance with EMC Directive 2014/30/EU
Noise emission	Additional basic standard EN 61000-6-5 (immunity in power station), IEC/EN 61850-3 (energy supply)
Noise immunity	Immunity according to EN 61000-6-1 (residential), EN 61000-6-2 (industrial), and EN 61000-6-5 (power station equipment zone), IEC/EN 61850-3 (energy supply)
Standards/regulations	EN 61000-4-2
Contact discharge	4 kV (Test Level 2)
Standards/regulations	EN 61000-4-3
Frequency range	80 MHz ... 1 GHz
Test field strength	10 V/m (Test Level 3)
Frequency range	1.4 GHz ... 2 GHz
Test field strength	3 V/m (Test Level 2)
Standards/regulations	EN 61000-4-4
Comments	Criterion B
Standards/regulations	EN 61000-4-5
Signal	0.5 kV (Test Level 1 - asymmetrical)

Power supply unit - QUINT4-PS/3AC/24DC/10 - 2904621

Technical data

Standards and Regulations

Standards/regulations	EN 61000-4-6
Frequency range	0.15 MHz ... 80 MHz
Voltage	10 V (Test Level 3)
Conducted noise emission	EN 55016 EN 61000-6-4 (Class A)
Standards/regulations	EN 61000-4-8
	EN 61000-4-11
	EN 61000-4-9
	EN 61000-4-12
	EN 61000-4-16
	EN 61000-4-18
Low Voltage Directive	Conformance with Low Voltage Directive 2014/35/EC
Standard - Safety of transformers	EN 61558-2-16 (air clearances and creepage distances only)
Standard - Electrical safety	IEC 60950-1/VDE 0805 (SELV)
Standard - power supply devices for low voltage with DC output	EN 61204-3
Standard – Electronic equipment for use in electrical power installations and their assembly into electrical power installations	EN 50178/VDE 0160 (PELV)
Standard – Safety extra-low voltage	IEC 60950-1 (SELV) and EN 60204-1 (PELV)
Standard - Safe isolation	DIN VDE 0100-410
Standard – Limitation of mains harmonic currents	EN 61000-3-2
Shipbuilding approval	DNV GL, PRS, BV, LR, ABS
UL approvals	UL Listed UL 508
	UL/C-UL Recognized UL 60950-1
	UL ANSI/ISA-12.12.01 Class I, Division 2, Groups A, B, C, D (Hazardous Location)
Shock	18 ms, 30g, in each space direction (according to IEC 60068-2-27)
Vibration (operation)	5 Hz - 100 Hz resonance search 2.3g, 90 min., resonance frequency 2.3g, 90 min. (according to DNV GL Class C)
Approval - requirement of the semiconductor industry with regard to mains voltage dips	SEMI F47-0706 Compliance Certificate; EN 61000-4-11
Rail applications	EN 50121-3-2
Overvoltage category (EN 60950-1)	II
Overvoltage category (EN 61010-1)	II
Overvoltage category (EN 62477-1)	III

Environmental Product Compliance

China RoHS	Environmentally Friendly Use Period = 25;
	For details about hazardous substances go to tab "Downloads", Category "Manufacturer's declaration"

Drawings

Power supply unit - QUINT4-PS/3AC/24DC/10 - 2904621

Block diagram

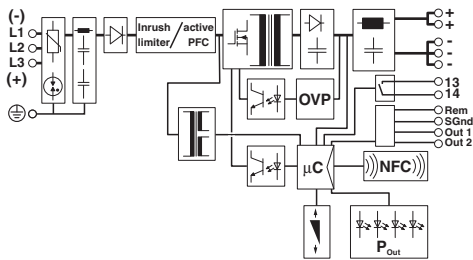

Diagram

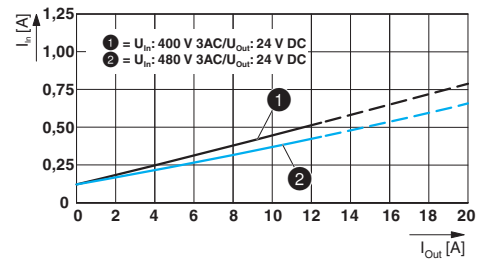

Diagram

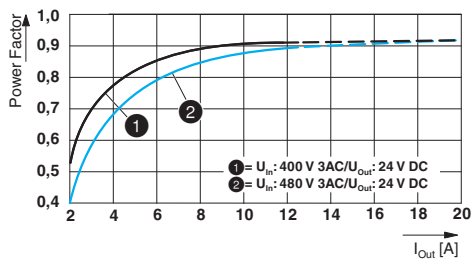

Diagram

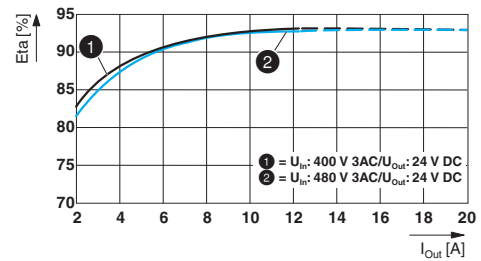

Diagram

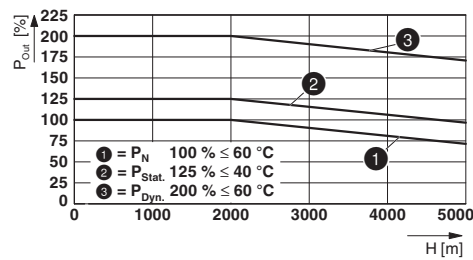

Dimensional drawing

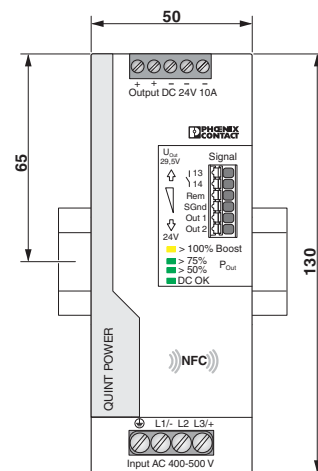

Power supply unit - QUINT4-PS/3AC/24DC/10 - 2904621

Dimensional drawing

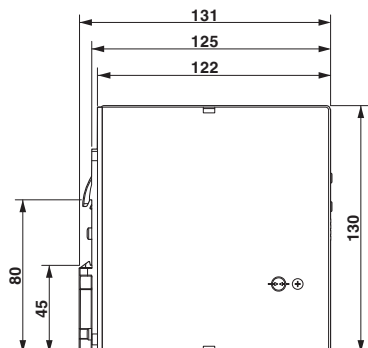

Schematic diagram

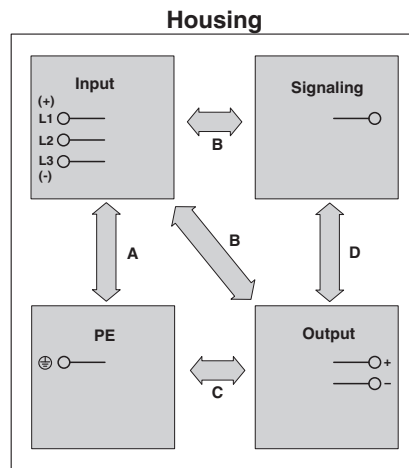

Classifications

eCl@ss

eCl@ss 5.1	27242213
eCl@ss 6.0	27049005
eCl@ss 8.0	27049002
eCl@ss 9.0	27040701

ETIM

ETIM 5.0	EC002540
ETIM 6.0	EC002540

UNSPSC

UNSPSC 13.2	39121004
-------------	----------

Approvals

Approvals

Approvals

UL Recognized / cUL Recognized / EAC / Bauartgeprüft / UL Listed / cUL Listed / DNV GL / ABS / cULus Listed

Ex Approvals

UL Listed / cUL Listed / cULus Listed

Approval details

Power supply unit - QUINT4-PS/3AC/24DC/10 - 2904621

Approvals

UL Recognized		http://database.ul.com/cgi-bin/XYV/template/LISEXT/1FRAME/index.htm	FILE E 211944
---------------	--	---	---------------

cUL Recognized		http://database.ul.com/cgi-bin/XYV/template/LISEXT/1FRAME/index.htm	FILE E 211944
----------------	--	---	---------------

EAC			RU C- DE.A*30.B.01082
-----	--	--	--------------------------

Bauartgeprüft			SI-SIQ BG 005/037
---------------	--	--	-------------------

UL Listed		http://database.ul.com/cgi-bin/XYV/template/LISEXT/1FRAME/index.htm	FILE E 123528
-----------	--	---	---------------

cUL Listed		http://database.ul.com/cgi-bin/XYV/template/LISEXT/1FRAME/index.htm	FILE E 123528
------------	--	---	---------------

DNV GL		http://exchange.dnv.com/tari/	TAA00000BV
--------	--	---	------------

ABS		http://www.eagle.org/eagleExternalPortalWEB/	17- HG1649297-1-PDA
-----	--	---	------------------------

cULus Listed		http://database.ul.com/cgi-bin/XYV/template/LISEXT/1FRAME/index.htm	
--------------	--	---	--

Accessories

Accessories

Assembly adapter

Assembly adapters - UWA 182/52 - 2938235



Universal wall adapter for securely mounting the power supply in the event of strong vibrations. The power supply is screwed directly onto the mounting surface. The universal wall adapter is attached at the top/bottom.

Power supply unit - QUINT4-PS/3AC/24DC/10 - 2904621

Accessories

Assembly adapters - UWA 130 - 2901664



2-piece universal wall adapter for securely mounting the power supply in the event of strong vibrations. The profiles that are screwed onto the side of the power supply are screwed directly onto the mounting surface. The universal wall adapter is attached on the left/right.

Assembly adapters - QUINT-PS-ADAPTERS7/1 - 2938196



Assembly adapter for QUINT-PS... power supply on S7-300 rail

Device protection

Type 3 surge protection device - PLT-SEC-T3-3S-230-FM - 2905230



Plug-in device protection, according to type 3/class III, for 3-phase power supply networks with separate N and PE (5-conductor system: L1, L2, L3, N, PE), with integrated surge-proof fuse and remote indication contact.

Fuse

Fuse - FUSE 10,3X38 6A PV A - 3062778



Fuse, for the photovoltaics industry according to UL 2579, length: 38 mm, diameter: 10.3 mm, color: white

Programming adapter

Programming adapter - TWN4 MIFARE NFC USB ADAPTER - 2909681



Near Field Communication (NFC) programming adapter with USB interface for the wireless configuration of NFC-capable products from PHOENIX CONTACT with software. No separate USB driver is required.
