



SIRIUS, EXPANSION MODULE 3RK32 FOR 3RK3 MODULAR SAFETY SYSTEM 4 F-DO, DC 24V/ 2 A
 PARAMETERIZABLE VIA SW MSS ES 22.5MM WIDTH SCREW TERMINAL UP TO SIL3 (IEC 61508) UP TO PERFORMANCE LEVEL E (ISO 13849-1)

General technical data:		
product brand name		SIRIUS
Product designation		Modular Safety System 3RK3
Design of the product		Expansion module 4 F-DO
Protection class IP		IP20
Shock resistance		15g / 11 ms
Degree of pollution		3
mounting position		vertical
Installation altitude at height above sea level maximum	m	2 000
Ambient temperature		
• during storage	°C	-40 ... +85
• during operation	°C	-20 ... +60
• during transport	°C	-40 ... +85
Relative humidity during operation	%	10 ... 95
Conducted interference due to burst acc. to IEC 61000-4-4		2 kV (power ports)
Conducted interference due to conductor-earth surge acc. to IEC 61000-4-5		2 kV
Conducted interference due to conductor-conductor surge acc. to IEC 61000-4-5		1 kV
Electrostatic discharge acc. to IEC 61000-4-2		4 kV contact discharge / 8 kV air discharge
Field-bound parasitic coupling acc. to IEC 61000-4-3		10 V/m, 3 V/m, 1 V/m
Surge voltage resistance Rated value	V	500
Insulation voltage Rated value	V	50

Equipment marking acc. to DIN 40719 extended according to IEC 204-2 acc. to IEC 750		K
Equipment marking acc. to DIN EN 61346-2		K
Product function		
• EMERGENCY OFF function		No
• protective door monitoring		No
• evaluation: electro-sensitive protective equipment		No
• evaluation: selector switch		No
• Pressure-sensitive mat monitoring		No
• evaluation: two-hand operator panel		No
• evaluation: enabling switch		No
• monitored start-up		No

Control circuit/ Control:

Type of voltage		DC
Control supply voltage 1 for DC Rated value	V	24
Operating range factor control supply voltage rated value of the magnet coil		0.85 ... 1.15

Auxiliary circuit:

Product function		
• Parameterizable outputs		Yes
Number of inputs		
• safety-related		0
• non-safety-related		0
Number of outputs		
• as contact-affected switching element safety-related		
— 1-channel		0
— 2-channel		0
• as contact-less semiconductor switching element		
— safety-related 2-channel		4
— non-safety-related 2-channel		0
• for testing contact-based sensors		0
Switching capacity current of semiconductor outputs at DC-13 at 24 V	A	2







Installation/ mounting/ dimensions:

Mounting type		standard rail
Width	mm	22.5
Height	mm	102
Depth	mm	124

Connections/ Terminals:

Product function removable terminal for auxiliary and control circuit		Yes
Type of electrical connection for auxiliary and control current circuit		screw-type terminals
Connectable conductor cross-section for auxiliary contacts		
<ul style="list-style-type: none"> • single or multi-stranded 	mm ²	0.5 ... 4
<ul style="list-style-type: none"> • finely stranded — with core end processing 	mm ²	0.5 ... 2.5

Certificates/ approvals:

General Product Approval					EMC
					
CCC	CSA	GOST	UL		C-TICK

Functional Safety/Safety of Machinery	Test Certificates	other			
Type Examination Certificate	other	Special Test Certificate	Environmental Confirmations	Confirmation	Declaration of Conformity

Safety related data:

Safety Integrity Level (SIL) acc. to IEC 61508		SIL3
Performance level (PL) acc. to EN ISO 13849-1		e
Category acc. to EN 954-1		4
PFHD with high demand rate acc. to EN 62061	1/h	0.0000000032
Average probability of failure on demand (PFDavg) with low demand rate acc. to IEC 61508	1/y	0.000022
T1 value for proof test interval or service life acc. to IEC 61508	y	20
Protection against electrical shock		finger-safe

Further information

Information- and Downloadcenter (Catalogs, Brochures,...)

<http://www.siemens.com/industrial-controls/catalogs>

Industry Mall (Online ordering system)

<http://www.siemens.com/industrymall>

Cax online generator

<http://support.automation.siemens.com/WW/CAXorder/default.aspx?lang=en&mlfb=3RK32421AA10>

Service&Support (Manuals, Certificates, Characteristics, FAQs,...)

<http://support.automation.siemens.com/WW/view/en/3RK32421AA10/all>

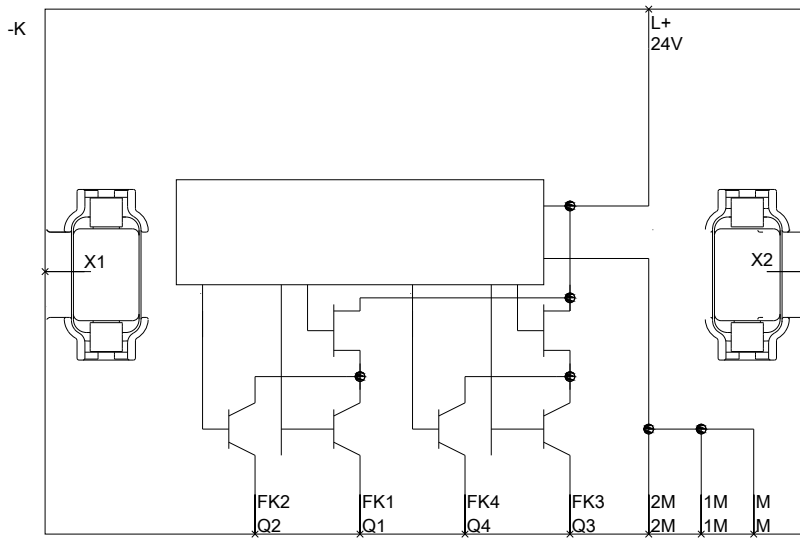
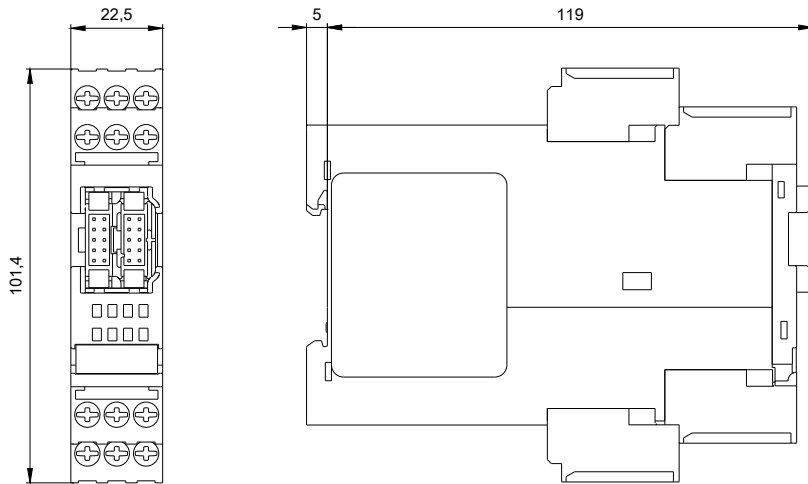

last modified:

15.01.2015