

Product information

20 01 125

- Flat, short, wide jaws
- Knurled gripping surfaces
- Special tool steel, forged, oil-hardened

Flat Nose Pliers

DIN ISO 5745



General

Article No.	20 01 125
EAN	4003773033875
Pliers	black atramentized
Head	polished
Handles	plastic coated
Weight	80 g
Dimensions	125 x 51 x 11 mm
Standard	DIN ISO 5745
REACH compliant	does not contain SVHC
RoHS compliant	not applicable

Technical details

Jaw thickness (joint) (T1)	8.0 mm
Jaw length (L3)	27.0 mm
Head width (W3)	14.5 mm

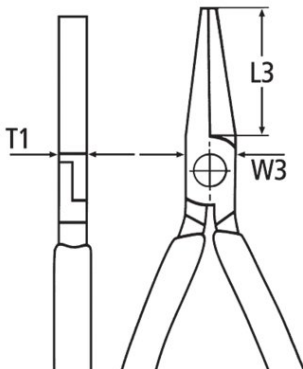

technical change and errors excepted

