



**Robert Bosch Power Tools GmbH**  
70538 Stuttgart  
GERMANY

[www.bosch-pt.com](http://www.bosch-pt.com)

**1 609 92A 1WU** (2013.06) AS / 39 ASIA



1 609 92A 1WU

## GSB 10,8-2-LI Professional



- en** Original instructions
- cn** 正本使用说明书
- tw** 原始使用說明書
- ko** 사용 설명서 원본
- th** หนังสือคู่มือการใช้งานฉบับต้นแบบ
- id** Petunjuk-Petunjuk untuk Penggunaan Orisinal
- vi** Bản gốc hướng dẫn sử dụng



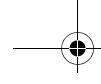

English ..... Page 3  
 中文 ..... 页 7  
 中文 ..... 頁 11  
 한국어 ..... 면 14  
 ภาษาไทย..... หน้า 18  
 Bahasa Indonesia ..... Halaman 23  
 Tiếng Việt ..... Trang 28

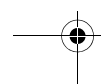
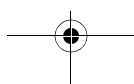
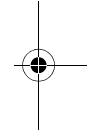
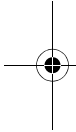

## English

### General Power Tool Safety Warnings

**⚠ WARNING** Read all safety warnings and all instructions. Failure to follow the warnings and instructions may result in electric shock, fire and/or serious injury.

#### Save all warnings and instructions for future reference.

The term "power tool" in the warnings refers to your mains-operated (corded) power tool or battery-operated (cordless) power tool.

#### Work area safety

- ▶ **Keep work area clean and well lit.** Cluttered or dark areas invite accidents.
- ▶ **Do not operate power tools in explosive atmospheres, such as in the presence of flammable liquids, gases or dust.** Power tools create sparks which may ignite the dust or fumes.
- ▶ **Keep children and bystanders away while operating a power tool.** Distractions can cause you to lose control.

#### Electrical safety

- ▶ **Power tool plugs must match the outlet. Never modify the plug in any way. Do not use any adapter plugs with earthed (grounded) power tools.** Unmodified plugs and matching outlets will reduce risk of electric shock.
- ▶ **Avoid body contact with earthed or grounded surfaces, such as pipes, radiators, ranges and refrigerators.** There is an increased risk of electric shock if your body is earthed or grounded.
- ▶ **Do not expose power tools to rain or wet conditions.** Water entering a power tool will increase the risk of electric shock.
- ▶ **Do not abuse the cord. Never use the cord for carrying, pulling or unplugging the power tool. Keep cord away from heat, oil, sharp edges and moving parts.** Damaged or entangled cords increase the risk of electric shock.
- ▶ **When operating a power tool outdoors, use an extension cord suitable for outdoor use.** Use of a cord suitable for outdoor use reduces the risk of electric shock.
- ▶ **If operating a power tool in a damp location is unavoidable, use a residual current device (RCD) protected supply.** Use of an RCD reduces the risk of electric shock.

#### Personal safety

- ▶ **Stay alert, watch what you are doing and use common sense when operating a power tool. Do not use a power tool while you are tired or under the influence of drugs, alcohol or medication.** A moment of inattention while operating power tools may result in serious personal injury.
- ▶ **Use personal protective equipment. Always wear eye protection.** Protective equipment such as dust mask, non-skid safety shoes, hard hat, or hearing protection used for appropriate conditions will reduce personal injuries.

- ▶ **Prevent unintentional starting. Ensure the switch is in the off-position before connecting to power source and/or battery pack, picking up or carrying the tool.**

Carrying power tools with your finger on the switch or energising power tools that have the switch on invites accidents.

- ▶ **Remove any adjusting key or wrench before turning the power tool on.** A wrench or a key left attached to a rotating part of the power tool may result in personal injury.
- ▶ **Do not overreach. Keep proper footing and balance at all times.** This enables better control of the power tool in unexpected situations.
- ▶ **Dress properly. Do not wear loose clothing or jewellery. Keep your hair, clothing and gloves away from moving parts.** Loose clothes, jewellery or long hair can be caught in moving parts.
- ▶ **If devices are provided for the connection of dust extraction and collection facilities, ensure these are connected and properly used.** Use of dust collection can reduce dust-related hazards.

#### Power tool use and care

- ▶ **Do not force the power tool. Use the correct power tool for your application.** The correct power tool will do the job better and safer at the rate for which it was designed.
- ▶ **Do not use the power tool if the switch does not turn it on and off.** Any power tool that cannot be controlled with the switch is dangerous and must be repaired.
- ▶ **Disconnect the plug from the power source and/or the battery pack from the power tool before making any adjustments, changing accessories, or storing power tools.** Such preventive safety measures reduce the risk of starting the power tool accidentally.
- ▶ **Store idle power tools out of the reach of children and do not allow persons unfamiliar with the power tool or these instructions to operate the power tool.** Power tools are dangerous in the hands of untrained users.
- ▶ **Maintain power tools. Check for misalignment or binding of moving parts, breakage of parts and any other condition that may affect the power tool's operation. If damaged, have the power tool repaired before use.** Many accidents are caused by poorly maintained power tools.
- ▶ **Keep cutting tools sharp and clean.** Properly maintained cutting tools with sharp cutting edges are less likely to bind and are easier to control.
- ▶ **Use the power tool, accessories and tool bits etc. in accordance with these instructions, taking into account the working conditions and the work to be performed.** Use of the power tool for operations different from those intended could result in a hazardous situation.

#### Battery tool use and care

- ▶ **Recharge only with the charger specified by the manufacturer.** A charger that is suitable for one type of battery pack may create a risk of fire when used with another battery pack.

## 4 | English

- ▶ **Use power tools only with specifically designated battery packs.** Use of any other battery packs may create a risk of injury and fire.
- ▶ **When battery pack is not in use, keep it away from other metal objects, like paper clips, coins, keys, nails, screws or other small metal objects, that can make a connection from one terminal to another.** Shorting the battery terminals together may cause burns or a fire.
- ▶ **Under abusive conditions, liquid may be ejected from the battery; avoid contact. If contact accidentally occurs, flush with water. If liquid contacts eyes, additionally seek medical help.** Liquid ejected from the battery may cause irritation or burns.
- ▶ **In case of damage and improper use of the battery, vapours may be emitted. Ventilate the area and seek medical help in case of complaints.** The vapours can irritate the respiratory system.
- ▶ **Use the battery only in conjunction with your Bosch power tool.** This measure alone protects the battery against dangerous overload.
- ▶ **Use only original Bosch batteries with the voltage listed on the nameplate of your power tool.** When using other batteries, e.g. imitations, reconditioned batteries or other brands, there is danger of injury as well as property damage through exploding batteries.

## Service

- ▶ **Have your power tool serviced by a qualified repair person using only identical replacement parts.** This will ensure that the safety of the power tool is maintained.

## Safety Warnings for Drills and Screwdriver

- ▶ **Wear ear protectors when impact drilling.** Exposure to noise can cause hearing loss.
- ▶ **Use auxiliary handle(s), if supplied with the tool.** Loss of control can cause personal injury.
- ▶ **Hold power tool by insulated gripping surfaces, when performing an operation where the cutting accessory or fastener may contact hidden wiring.** Cutting accessory and fasteners contacting a "live" wire may make exposed metal parts of the power tool "live" and could give the operator an electric shock.
- ▶ **Use appropriate detectors to determine if utility lines are hidden in the work area or call the local utility company for assistance.** Contact with electric lines can lead to fire and electric shock. Damaging a gas line can lead to explosion. Penetrating a water line causes property damage.
- ▶ **Switch off the power tool immediately when the tool insert jams. Be prepared for high reaction torque that can cause kickback.** The tool insert jams when:
  - the power tool is subject to overload or
  - it becomes wedged in the workpiece.
- ▶ **Hold the machine with a firm grip.** High reaction torque can briefly occur while driving in and loosening screws.
- ▶ **Secure the workpiece.** A workpiece clamped with clamping devices or in a vice is held more secure than by hand.
- ▶ **Always wait until the machine has come to a complete stop before placing it down.** The tool insert can jam and lead to loss of control over the power tool.
- ▶ **Do not open the battery.** Danger of short-circuiting.



**Protect the battery against heat, e. g., against continuous intense sunlight, fire, water, and moisture.** Danger of explosion.













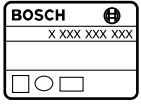



## Additional Safety and Working Instructions







- ▶ **Dusts from materials such as lead-containing coatings, some wood types, minerals and metal can be harmful to one's health and cause allergic reactions, lead to respiratory infections and/or cancer.** Materials containing asbestos may only be worked by specialists.
  - Provide for good ventilation of the working place.
  - It is recommended to wear a P2 filter-class respirator.
 Observe the relevant regulations in your country for the materials to be worked.
- ▶ **Prevent dust accumulation at the workplace.** Dusts can easily ignite.
- ▶ **Before any work on the machine (e. g., maintenance, tool change, etc.) as well as during transport and storage, set the rotational direction switch to the centre position.** Unintentional actuation of the On/Off switch can lead to injuries.
- ▶ **The battery is supplied partially charged. To ensure full battery capacity, completely charge the battery in the battery charger before using for the first time.**
- ▶ **Read the operating instructions of the battery charger.**
- ▶ **Apply the power tool to the screw only when it is switched off.** Rotating tool inserts can slip off.
- ▶ **Adjust the gear switch only when the machine is at a complete stop.**
- ▶ **If the gear switch cannot be pushed to the stop, turn the drill chuck a little.**
- ▶ The battery charge-control indicator consists of three green LEDs, and indicates the charge condition of the battery for a few seconds when the On/Off switch is pressed halfway or fully.

LED	Capacity
Continuous lighting 3 x green	≥ 2/3
Continuous lighting 2 x green	≥ 1/3
Continuous lighting 1 x green	< 1/3
Flashing light 1 x green	Reserve

## Symbols

The following symbols are important for reading and understanding the operating instructions. Please take note of the symbols and their meaning. The correct interpretation of the symbols will help you to use the machine in a better and safer manner.

Symbol	Meaning
	GSB 10,8-2-Li: Combination Cordless Drill Grey-marked area: Handle (insulated gripping surface)
	Article number
	Read all safety warnings and all instructions
	Before any work on the machine itself, remove the battery
	Always wear ear protection.
	Movement direction
	Reaction direction
	Right/left rotation
	Screwdriving
	Drilling without impact
	Impact drilling
	Low speed
	High speed
	Switching On
	Switching Off

Symbol	Meaning
	Battery Charge Indicator
U	Rated voltage
n <sub>0 1</sub>	No-load speed (1. gear)
n <sub>0 2</sub>	No-load speed (2. gear)
n <sub>s</sub>	Impact rate
M	Maximum torque according to ISO 5393
	Brickwork
	Metal
	Wood
∅	Drilling diameter, max.
	Max. screw dia.
	Chuck clamping range
	Weight according to EPTA-Procedure 01:2014
*	dependent of the battery pack being used

## Delivery Scope

Combination cordless drill.  
Battery, application tools and other accessories shown or described are not part of the standard delivery scope.  
A complete overview of accessories can be found in our accessories program.

## Intended Use

The machine is intended for driving in and loosening screws as well as for drilling in wood, metal, ceramic and plastic and for impact drilling in brick, brickwork and masonry.

## Technical Data

The technical data of the machine are listed in the table on page 33.  
Please observe the article number on the type plate of your machine. The trade names of the individual machines may vary.

## 6 | English

**Mounting and Operation**

Action	Figure	Page
Removing the battery	1	34
Inserting the battery	2	34
Mounting application tools	3	34
Reversing the rotational direction	4	35
Setting the torque	5	35
Setting the operating mode	6	36
Gear selection, mechanical	7	36
Switching On and Off	8	37
Checking the battery charge condition	9	37
Selecting Accessories	-	38

**Maintenance and Cleaning**

- **For safe and proper working, always keep the machine and ventilation slots clean.**

**After-sales Service and Application Service**

Our after-sales service responds to your questions concerning maintenance and repair of your product as well as spare parts. Exploded views and information on spare parts can also be found under:

**www.bosch-pt.com**

Bosch's application service team will gladly answer questions concerning our products and their accessories.

In all correspondence and spare parts order, please always include the 10-digit article number given on the type plate of the machine.

**People's Republic of China****China Mainland**

Bosch Power Tools (China) Co., Ltd.  
567, Bin Kang Road  
Bin Jiang District 310052  
Hangzhou, P.R. China  
Service Hotline: 4008268484  
Fax: (0571) 87774502  
E-Mail: contact.ptcn@cn.bosch.com  
www.bosch-pt.com.cn

**HK and Macau Special Administrative Regions**

Robert Bosch Hong Kong Co. Ltd.  
21st Floor, 625 King's Road  
North Point, Hong Kong  
Customer Service Hotline: +852 2101 0235  
Fax: +852 2590 9762  
E-Mail: info@hk.bosch.com  
www.bosch-pt.com.hk

**Indonesia**

PT. Multi Mayaka  
Kawasan Industri Pulogadung  
Jalan Rawa Gelam III No. 2

Jakarta 13930  
Indonesia  
Tel.: (021) 46832522  
Fax: (021) 46828645/6823  
E-Mail: sales@multimayaka.co.id  
www.bosch-pt.co.id

**Philippines**

Robert Bosch, Inc.  
28th Floor Fort Legend Towers,  
3rd Avenue corner 31st Street,  
Fort Bonifacio Global City,  
1634 Taguig City, Philippines  
Tel.: (02) 8703871  
Fax: (02) 8703870  
matheus.contiero@ph.bosch.com  
www.bosch-pt.com.ph  
Bosch Service Center:  
9725-27 Kamagong Street  
San Antonio Village  
Makati City, Philippines  
Tel.: (02) 8999091  
Fax: (02) 8976432  
rosalie.dagdagan@ph.bosch.com

**Malaysia**

Robert Bosch (S.E.A.) Sdn. Bhd.  
No. 8A, Jalan 13/6  
G.P.O. Box 10818  
46200 Petaling Jaya  
Selangor, Malaysia  
Tel.: (03) 79663194  
Fax: (03) 79583838  
cheehoe.on@my.bosch.com  
Toll-Free: 1800 880188  
www.bosch-pt.com.my

**Thailand**

Robert Bosch Ltd.  
Liberty Square Building  
No. 287, 11 Floor  
Silom Road, Bangrak  
Bangkok 10500  
Tel.: 02 6393111, 02 6393118  
Fax: 02 2384783

Robert Bosch Ltd., P. O. Box 2054  
Bangkok 10501, Thailand  
www.bosch.co.th

Bosch Service – Training Centre  
La Salle Tower Ground Floor Unit No.2  
10/11 La Salle Moo 16  
Srinakharin Road  
Bangkaew, Bang Plee  
Samutprakarn 10540  
Thailand  
Tel.: 02 7587555  
Fax: 02 7587525

#### Singapore

Robert Bosch (SEA) Pte. Ltd.  
11 Bishan Street 21  
Singapore 573943  
Tel.: 6571 2772  
Fax: 6350 5315  
leongheng.leow@sg.bosch.com  
Toll-Free: 1800 3338333  
www.bosch-pt.com.sg

#### Vietnam

Robert Bosch Vietnam Co. Ltd  
10/F, 194 Golden Building  
473 Dien Bien Phu Street  
Ward 25, Binh Thanh District  
84 Ho Chi Minh City  
Vietnam  
Tel.: (08) 6258 3690 ext. 413  
Fax: (08) 6258 3692  
hieu.lagia@vn.bosch.com  
www.bosch-pt.com

#### Australia, New Zealand and Pacific Islands

Robert Bosch Australia Pty. Ltd.  
Power Tools  
Locked Bag 66  
Clayton South VIC 3169  
Customer Contact Center  
Inside Australia:  
Phone: (01300) 307044  
Fax: (01300) 307045  
Inside New Zealand:  
Phone: (0800) 543353  
Fax: (0800) 428570  
Outside AU and NZ:  
Phone: +61 3 95415555  
www.bosch.com.au

### Transport

The contained lithium ion batteries are subject to the Dangerous Goods Legislation requirements. The user can transport the batteries by road without further requirements. When being transported by third parties (e.g.: air transport or forwarding agency), special requirements on packaging and labelling must be observed. For preparation of the item being

shipped, consulting an expert for hazardous material is required.

Dispatch batteries only when the housing is undamaged. Tape or mask off open contacts and pack up the battery in such a manner that it cannot move around in the packaging. Please also observe possibly more detailed national regulations.

### Disposal

 The machine, rechargeable batteries, accessories and packaging should be sorted for environmental-friendly recycling.

Do not dispose of power tools and batteries/rechargeable batteries into household waste!

#### Battery packs/batteries:

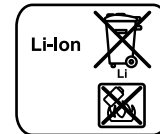

**Li-ion:**  
Please observe the instructions in section "Transport", page 7.

Subject to change without notice.

## 中文

### 电动工具通用安全警告

 **警告** 阅读所有警告和所有说明！不遵照以下警告和说明会导致电击、着火和/或严重伤害。

保存所有警告和说明书以备查阅。

在所有下列的警告中术语 "电动工具" 指市电驱动 (有线) 电动工具或电池驱动 (无线) 电动工具。

#### 工作场地的安全

- ▶ 保持工作场地清洁和明亮。混乱和黑暗的场地会引发事故。
- ▶ 不要在易爆环境，如有易燃液体、气体或粉尘的环境下操作电动工具。电动工具产生的火花会点燃粉尘或气体。
- ▶ 让儿童和旁观者离开后操作电动工具。注意力不集中会使操作者失去对工具的控制。

#### 电气安全

- ▶ 电动工具插头必须与插座相配。绝不能以任何方式改装插头。需接地的电动工具不能使用任何转换插头。未经改装的插头和相配的插座将减少电击危险。
- ▶ 避免人体接触接地表面，如管道、散热片和冰箱。如果你身体接地会增加电击危险。

## 8 | 中文

- ▶ **不得将电动工具暴露在雨中或潮湿环境中。** 水进入电动工具将增加电击危险。
- ▶ **不得滥用电线。** 绝不用电线搬运、拉动电动工具或拔出其插头。使电线远离热源、油、锐边或运动部件。受损或缠绕的软线会增加电击危险。
- ▶ **当在户外使用电动工具时，使用适合户外使用的外接软线。** 适合户外使用的软线将减少电击危险。
- ▶ **如果在潮湿环境下操作电动工具是不可避免的，应使用剩余电流动作保护器 (RCD)。** 使用 RCD 可减小电击危险。

## 人身安全

- ▶ **保持警觉，当操作电动工具时关注所从事的操作并保持清醒。** 当你感到疲倦，或在有药物、酒精或治疗反应时，不要操作电动工具。在操作电动工具时瞬间的疏忽会导致严重人身伤害。
- ▶ **使用个人防护装置。始终佩戴护目镜。** 安全装置，诸如适当条件下使用防尘面具、防滑安全鞋、安全帽、听力防护等装置能减少人身伤害。
- ▶ **防止意外起动。确保开关在连接电源和 / 或电池盒、拿起或搬运工具时处于关断位置。** 手指放在已接通电源的开关上或开关处于接通时插入插头可能会导致危险。
- ▶ **在电动工具接通之前，拿掉所有调节钥匙或扳手。** 遗留在电动工具旋转零件上的扳手或钥匙会导致人身伤害。
- ▶ **手不要伸展得太长。时刻注意立足点和身体平衡。** 这样在意外情况下能很好地控制电动工具。
- ▶ **着装适当。不要穿宽松衣服或佩戴饰品。** 让你的衣服、手套和头发远离运动部件。宽松衣服、配饰或长发可能会卷入运动部件中。
- ▶ **如果提供了与排屑、集尘设备连接的装置，要确保他们连接完好且使用得当。** 使用这些装置可减少尘屑引起的危险。

## 电动工具使用和注意事项

- ▶ **不要滥用电动工具，根据用途使用适当的电动工具。** 选用适当设计的电动工具会使你工作更有效、更安全。
- ▶ **如果开关不能接通或关断工具电源，则不能使用该电动工具。** 不能用开关来控制的电动工具是危险的且必须进行修理。
- ▶ **在进行任何调节、更换附件或贮存电动工具之前，必须从电源上拔掉插头和 / 或使电池盒与工具脱开。** 这种防护性措施将减少工具意外起动的危险。
- ▶ **将闲置不用的电动工具贮存在儿童所及范围之外，并且不要让不熟悉电动工具或对这些说明不了解的人操作电动工具。** 电动工具在未经培训的用户手中是危险的。
- ▶ **保养电动工具。检查运动件是否调整到位或卡住，检查零件破损情况和影响电动工具运行的其他状况。**

如有损坏，电动工具应在使用前修理好。许多事故由维护不良的电动工具引发。

- ▶ **保持切削刀具锋利和清洁。** 保养良好的有锋利切削刃的刀具不易卡住而且容易控制。
- ▶ **按照使用说明书，考虑作业条件和进行的作业来使用电动工具、附件和工具的刀头。** 将电动工具用于那些与其用途不符的操作可能会导致危险。

## 电池式工具使用和注意事项

- ▶ **只用制造商规定的充电器充电。** 将适用于某种电池盒的充电器用到其他电池盒时会发生着火危险。
- ▶ **只有在配有专用电池盒的情况下才使用电动工具。** 使用其他电池盒会发生损坏和着火危险。
- ▶ **当电池盒不用时，将它远离其他金属物体，例如回形针、硬币、钥匙、钉子、螺钉或其他小金属物体，以防一端与另一端连接。** 电池端部短路会引起燃烧或火灾。
- ▶ **在滥用条件下，液体会从电池中溅出，避免接触。** 如果意外碰到了，用水冲洗。如果液体碰到了眼睛，还要寻求医疗帮助。从电池中溅出的液体会发生腐蚀或燃烧。

## 维修

- ▶ **将你的电动工具送交专业维修人员，使用同样的备件进行修理。** 这样将确保所维修的电动工具的安全性。

## 针对电钻和电动扳手的安规规章

- ▶ **使用冲击电钻时要戴好耳罩。** 暴露在噪声中会引起听力损伤。
- ▶ **如果电动工具提供了辅助手柄便要使用它。** 操作时失控可能导致伤害。
- ▶ **安装在机器上的工具或螺丝如果可能割断隐藏的电线，一定要按住绝缘手柄操作电动工具。** 电动工具如果割断了带电的电线，机器上的金属部件会导电，并进而导致操作者触电。
- ▶ **使用合适的侦测器，以便找出隐藏着的电源线的位置。或者向当地的供电单位索取相关资料。** 钻穿电线会造成火灾并遭受电击。损坏瓦斯管会引起爆炸。如果水管被刺穿了会导致财物损失。
- ▶ **如果安装在机器上的工具被夹住了，必须马上关闭电动工具并保持镇静。此时机器会产生极高的反应力矩，并进而造成回击。** 安装在机器上的工具容易被夹住如果：
  - 电动工具超荷了，或者
  - 安装在机器上的工具在工件中歪斜了。
- ▶ **务必握紧电动工具。** 在拧紧和放松螺丝时，可能出现短暂的强大反击。
- ▶ **固定好工件。** 使用固定装置或老虎钳固定工件，会比手持握工件更牢固。



- ▶ **等待电动工具完全静止后才能够放下机器。** 机器上的工具可能在工作中被夹住，而令您无法控制电动工具。
- ▶ **切勿打开蓄电池。** 可能造成短路。
- ▶ **保护蓄电池免受高温（例如长期日照），火焰，水和湿气的侵害。** 有爆炸的危险。
- ▶ **如果蓄电池损坏了，或者未按照规定使用蓄电池，蓄电池中会散发出有毒蒸汽。** 工作场所必须保持空气流通，如果身体有任何不适必须马上就医。蓄电池散发的蒸汽会刺激呼吸道。
- ▶ **本蓄电池只能配合博世的电动工具一起使用。** 这样才能确保蓄电池不会过载。
- ▶ **只能使用博世原厂的蓄电池。** 电池的电压必须和电动工具铭牌上规定的电压相符。使用其他的蓄电池，例如仿制品、经过改造或其它品牌的蓄电池，有受伤的危险以及因为蓄电池爆炸而造成的财物损失。

### 进一步的安全规章和工作指示

- ▶ **含铅的颜料以及某些木材、矿物和金属的加工粉尘有害健康、可能造成过敏、让操作者感染呼吸道疾病和 / 或罹患癌症。** 只有经过专业训练的人员才能够加工含石棉的物料。
  - 工作场所要保持空气流通。
  - 最好佩戴 P2 滤网等级的口罩。
- ▶ **请留心并遵守贵国和加工物料有关的法规。**
- ▶ **避免让工作场所堆积过多的尘垢。** 尘埃容易被点燃。
- ▶ **维修电动工具、更换电动工具上的工具或者搬运电动工具时，务必把正逆转开关调整到中央的位置。** 如果不小心启动起停开关，可能造成伤害。
- ▶ **交货时蓄电池只完成部分充电，为了确保能够发挥电池的最大功率，首度使用前必须把蓄电池放入充电器中充足电。**
- ▶ **阅读充电器的使用说明书。**
- ▶ **确定电动工具已经关闭了，才可以把电动工具顶在螺丝头上。** 转动中的起子头容易从螺丝头上滑开。
- ▶ **待电动工具完全静止后才能够启动选档开关。**
- ▶ **如果无法把选档开关推到尽头，可以稍微转动夹头。**
- ▶ **在半按下或完全按下起停开关时，由 3 个绿色 LED 灯组成的蓄电池电量显示装置会以数秒钟的时间显示目前的蓄电池电量。**

LED	容量
3 个绿灯持续亮着	≥ 2/3
2 个绿灯持续亮着	≥ 1/3
1 个绿灯持续亮着	< 1/3
1 个绿灯闪烁	备用电量

### 代表符号

以下的符号可以帮助您正确地使用本机器。请详细阅读各符号及它们的代表意思。正确了解各符号所代表的意思，可以帮助您更有把握更安全地操作本机器。

符号	含义
	GSB 10,8- 2-Li: 充电式冲击电钻起子机 打上灰色记号的部位：手柄（绝缘的握持位置）
	物品代码 X XXX XXXX XXX
	阅读所有的安全规章和说明
	在电动工具上进行任何维修的工作之前，都必须先取出蓄电池
	请佩戴耳罩
	移动方向
	反应方向
	正 / 逆转功能
	螺丝
	正常钻无震动功能
	冲击钻
	低转速
	高转速
	开动
	关闭

## 10 | 中文

符号	含义
	蓄电池的电量指示灯
U	额定电压
$n_0$ 1	空转转速 (1 档)
$n_0$ 2	空转转速 (2 档)
$n_s$	冲击次数
M	根据 ISO 5393 的最大扭力
	泥墙
	金属
	木材
$\varnothing$	最大钻孔直径
$\varnothing$ 	最大螺丝直径
	夹头的夹紧范围
	重量符合 EPTA-Procedure 01:2014
*	视所使用的蓄电池而定

## 供货范围

充电式冲击电钻起子机。  
蓄电池，安装工具和其它在图表或说明上提到的附件，并不包含在基本的供货范围中。

在本公司的附件清单中标列了完整的附件。

## 按照规定使用机器

本电动工具适用于拧入和拧出螺丝。本电动工具也可以在木材、金属、陶器和塑料上钻孔，或者在砖块、混凝土与石材上进行冲击钻。

## 技术数据

本产品的技术数据列在本使用说明书 33 页的表格中。请认清电动工具铭牌上的物品代码。电动工具在销售市场上没有统一的商品名称。

## 安装和操作

执行目的	图片	页数
取出蓄电池	1	34
安装蓄电池	2	34
安装工具	3	34
改变转向	4	35
设定扭力	5	35
设定操作模式	6	36
机械式选档	7	36
开动 / 关闭	8	37
检查蓄电池的充电状况	9	37
选择附件	-	38

## 维修和清洁

- ▶ 电动工具和通风间隙都必须保持清洁，这样才能提高工作品质 and 安全性。

## 顾客服务处和顾客咨询中心

本公司顾客服务处负责回答有关本公司产品的修理，维护和备件的问题。以下的网页中有爆炸图和备件的资料：

[www.bosch-pt.com](http://www.bosch-pt.com)

博世顾客咨询团队非常乐意为您解答

有关本公司产品及附件的问题。

询问和订购备件时，务必提供机器铭牌上标示的 10 位数物品代码。

有关保证，维修或更换零件事宜，请向合格的经销商查询。

## 中国大陆

博世电动工具（中国）有限公司

中国 浙江省 杭州市

滨江区滨康路 567 号

邮政编码：310052

免费服务热线：4008268484

传真：(0571) 87774502

电邮：[contact.ptcn@cn.bosch.com](mailto:contact.ptcn@cn.bosch.com)

[www.bosch-pt.com.cn](http://www.bosch-pt.com.cn)

罗伯特·博世有限公司

香港北角英皇道 625 号 21 楼

客户服务热线：+852 2101 0235

传真：+852 2590 9762

电邮：[info@hk.bosch.com](mailto:info@hk.bosch.com)

网站：[www.bosch-pt.com.hk](http://www.bosch-pt.com.hk)

**制造商地址：**

Robert Bosch Power Tools GmbH  
 罗伯特·博世电动工具有限公司  
 70538 Stuttgart / GERMANY  
 70538 斯图加特 / 德国

**搬运**

随着机器一起供货的锂离子蓄电池必须受危险物品法规规范。使用者无须另外使用保护包装便可以运送该蓄电池。

但是如果将它交由第三者运送（例如：寄空运或委托运输公司）则使用特殊的包装和标示。此时必须向危险物品专家请教有关寄送危险物品的相关事宜。

确定蓄电池的外壳未受损后，才可以寄送蓄电池。粘好未加盖的触点并包装好蓄电池，不可以让蓄电池在包装中晃动。

必要时也得注意各国有关的法规。

**处理废弃物**

必须以符合环保的方式，回收再利用损坏的电动工具，蓄电池，附件和废弃的包装材料。

不可以把电动工具和蓄电池 / 电池丢入一般的家庭垃圾中！

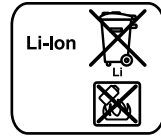
**充电电池 / 电池：**

**锂离子：**  
 请注意“搬运”段落中的指示，页 11。

保留修改权。

**中文****電動工具通用安全警告**

**警告** 閱讀所有警告和所有說明。不遵照以下警告和說明會導致電擊、著火和 / 或嚴重傷害。

保存所有警告和說明書以備查閱。

在所有下列的警告中術語“電動工具”指市電驅動（有線）電動工具或電池驅動（無線）電動工具。

**工作場地的安全**

- ▶ 保持工作場地清潔和明亮。混亂和黑暗的場地會引發事故。
- ▶ 不要在易爆環境，如有易燃液體、氣體或粉塵的環境下操作電動工具。電動工具產生的火花會點燃粉塵或氣體。

- ▶ 讓兒童和旁觀者離開後操作電動工具。注意力不集中會使你失去對工具的控制。

**電氣安全**

- ▶ 電動工具插頭必須與插座相配。絕不能以任何方式改裝插頭。需接地的電動工具不能使用任何轉換插頭。未經改裝的插頭和相配的插座將減少電擊危險。
- ▶ 避免人體接觸接地表面，如管道、散熱片和冰箱。如果你身體接地會增加電擊危險。
- ▶ 不得將電動工具暴露在雨中或潮濕環境中。水進入電動工具將增加電擊危險。
- ▶ 不得濫用電線。絕不能用電線搬運、拉動電動工具或拔出其插頭。使電線遠離熱源、油、銳邊或運動部件。受損或纏繞的軟線會增加電擊危險。
- ▶ 當在戶外使用電動工具時，使用適合戶外使用的外接軟線。適合戶外使用的軟線，將減少電擊危險。
- ▶ 如果在潮濕環境下操作電動工具是不可避免的，應使用剩餘電流動作保護器（RCD）。使用 RCD 可減小電擊危險。

**人身安全**

- ▶ 保持警覺，當操作電動工具時關注所從事的操作並保持清醒。當你感到疲倦，或在有藥物、酒精或治療反應時，不要操作電動工具。在操作電動工具時時間的疏忽會導致嚴重人身傷害。
- ▶ 使用個人防護裝置。始終佩戴護目鏡。安全裝置，諸如適當條件下使用防塵面具、防滑安全鞋、安全帽、聽力防護等裝置能減少人身傷害。
- ▶ 防止意外起動。確保開關在連接電源和 / 或電池盒、拿起或搬運工具時處於關斷位置。手指放在已接通電源的開關上或開關處於接通時插入插頭可能會導致危險。
- ▶ 在電動工具接通之前，拿掉所有調節鑰匙或扳手。遺留在電動工具旋轉零件上的扳手或鑰匙會導致人身傷害。
- ▶ 手不要伸展得太長。時刻注意立足點和身體平衡。這樣在意外情況下能很好地控制電動工具。
- ▶ 著裝適當。不要穿寬鬆衣服或佩戴飾品。讓你的衣服、手套和頭髮遠離運動部件。寬鬆衣服、佩飾或長髮可能會捲入運動部件中。
- ▶ 如果提供了與排屑、集塵設備連接用的裝置，要確保他們連接完好且使用得當。使用這些裝置可減少塵屑引起的危險。

**電動工具使用和注意事項**

- ▶ 不要濫用電動工具，根據用途使用適當的電動工具。選用適當設計的電動工具會使你工作更有效、更安全。
- ▶ 如果開關不能接通或關斷工具電源，則不能使用該電動工具。不能用開關來控制的電動工具是危險的且必須進行修理。

## 12 | 中文

- ▶ 在進行任何調節、更換附件或貯存電動工具之前，必須從電源上拔掉插頭和 / 或使電池盒與工具脫開。這種防護性措施將減少工具意外起動的危險。
- ▶ 將閒置不用的電動工具貯存在兒童所及範圍之外，並且不要讓不熟悉電動工具或對這些說明不瞭解的人操作電動工具。電動工具在未經培訓的用戶手中是危險的。
- ▶ 保養電動工具。檢查運動件是否調整到位或卡住，檢查零件破損情況和影響電動工具運行的其他狀況。如有損壞，電動工具應在使用前修理好。許多事故由維護不良的電動工具引發。
- ▶ 保持切削刀具鋒利和清潔。保養良好的有鋒利切削刃的刀具不易卡住而且容易控制。
- ▶ 按照使用說明書，考慮作業條件和進行的作業來使用電動工具、附件和工具的刀頭等。將電動工具用於那些與其用途不符的操作可能會導致危險。
- ▶ 如果安裝在機器上的工具被夾住了，必須馬上關閉電動工具並保持鎖靜。此時機器會產生極高的反應力矩，並進而造成回擊。安裝在機器上的工具容易被夾住如果：
  - 電動工具超荷了，或者
  - 安裝在機器上的工具在工件中歪斜了。
- ▶ 務必握緊電動工具。在擰緊和放鬆螺絲時，可能出現短暫的強大反擊。
- ▶ 固定好工件。使用固定裝置或老虎鉗固定工件，會比用手持握工件更牢固。
- ▶ 等待電動工具完全靜止後才能夠放下機器。機器上的工具可能在工作中被夾住，而令您無法控制電動工具。
- ▶ 切勿打開蓄電池。可能造成短路。



保護蓄電池免受高溫（例如長期日照），火焰，水和濕氣的侵害。有爆炸的危險。



- ▶ 如果蓄電池損壞了，或者未按照規定使用蓄電池，蓄電池中會散發出有毒蒸汽。工作場所必須保持空氣流通，如果身體有任何不適必須馬上就醫。蓄電池散發的蒸汽會刺激呼吸道。
- ▶ 本蓄電池只能配合博世的電動工具一起使用。這樣才能確保蓄電池不會過載。
- ▶ 只能使用博世原廠的蓄電池。電池的電壓必須和電動工具銘牌上規定的電壓相符。使用其他的蓄電池，例如仿制品，經過改造或其它品牌的蓄電池，有受傷的危險以及因為蓄電池爆炸而造成的財物損失。

## 電池式工具使用和注意事項

- ▶ 只用製造商規定的充電器充電。將適用於某種電池盒的充電器用到其他電池盒時會發生著火危險。
- ▶ 只有在配有專用電池盒的情況下才使用電動工具。使用其他電池盒會發生損壞和著火危險。
- ▶ 當電池盒不用時，將它遠離其他金屬物體，例如回形針、硬幣、鑰匙、釘子、螺釘或其他小金屬物體，以防一端與另一端連接。電池端部短路會引起燃燒或火災。
- ▶ 在濫用條件下，液體會從電池中濺出，避免接觸。如果意外碰到了，用水沖洗。如果液體碰到了眼睛，還要尋求醫療幫助。從電池中濺出的液體會發生腐蝕或燃燒。

## 檢修

- ▶ 將你的電動工具送交專業維修人員，必須使用同樣的備件進行更換。這樣將確保所維修的電動工具的安全性。

## 針對電鑽和電動扳手的 safety 規章

- ▶ 使用衝擊電鑽時要戴好耳罩。暴露在噪聲中會引起聽力損傷。
- ▶ 如果電動工具提供了輔助手柄便要使用它。操作時失控可能導致傷害。
- ▶ 安裝在機器上的工具或螺絲如果可能割斷隱藏的電線，一定要按住絕緣手柄操作電動工具。電動工具如果割斷了帶電的電線，機器上的金屬部件會導電，並進而導致操作者觸電。
- ▶ 使用合適的偵測器，以便找出隱藏著的電源線的位置。或者向當地的供電單位索取相關資料。鑽穿電線會造成火災並遭受電擊。損壞瓦斯管會引起爆炸。如果水管被刺穿了會導致財物損失。

## 進一步的安全規章和工作指示

- ▶ 含鉛的顏料以及某些木材、礦物和金屬的加工廢塵有害健康、可能造成過敏、讓操作者感染 呼吸道疾病和 / 或癌症。只有經過專業訓練的人員才能夠加工含石棉的物料。
  - 工作場所要保持空氣流通。
  - 最好佩戴 P2 濾網等級的口罩。
 請留心並遵守貴國和加工物料有關的法規。
- ▶ 避免讓工作場所堆積過多的塵垢。塵埃容易被點燃。
- ▶ 維修電動工具、更換電動工具上的工具或者搬運電動工具時，務必把正逆轉開關調整到中央的位置。如果不小心啟動起停開關，可能造成傷害。
- ▶ 交貨時蓄電池只完成部分充電，為了確保能夠發揮電池的最大功率，首度使用前必須把蓄電池放入充電器中充足電。
- ▶ 閱讀充電器的使用說明書。
- ▶ 確定電動工具已經關閉了，才可以把電動工具頂在螺絲頭上。轉動中的起子頭容易從螺絲頭上滑開。
- ▶ 待電動工具完全靜止後才能夠啟動選檔開關。
- ▶ 如果無法把選檔開關推到盡頭，可以稍微轉動夾頭。

- ▶ 在半按下或完全按下起停開關時，由 3 個綠色 LED 燈組成的蓄電池電量顯示裝置會以數秒鐘的時間顯示目前的蓄電池電量。

LED	容量
3 個綠燈持續亮著	$\geq 2/3$
2 個綠燈持續亮著	$\geq 1/3$
1 個綠燈持續亮著	$< 1/3$
1 個綠燈閃爍	備用電量

## 代表符號

以下的符號可以幫助您正確地使用本機器。請詳細閱讀各符號及它們的代表意思。正確了解各符號所代表的意義，可以幫助您更有把握更安全地操作本機器。

符號	含義
	GSB 10, 8-2-LI: 充電式衝擊電鑽起子機 打上灰色記號的部位：手柄（絕緣的握持位置）
	物品代碼 X XXX XXX XXX
	閱讀所有的安全規章和說明
	在電動工具上進行任何維修的工作之前，都必須先取出蓄電池
	請佩戴耳罩
	移動方向
	反應方向
	正 / 逆轉功能
	螺絲
	正常鑽無震動功能
	衝擊鑽

符號	含義
	低轉速
	高轉速
	開動
	關閉
	蓄電池的電量指示燈
U	額定電壓
$n_0$ 1	空轉轉速 (1 檔)
$n_0$ 2	空轉轉速 (2 檔)
$n_s$	衝擊次數
M	根據 ISO 5393 的最大扭力
	磚牆
	金屬
	木材
$\emptyset$	最大鑽孔直徑
$\emptyset$ 	最大螺絲直徑
	夾頭的夾緊範圍
	重量符合 EPTA-Procedure 01:2014
*	視所使用的蓄電池而定

## 供貨範圍

充電式衝擊電鑽起子機。  
蓄電池，安裝工具和其它在圖表或說明上提到的附件，並不包含在基本的供貨範圍中。  
在本公司的附件清單中標列了完整的附件。

## 按照規定使用機器

本電動工具適用於擰入和擰出螺絲。本電動工具也可以在木材、金屬、陶器和塑料上鑽孔，或者在磚塊、混凝土與石材上進行衝擊鑽。

## 技術性數據

本產品的技術數據列在本使用說明書 33 頁的表格中。請認清電動工具銘牌上的物品代碼。電動工具在銷售市場上沒有統一的商品名稱。

## 14 | 한국어

## 安裝和操作

執行目的	圖片	頁數
取出蓄電池	1	34
安裝蓄電池	2	34
安裝工具	3	34
改變轉向	4	35
設定扭力	5	35
設定操作模式	6	36
機械式選檔	7	36
開動 / 關閉	8	37
檢查蓄電池的充電狀況	9	37
選擇附件	-	38

## 維修和清潔

- ▶ **電動工具和通風間隙都必須保持清潔，這樣才能夠提高工作品質和安全性。**

## 顧客服務處和顧客諮詢中心

本公司顧客服務處負責回答有關本公司產品的修理、維護和備件的問題。以下的網頁中有爆炸圖和備件的資料：

[www.bosch-pt.com](http://www.bosch-pt.com)

博世顧客諮詢團隊非常樂意為您解答有關本公司產品及附件的問題。

詢問和訂購備件時，務必提供機器銘牌上標示的 10 位數物品代碼。

### 台灣

台灣羅伯特博世股份有限公司  
建國北路一段 90 號 6 樓  
台北市 10491  
電話：(02) 2515 5388  
傳真：(02) 2516 1176  
[www.bosch-pt.com.tw](http://www.bosch-pt.com.tw)

### 製造商地址：

Robert Bosch Power Tools GmbH  
羅伯特·博世電動工具有限公司  
70538 Stuttgart / GERMANY  
70538 斯圖加特 / 德國

## 搬運

隨著機器一起供貨的鋰離子蓄電池必須受危險物品法規範。使用者無須另外使用保護包裝便可以運送該蓄電池。但是如果將它交由第三者運送（例如：寄空運或委託運輸公司）則要使用特殊的包裝和標示。此時必須向危險物品專家請教有關寄送危險物品的相關事宜。

確定蓄電池的外殼未受損後，才可以寄送蓄電池。粘好未加蓋的觸點並包裝好蓄電池，不可以讓蓄電池在包裝中晃動。

必要時也得注意各國有關的法規。

## 處理廢棄物

 必須以符合環保的方式，回收再利用損壞的電動工具、蓄電池、附件和廢棄的包裝材料。

不可以把電動工具和蓄電池 / 電池丟入一般的家庭垃圾中！

**蓄電池 / 一般電池：**



**鋰離子：**  
請注意 "搬運" 段落中的指示，頁 14。

保留修改權。

## 한국어

### 전동공구용 일반 안전수칙

**경고** 모든 안전수칙과 지시 사항을 상세히 읽고 지켜야 합니다. 다음의 안전수칙과 지시 사항을 준수하지 않으면 화재 위험이 있으며 감전 혹은 중상을 입을 수 있습니다.

앞으로의 참고를 위해 이 안전수칙과 사용 설명서를 잘 보관하십시오.

다음에서 사용되는 "전동공구" 라는 개념은 전원에 연결하여 사용하는 전동 기기 (전선이 있는) 나 배터리를 사용하는 전동 기기 (전선이 없는) 를 의미합니다.

### 작업장 안전

▶ **작업장을 항상 깨끗이 하고 조명을 밝게 하십시오.**  
작업장 환경이 어수선하거나 어두우면 사고를 초래할 수 있습니다.

▶ **가연성 유체, 가스 또는 분진이 있어 폭발 위험이 있는 환경에서 전동공구를 사용하지 마십시오.** 전동공구는

분진이나 증기에 점화하는 스파크를 일으킬 수 있습니다.

- ▶ **전동공구를 사용할 때 구경꾼이나 어린이 혹은 다른 사람이 작업장에 접근하지 못하게 하십시오.** 다른 사람이 주의를 산만하게 하면 기기에 대한 통제를 잃기 쉽습니다.

#### 전기에 관한 안전

- ▶ **전동공구의 전원 플러그가 전원 콘센트에 잘 맞아야 합니다.** 플러그를 조금이라도 변경시켜서는 안됩니다. 접지된 전동공구를 사용할 때 어댑터 플러그를 사용하지 마십시오. 변형되지 않은 플러그와 잘 맞는 콘센트를 사용하면 감전의 위험을 감소할 수 있습니다.
- ▶ **파이프 관, 라디에이터, 레인지, 냉장고와 같은 접지 표면에 물이 닿지 않도록 하십시오.** 몸에 닿을 경우 감전될 위험이 높습니다.
- ▶ **전동공구를 비에 맞지 않게 하고 습기 있는 곳에 두지 마십시오.** 전동공구에 물이 들어가면 감전될 위험이 높습니다.
- ▶ **전원 코드를 잡고 전동공구를 운반하거나 걸어 놓아서는 안되며, 콘센트에서 전원 플러그를 뽑을 때 전원 코드를 잡아 당겨서는 절대로 안됩니다.** 전원 코드가 열과 오일에 접촉하는 것을 피하고, 날카로운 모서리나 기기의 가동 부위에 닿지 않도록 주의하십시오. 손상되거나 영긴 전원 코드는 감전을 유발할 수 있습니다.
- ▶ **실외에서 전동공구로 작업할 때는 실외용으로 적당한 연장 전원 코드만을 사용하십시오.** 실외용 연장 전원 코드를 사용하면 감전의 위험을 줄일 수 있습니다.
- ▶ **전동공구를 습기 찬 곳에서 사용해야 할 경우에는 누전 차단기를 사용하십시오.** 누전 차단기를 사용하면 감전 위험을 줄일 수 있습니다.

#### 사용자 안전

- ▶ **신중하게 작업하십시오.** 작업을 할 때 주의를 하며, 전동공구를 사용할 때 경솔하게 행동하지 마십시오. 피로한 상태이거나 약물 복용 및 음주한 후에는 전동공구를 사용하지 마십시오. 전동공구를 사용할 때 잠시라도 주위가 산만해지면 중상을 입을 수 있습니다.
- ▶ **작업자 안전을 위한 장치를 사용하십시오.** 항상 보안경을 착용하십시오. 전동공구의 종류와 사용에 따라 먼지 보호 마스크, 미끄러지지 않는 안전한 신발, 안전모 또는 귀마개 등의 안전한 복장을 하면 상해의 위험을 줄일 수 있습니다.
- ▶ **실수로 기기가 작동되지 않도록 주의하십시오.** 전동공구를 전원에 연결하거나 배터리를 끼우기 전에, 혹은 기기를 들거나 운반하기 전에, 전원 스위치가 꺼져 있는지 다시 확인하십시오. 전동공구를 운반할 때 전원 스위치에 손가락을 대거나 전원 스위치가 켜진 상태에서 전원을 연결하면 사고 위험이 높습니다.
- ▶ **전동공구를 사용하기 전에 조절하는 톨이나 나사 키 등을 빼 놓으십시오.** 회전하는 부위에 있는 톨이나 나사 키로 인해 상처를 입을 수 있습니다.

- ▶ **자신을 과신하지 마십시오.** 불안정한 자세를 피하고 항상 평형을 이룬 상태로 작업하십시오. 안정된 자세와 평형한 상태로 작업해야만이 의외의 상황에서도 전동공구를 안전하게 사용할 수 있습니다.
- ▶ **알맞은 작업복을 입으십시오.** 헐렁한 복장을 하거나 장신구를 착용하지 마십시오. 머리카락 또는 장갑이 가동하는 기기 부위에 가까이 닿지 않도록 주의하십시오. 헐렁한 복장, 장신구 혹은 긴 머리는 가동 부위에 말려 사고를 초래할 수 있습니다.
- ▶ **분진 추출장치나 수거장치의 조립이 가능한 경우, 이 장치가 연결되어 있는지, 제대로 작동이 되는지 확인하십시오.** 이러한 분진 추출장치를 사용하면 분진으로 인한 사고 위험을 줄일 수 있습니다.

#### 전동공구의 올바른 사용과 취급

- ▶ **기기를 과부하 상태에서 사용하지 마십시오.** 작업할 때 이에 적당한 전동공구를 사용하십시오. 알맞은 전동공구를 사용하면 지정된 성능 한도 내에서 더 효율적으로 안전하게 작업할 수 있습니다.
- ▶ **전원 스위치가 고장 난 전동공구를 사용하지 마십시오.** 전원 스위치가 작동되지 않는 전동공구는 위험하므로, 반드시 수리를 해야 합니다.
- ▶ **기기에 세팅을 하거나 액세서리 부품을 교환하거나 혹은 기기를 보관할 때, 항상 전원 콘센트에서 플러그를 미리 빼어 놓으십시오.** 이러한 조치는 실수로 전동공구가 작동하게 되는 것을 예방합니다.
- ▶ **사용하지 않는 전동공구는 어린이 손이 닿지 않는 곳에 보관하고, 전동공구 사용에 익숙지 않거나 이 사용 설명서를 읽지 않은 사람은 기기를 사용해서는 안됩니다.** 경험이 없는 사람이 전동공구를 사용하면 위험합니다.
- ▶ **전동공구를 조심스럽게 관리하십시오.** 가동 부위가 하자 없이 정상적인 기능을 하는지, 걸리는 부위가 있는지, 혹은 전동공구의 기능에 중요한 부품이 손상되지 않았는지 확인하십시오. 손상된 기기의 부품은 전동공구를 다시 사용하기 전에 반드시 수리를 맡기십시오. 제대로 관리하지 않은 전동공구의 경우 많은 사고를 유발합니다.
- ▶ **절단 공구를 날카롭고 깨끗하게 관리하십시오.** 날카로운 절단면이 있고 잘 관리된 절단공구는 걸리는 경우가 드물고 조절하기도 쉽습니다.
- ▶ **전동공구, 액세서리, 장착하는 공구 등을 사용할 때, 이 지시 사항과 특별히 기종 별로 나와있는 사용 방법을 준수하십시오.** 이때 작업 조건과 실시하려는 작업 내용을 고려하십시오. 원래 사용 분야가 아닌 다른 작업에 전동공구를 사용할 경우 위험한 상황을 초래할 수 있습니다.

#### 충전 전동공구의 올바른 사용과 취급

- ▶ **배터리를 충전할 때 제조 회사가 추천하는 충전기만을 사용하여 재충전해야 합니다.** 특정 제품의 배터리를 위

16 | 한국어

하여 제조된 충전기에 적합하지 않은 다른 배터리를 충전할 경우 화재 위험이 있습니다.

- ▶ **각 전동공구용으로 나와있는 배터리만을 사용하십시오.** 다른 종류의 배터리를 사용하면 상해를 입거나 화재를 초래할 수 있습니다.
- ▶ **배터리를 사용하지 않을 때는, 각 극 사이에 브리징 상태가 생길 수 있으므로 페이퍼 클립, 동전, 열쇠, 못, 나사 등 유사한 금속성 물체와 멀리하여 보관하십시오.** 배터리 극 사이에 쇼트가 일어나 화상을 입거나 화재를 야기할 수 있습니다.
- ▶ **배터리를 잘못 사용하면 누수가 생길 수 있습니다.** 누수가 생긴 배터리에 닿지 않도록 하십시오. 피부에 접하게 되었을 경우 즉시 물로 씻으십시오. 유체가 눈에 닿았을 경우 바로 의사와 상담하십시오. 배터리에서 나오는 유체는 피부에 자극을 주거나 화상을 입힐 수 있습니다.

**서비스**

- ▶ **전동공구 수리는 반드시 전문 인력에게 맡기고, 수리 정비 시 보쉬 순정 부품만을 사용하십시오.** 그렇게 함으로써 기기의 안전성을 오래 유지할 수 있습니다.

**드릴 머신과 스크류 드라이버용 안전 수칙**

- ▶ **임팩트 드릴작업을 할 때 귀마개를 착용하십시오.** 소음으로 인해 청각을 상실할 수 있습니다.
- ▶ **보조 손잡이가 전동공구와 함께 공급되는 경우 이를 사용하십시오.** 통제를 잃게되면 상해를 입을 수 있습니다.
- ▶ **작업할 때 드릴 비트나 나사로 보이지 않는 전선에 닿을 가능성이 있으면 전동공구의 절연 손잡이면을 잡으십시오.** 전류가 흐르는 전선에 접하게 되면 전동공구의 금속 부위도 전기가 통해 감전이 될 수 있습니다.
- ▶ **보이지 않는 부위에 에너지 배선 및 배관여부를 확인하려면 적당한 탐지기를 사용하거나 담당 에너지 공급 회사에 문의하십시오.** 전선에 접촉하게 되면 화재나 전기 충격을 유발할 수 있습니다. 가스관을 손상시키면 폭발 위험이 있으며 수도관을 파손하게 되면 재산 피해를 야기할 수 있습니다.
- ▶ **틀 출더에 끼워진 비트가 물리면 즉시 전동공구 스위치를 끄십시오.** 반동을 유발할 수 있는 강한 반동력이 생길 수 있습니다. 틀 출더에 끼워진 비트는 다음의 경우 물립니다:
  - 전동공구가 과부하된 상태이거나
  - 작업하려는 소재에 걸렸을 경우 물립니다.
- ▶ **전동공구를 꼭 잡으십시오.** 나사못을 조이거나 풀 때 일시적으로 강한 반동력이 생길 수 있습니다.
- ▶ **작업물을 잘 고정하십시오.** 고정장치나 기계 바이스에 끼워서 작업하면 손으로 잡는 것보다 더 안전합니다.

- ▶ **전동공구를 내려놓기 전에 기기가 완전히 멈추었는지를 확인하십시오.** 벨트가 걸려 전동공구에 대한 통제가 어려워질 수 있습니다.

- ▶ **배터리를 분해하지 마십시오.** 단락이 발생할 위험이 있습니다.



배터리를 태양 광선 등 고열에 장시간 노출되지 않도록 하고 불과 물, 수분이 있는 곳에 두지 마십시오. 폭발할 위험이 있습니다.



- ▶ **배터리가 손상되었거나 잘못 사용될 경우 증기가 발생할 수 있습니다.** 작업장을 환기시키고, 필요한 경우 의사와 상담하십시오. 증기로 인해 호흡기가 자극될 수 있습니다.

- ▶ **배터리를 보쉬 전동공구와 함께 사용해야 합니다.** 그렇게 해야만 배터리를 위험한 과부하로부터 보호할 수 있습니다.

- ▶ **전동공구의 타입 표시판에 나와있는 전압에 해당하는 보쉬 순정 배터리만을 사용하십시오.** 모조품이나 재생 복원 배터리 혹은 타사의 배터리를 사용하면 폭발성이 있는 배터리로 인해 상해를 입을 수 있으며 물적 손해를 볼 수 있습니다.

**기타 안전수칙 및 사용방법**

- ▶ **납 성분을 함유한 페인트나 몇몇 목재 종류, 광물 및 금속 등 소재의 분진은 건강에 유해할 수 있으며 알레르기 반응이나 호흡기 질환 그리고 / 혹은 암을 유발할 수 있습니다.** 석면을 함유한 소재는 위험하므로 전문 인력들만이 작업해야 합니다.
  - 작업장의 통풍이 잘 되도록 하십시오.
  - 필터등급 P2가 장착된 호흡 마스크를 사용하십시오.

작업용 재료에 관해 국가가 지정한 규정을 고려 하십시오.

- ▶ **작업장에 분진이 쌓이지 않도록 하십시오.** 분진이 쉽게 발화할 수 있습니다.

- ▶ **전동공구에 정비를 하거나 비트 등을 교환하기 전에, 혹은 기기를 운반하거나 보관할 때 회전방향 선택 스위치를 반드시 중간 위치에 두십시오.** 실수로 전원 스위치가 작동하여 상해를 입을 수 있습니다.

- ▶ **배터리는 일부 충전된 상태로 공급됩니다.** 배터리의 완전한 성능을 보장하려면 처음 사용하기 전에 배터리를 완전히 충전해야 합니다.

- ▶ **충전기의 사용 설명서를 읽으십시오.**
- ▶ **전동공구의 스위치가 꺼진 상태에서만 나사못에 대십시오.** 회전하는 드릴 비트가 미끄러질 수 있습니다.
- ▶ **기어 선택 스위치는 전동공구가 정지된 상태에서만 작동하십시오.**
- ▶ **기어 선택 스위치가 끝까지 밀어지지 않으면 드릴 척을 약간 돌립니다.**



▶ 배터리 충전상태 표시기는 3 칸의 녹색 LED 로 구성되어 있으며, 전원 스위치를 몇 초 동안 반 정도 혹은 완전히 누른 상태에서 배터리의 충전상태를 보여줍니다.

LED	용량
연속등 3 x 녹색	≥ 2/3
연속등 2 x 녹색	≥ 1/3
연속등 1 x 녹색	< 1/3
깜박등 1 x 녹색	예비

### 기호

다음에 나와있는 기호는 사용 설명서를 읽고 이해하는데 중요합니다. 그러므로 기호와 그 의미를 잘 기억하십시오. 기호를 제대로 이해하면 전동공구를 더욱 쉽고 안전하게 사용할 수 있습니다.

기호	의미
----	----



GSB 10,8- 2-Li:  
충전 해머 드릴  
회색 표시 부위: 손잡이 (절연 손잡이)

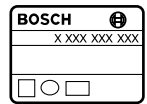

제품 번호



모든 안전 수칙과 지시 사항을 읽으십시오



전동공구에 각종 작업을 하기 전에 배터리를 빼어 놓으십시오



귀마개를 착용하십시오



이동 방향



반동 방향



역회전 기능



나사



타격 없는 드릴작업



임팩트 드릴작업

기호	의미
----	----



저속



고속



스위치 켜기



스위치 끄기



배터리 충전 표시기



정격 전압



무부하 속도 (1 단)



무부하 속도 (2 단)



타격률



ISO 5393 에 따른 최대 토크



벽돌



금속



목재



최대 드릴 직경



나사못 직경, 최대



드릴 척 클램핑 범위



EPTA 공정 01:2014 에 따른 중량



\* 사용하는 배터리에 따라 상이

### 공급 내역

충전 해머 드릴.

배터리, 각종 비트류 및 기타 도면이나 설명서에 나온 액세서리는 표준 공급부품에 속하지 않습니다.

전체 액세서리는 본사 액세서리 프로그램을 참고하십시오.

### 규정에 따른 사용

본 전동공구는 나사못을 조이거나 푸는 작업, 목재 금속 세라믹 플라스틱에 구멍을 내는 작업, 그리고 벽돌 콘크리트 석재에 임팩트 드릴작업을 하는 데 사용해야 합니다.

### 제품 사양

제품의 제품 사양은 본 사용 설명서의 33 면의 도표에 나와있습니다.

전동공구의 명판에 표시된 제품 번호를 확인하십시오. 각 전동공구의 명칭이 시중에서 상이하게 사용될 수 있습니다.

18 | ภาษาไทย

**조립 및 작동**

작업 내용	그림	면
배터리 탈착하기	1	34
배터리 장착하기	2	34
삽입공구 조립하기	3	34
회전방향 설정하기	4	35
토크 설정하기	5	35
작동 모드 설정하기	6	36
기계식 기어 선택	7	36
전원 스위치 작동하기	8	37
배터리 충전 상태 확인하기	9	37
액세서리 선택하기	-	38

**보수 정비 및 유지**

▶ 안전하고 올바른 작동을 위하여 전동공구와 전동공구의 통풍구를 항상 깨끗이 하십시오 .

**보수 AS 및 고객 상담**

보수는 귀하의 제품 및 수리에 관한 문의를 받고 있습니다 .

AS 센터 정보 및 제품에 대한 고객 상담은 하기 고객 콜센터 및 이메일 상담을 이용해주시기 바랍니다 .

**고객 콜센터 : 080-955-0909**

**이메일 상담 :**

**Bosch-pt.hotline@kr.bosch.com**

문의 사항이 있거나 스페어 부품을 주문할 때 반드시 전동공구의 타입 표시판에 적힌 10 자리의 제품 번호를 알려 주십시오 .

**한국로버트보쉬 ( 주 )**

경기도 용인시 기흥구 보정동 298 번지

**www.bosch-pt.co.kr**

**운반**

포함되어 있는 리튬이온 배터리는 위험물 관련 규정을 따라야 합니다 . 사용자가 별도의 요구사항 없이 배터리를 직접 도로 상에서 운반할 수 있습니다 .

제3자를 통해 운반할 경우 ( 항공 운송이나 운송 회사 등 ) 포장과 표기에 관한 특별한 요구 사항을 준수해야 합니다 . 이 경우 발송 준비를 위해 위험물 전문가와 상담해야 합니다 .

표면이 손상되지 않은 배터리만을 사용하십시오 . 배터리의 접촉 단자면을 덮어 붙인 상태로 내부에서 움직이지 않도록 배터리를 포장하십시오 .

또한 이와 관련한 국내 규정을 준수하십시오 .

**처리**

 전동공구, 배터리, 액세서리 및 포장은 친환경적인 방법으로 재활용할 수 있도록 분류하십시오 .

전동공구와 충전용 배터리 / 배터리를 가정용 쓰레기로 처리하지 마십시오 !

**충전용 배터리 / 배터리 :**



**Li-Ion:**

“운반” 내용에 나와 있는 주의 사항을 준수하십시오 , 18 면 .

위 사항은 사전 예고 없이 변경될 수도 있습니다 .

**ภาษาไทย**

**คำเตือนทั่วไปเพื่อความปลอดภัยในการใช้เครื่องมือไฟฟ้า**

**คำเตือน** ต้องอ่านคำเตือนเพื่อความปลอดภัยและคำสั่งทั้งหมด การไม่ปฏิบัติตามคำเตือนและคำสั่งอาจเป็นสาเหตุให้ถูกไฟฟ้าดูด เกิดไฟไหม้ และ/หรือได้รับบาดเจ็บอย่างร้ายแรง

**เก็บรักษาคำเตือนและคำสั่งทั้งหมดสำหรับเปิดอ่านในภายหลัง**

คำว่า "เครื่องมือไฟฟ้า" ในคำเตือนหมายถึง เครื่องมือไฟฟ้าของท่านที่ทำงานด้วยพลังงานไฟฟ้าที่ต่อจากเต้าเสียบ (มีสายไฟฟ้า) และเครื่องมือไฟฟ้าที่ทำงานด้วยพลังงานไฟฟ้าจากแบตเตอรี่ (ไร้สาย)

**ความปลอดภัยในสถานที่ทำงาน**

▶ **รักษาสถานที่ทำงานให้สะอาดและมีไฟส่องสว่างดี** สถานที่ที่มีมืดหรือรกรุงรำนามซึ่งอุบัติเหตุ

▶ **อย่าใช้เครื่องมือไฟฟ้าในสภาพแวดล้อมที่เสี่ยงต่อการติดระเบิดได้** เช่น ในที่มีของเหลว แก๊ส หรือฝุ่นที่ติดไฟได้ เมื่อใช้เครื่องมือไฟฟ้าจะเกิดประกายไฟซึ่งอาจจุดฝุ่นหรือไอให้ลุกเป็นไฟได้

- ▶ **ขณะใช้เครื่องมือไฟฟ้าทำงาน ต้องกันเด็กและผู้ยืมดูให้ออกห่าง** การหันเหความสนใจอาจทำให้ท่านขาดการควบคุมเครื่องได้

#### ความปลอดภัยเกี่ยวกับไฟฟ้า

- ▶ **ปลั๊กของเครื่องมือไฟฟ้าต้องมีขนาดพอดีกับเต้าเสียบ** อย่าตัดแปลงหรือแก้ไขตัวปลั๊กอย่างเด็ดขาด อย่าต่อปลั๊กต่อใดๆ เข้ากับเครื่องมือไฟฟ้าที่มีสายดิน ปลั๊กที่ไม่ตัดแปลงและเต้าเสียบที่เข้ากันช่วยลดความเสี่ยงจากการถูกไฟฟ้าดูด
- ▶ **หลีกเลี่ยงไม่ให้ร่างกายสัมผัสกับพื้นผิวของสิ่งของที่ต่อสายดินไว้ เช่น ท่อ เครื่องทำความร้อน เต้า และตู้เย็น** จะเสี่ยงอันตรายจากการถูกไฟฟ้าดูดมากขึ้นหากกระแสไฟฟ้าวิ่งผ่านร่างกายของท่านลงดิน
- ▶ **อย่าวางเครื่องมือไฟฟ้าตากฝนหรือทิ้งไว้ในที่ชื้นแฉะ** หากน้ำเข้าในเครื่องมือไฟฟ้า จะเพิ่มความเสี่ยงจากการถูกไฟฟ้าดูด
- ▶ **อย่าใช้สายไฟอย่างผิดๆ อย่าถือเครื่องมือไฟฟ้าที่สาย** อย่าใช้สายแขวนเครื่อง หรืออย่าดึงสายไฟฟ้าเพื่อถอดปลั๊กออกจากเต้าเสียบ กันสายไฟฟ้าออกห่างจากความร้อน น้ำมัน ขอบแหลมคม หรือส่วนของเครื่องที่กำลังเคลื่อนไหว สายไฟฟ้าที่ชำรุดหรือพันกันยุ่งเพิ่มความเสี่ยงจากการถูกไฟฟ้าดูด
- ▶ **เมื่อใช้เครื่องมือไฟฟ้าทำงานกลางแจ้ง ให้ใช้สายไฟต่อที่ได้รับการรับรองให้ใช้ต่อในที่กลางแจ้งเท่านั้น** การใช้สายไฟต่อที่เหมาะสมสำหรับงานกลางแจ้งช่วยลดอันตรายจากการถูกไฟฟ้าดูด
- ▶ **หากไม่สามารถหลีกเลี่ยงการใช้เครื่องมือไฟฟ้าทำงานในสถานที่เปียกชื้นได้ ให้ใช้วิธีหัดดวงจรเมื่อเกิดการรั่วไหลของไฟฟ้าจากสายดิน** การใช้วิธีหัดดวงจรเมื่อเกิดการรั่วไหลของไฟฟ้าจากสายดินช่วยลดความเสี่ยงต่อการถูกไฟฟ้าดูด

#### ความปลอดภัยของบุคคล

- ▶ **ท่านต้องอยู่ในสภาพเตรียมพร้อม ระมัดระวังในสิ่งที่กำลังทำอยู่ และมีสติขณะใช้เครื่องมือไฟฟ้าทำงาน** อย่าใช้เครื่องมือไฟฟ้าขณะที่ท่านกำลังเหนื่อย หรืออยู่ภายใต้การครอบงำของฤทธิ์ของยาเสพติด แอลกอฮอล์ และยา เมื่อใช้เครื่องมือไฟฟ้าทำงาน ในชั่วนาทีที่ท่านขาดความเอาใจใส่อาจทำให้บุคคลบาดเจ็บอย่างรุนแรงได้
- ▶ **ใช้อุปกรณ์ปกป้องร่างกาย สวมแว่นตาป้องกันเสมอ** อุปกรณ์ปกป้อง เช่น หน้ากากกันฝุ่น รองเท้ากันลื่น หมวกแข็ง หรือประคบหูกันเสียงดัง ที่เลือกใช้ตามความเหมาะสมกับสภาพการทำงาน สามารถลดอันตรายต่อบุคคลได้

- ▶ **ป้องกันการติดเครื่องโดยไม่ตั้งใจ ต้องดูให้แน่ใจว่าสวิทช์อยู่ในตำแหน่งปิดก่อนเสียบปลั๊กไฟเข้าในเต้าเสียบ และ/หรือใส่แท่งเบรคเตอร์ ยักษ์ขึ้นหรือถือเครื่องมือ** การถือเครื่องโดยใช้นิ้วหัวที่สวิทช์ หรือเสียบปลั๊กไฟขณะสวิทช์เปิดอยู่ อาจนำไปสู่อุบัติเหตุที่ร้ายแรงได้
- ▶ **เอาเครื่องมือปรับแต่งหรือประแจปากตายออกจากเครื่องมือไฟฟ้าก่อนเปิดสวิทช์** เครื่องมือหรือประแจปากตายที่วางอยู่กับส่วนของเครื่องที่กำลังหมุนจะทำให้บุคคลบาดเจ็บได้
- ▶ **หลีกเลี่ยงการตั้งท่าที่ผิดปกติ ตั้งทำยืนที่มั่นคงและวางน้ำหนักให้สมดุลตลอดเวลา** ในลักษณะนี้ท่านสามารถควบคุมเครื่องมือไฟฟ้าในสถานการณ์ที่ไม่คาดคิดได้ดีกว่า
- ▶ **ใส่เสื้อผ้าที่เหมาะสม** อย่าใส่เสื้อผ้าหลวมหรือสวมเครื่องประดับ เอาผม เลือ่ผ้า และถุงมือออกห่างส่วนของเครื่องที่กำลังหมุน เลือ่ผ้าหลวม เครื่องประดับ และผมยาวอาจเข้าไปติดในส่วนของเครื่องที่กำลังหมุนได้
- ▶ **หากต้องต่อเครื่องมือไฟฟ้าเข้ากับเครื่องดูดฝุ่นหรือเครื่องเก็บผง** ดูให้แน่ใจว่าการเชื่อมต่อและการใช้งานเป็นไปอย่างถูกต้อง การใช้อุปกรณ์ดูดฝุ่นช่วยลดอันตรายที่เกิดจากฝุ่นได้

#### การใช้และการดูแลรักษาเครื่องมือไฟฟ้า

- ▶ **อย่าใช้เครื่องมือไฟฟ้าอย่างหักโหม ใช้เครื่องมือไฟฟ้าที่ถูกต้องตรงตามลักษณะงาน** เครื่องมือไฟฟ้าที่ถูกต้องจะทำงานได้ดีกว่าและปลอดภัยกว่าในระดับสมรรถภาพที่ออกแบบไว้
- ▶ **อย่าใช้เครื่องมือไฟฟ้าที่สวิทช์เปิดปิดเสีย** เครื่องมือไฟฟ้าที่ไม่สามารถควบคุมการเปิดปิดด้วยสวิทช์ได้ เป็นเครื่องมือไฟฟ้าที่ไม่ปลอดภัยและต้องส่งซ่อมแซม
- ▶ **ก่อนปรับแต่งเครื่อง เปลี่ยนอุปกรณ์ประกอบ หรือเก็บเครื่องเข้าที่** ต้องถอดปลั๊กไฟออกจากเต้าเสียบ และ/หรือถอดแท่งเบรคเตอร์ออกจากเครื่องมือไฟฟ้า มาตรการป้องกันเพื่อความปลอดภัยนี้ช่วยลดความเสี่ยงจากการติดเครื่องโดยไม่ตั้งใจ
- ▶ **เมื่อเลิกใช้งานเครื่องมือไฟฟ้า ให้เก็บเครื่องไว้ในที่ที่เด็กหยิบไม่ถึง และไมอนุญาตให้บุคคลที่ไม่คุ้นเคยกับเครื่องหรือบุคคลที่ไม่ได้อ่านคำแนะนำนี้ใช้เครื่องมือไฟฟ้า** เป็นของอันตรายหากตกอยู่ในมือของผู้ใช้ที่ไม่ได้รับการฝึกฝน
- ▶ **เอาใจใส่ดูแลรักษาเครื่อง** ตรวจสอบหาส่วนที่เคลื่อนไหวได้ของเครื่องว่าวางอยู่ตรงแนวหรือติดขัดหรือไม่ ตรวจสอบการแตกหักของชิ้นส่วนและสภาพอื่นใดที่อาจมีผลต่อการทำงานของเครื่องมือไฟฟ้า หากชำรุด

## 20 | ภาษาไทย

ต้องส่งเครื่องมือไฟฟ้าซ่อมแซมก่อนใช้งาน อุบัติเหตุหลายอย่างเกิดขึ้นเนื่องจากดูแลรักษาเครื่องมือไม่ดีพอ

- ▶ **รักษาเครื่องมือตัดให้คมและสะอาด** หากบำรุงรักษาเครื่องมือที่มีขอบตัดแหลมคมอย่างถูกต้อง จะสามารถตัดได้ลื่นไม่ติดขัดและความคมได้ง่ายกว่า
- ▶ **ใช้เครื่องมือไฟฟ้า อุปกรณ์ประกอบ เครื่องมือ และอุปกรณ์อื่นๆ** ให้ตรงตามคำแนะนำนี้ และในลักษณะตามที่เครื่องมือไฟฟ้าประเภทนั้นๆ กำหนดไว้ โดยต้องคำนึงถึงเงื่อนไขการทำงานและงานที่จะทำด้วย การใช้เครื่องมือไฟฟ้าทำงานที่ต่างไปจากวัตถุประสงค์การใช้งานของเครื่อง อาจนำไปสู่สถานการณ์ที่เป็นอันตรายได้

#### การใช้และการดูแลรักษาเครื่องที่ใช้แบตเตอรี่

- ▶ **ชาร์จแบตเตอรี่ด้วยเครื่องชาร์จที่บริษัทผู้ผลิตระบุไว้เท่านั้น** เครื่องชาร์จที่เหมาะสมสำหรับชาร์จแบตเตอรี่ประเภทหนึ่ง หากนำไปชาร์จแบตเตอรี่ประเภทอื่น อาจเกิดไฟไหม้ได้
- ▶ **ใช้แบตเตอรี่เฉพาะประเภทที่เครื่องมือไฟฟ้ากำหนดให้ใช้ได้** การใช้แบตเตอรี่ประเภทอื่นเสี่ยงต่อการเกิดไฟไหม้หรือบาดเจ็บ
- ▶ **เมื่อไม่ใช้แบตเตอรี่ ให้เก็บแบตเตอรี่ไว้ห่างโลหะวัตถุอื่นๆ เช่น คลิปหนีบกระดาษ เหรียญ คุกกี้ ตะปู สกรู หรือโลหะวัตถุขนาดเล็กอื่นๆ ที่สามารถต่อขั้วหนึ่งไปยังอีกขั้วหนึ่งได้** การลัดวงจรของขั้วแบตเตอรี่อาจทำให้เกิดการไหม้หรือไฟลุกได้
- ▶ **เมื่อใช้แบตเตอรี่ผิดวิธี อาจมีของเหลวไหลออกมาจากแบตเตอรี่ได้** ให้หลีกเลี่ยงการสัมผัสของเหลว หากสัมผัสโดยบังเอิญ ให้ใช้น้ำล้าง หากของเหลวเข้าตาให้ขอความช่วยเหลือจากแพทย์ด้วย ของเหลวที่ไหลออกมาจากแบตเตอรี่อาจทำให้เกิดอาการคันหรือแสบผิวหนังได้

#### การบริการ

- ▶ **ส่งเครื่องมือไฟฟ้าให้ช่างผู้เชี่ยวชาญตรวจสอบและใช้อะไหล่เปลี่ยนของแท้เท่านั้น** ในลักษณะนี้ท่านจะแน่ใจได้ว่าเครื่องมือไฟฟ้าอยู่ในสภาพที่ปลอดภัย

#### คำแนะนำเพื่อความปลอดภัยสำหรับส่วนและไขควง

- ▶ **สวมอุปกรณ์ป้องกันเมื่อเจาะกระแทก** การได้รับเสียงดังอาจทำให้สูญเสียการได้ยิน
- ▶ **หากด้ามจับเพิ่มจัดส่งมาพร้อมกับเครื่อง ให้ใช้ด้ามจับเพิ่มร่วมด้วย** การสูญเสียการควบคุมอาจทำให้บุคคลบาดเจ็บได้

▶ **เมื่อทำงานในบริเวณที่เครื่องมือตัดหรือสกรูอาจสัมผัสกับสายไฟฟ้าที่ซ่อนอยู่** ต้องจับเครื่องมือไฟฟ้าตรงด้ามจับที่หุ้มฉนวน เครื่องมือตัดและสกรูที่สัมผัสกับสายที่ "มีกระแสไฟฟ้า" ไหลอยู่อาจทำให้ส่วนที่เป็นโลหะของเครื่องมือไฟฟ้าเกิด "มีกระแสไฟฟ้า" ด้วย และสามารถส่งผลให้ผู้ใช้เครื่องถูกไฟฟ้าดูดได้

▶ **ใช้เครื่องตรวจที่เหมาะสมตรวจหาท่อและสายไฟฟ้าที่อาจซ่อนอยู่ในบริเวณที่จะทำงาน** หรือขอความช่วยเหลือจากบริษัททางท่อและสายไฟฟ้าในท้องถิ่น การสัมผัสกับสาย ไฟฟ้าอาจทำให้เกิดไฟไหม้หรือถูกไฟฟ้าช็อกหรือดูดได้ การ ทำให้ท่อแก๊สเสียหายอาจเกิดระเบิดได้ การเจาะเข้าในท่อน้ำ ทำให้ทรัพย์สินเสียหาย

▶ **ปิดเครื่องมือไฟฟ้าทันทีที่เครื่องมือที่ใส่อยู่เกิดติดขัดเตรียมตัวรับแรงบิดสะท้อนสูงที่ทำให้เกิดการตีกลับ** เครื่องมือที่ใส่อยู่ติดขัดเนื่องจาก:  
– เครื่องมือไฟฟ้าถูกใช้งานเกินกำลังปกติ หรือ  
– เครื่องมือทิ่มเยื้องอยู่ในชิ้นงาน

▶ **จับเครื่องมือไฟฟ้าให้แน่น** ขณะขันสกรูเข้าและคลายออก อาจเกิดแรงบิดสะท้อนช่วงสั้นๆ อย่างรุนแรงได้

▶ **ยึดชิ้นงานให้แน่น** การยึดชิ้นงานด้วยเครื่องมือหนีบหรือแท่นจับจะมั่นคงกว่าการยึดด้วยมือ

▶ **ก่อนวางเครื่องลงบนพื้นทุกครั้งต้องรอให้เครื่องหยุดนิ่งอยู่กับที่เสมอ** มิฉะนั้นเครื่องมือที่ใส่อยู่อาจติดขัดและนำไปสู่การสูญเสียการควบคุมเครื่องมือไฟฟ้า

▶ **อย่าเปิดแบตเตอรี่ด้วยตนเอง** อันตรายจากการลัดวงจร



ปกป้องแบตเตอรี่จากความร้อน ต. ย. เช่น จากแสงแดดจ้าที่ส่องอย่างต่อเนื่อง ไฟ น้ำ และ ความชื้น อันตรายจากการระเบิด



▶ **ในกรณีที่แบตเตอรี่ชำรุดและใช้แบตเตอรี่อย่างไม่ถูกต้อง อาจมีไอระเหยออกมา** ให้สูดอากาศบริสุทธิ์และหาแพทย์ในกรณีเจ็บปวด ไอระเหยอาจทำให้ระบบหายใจระคายเคือง

▶ **ใช้แบตเตอรี่เฉพาะกับเครื่องมือไฟฟ้า บอช ของท่านเท่านั้น** การกระทำเช่นนี้เท่านั้นที่จะช่วยปกป้องแบตเตอรี่จากการถูกใช้งานเกินขีดซึ่งเป็นอันตราย

▶ **ใช้เฉพาะแบตเตอรี่ของแท้ของ บอช ที่มีแรงดันไฟฟ้าที่ระบุไว้บนแผ่นป้ายรุ่นของเครื่องมือไฟฟ้าของท่านเท่านั้น** หากใช้แบตเตอรี่ประเภทอื่น ต. ย. เช่น แบตเตอรี่ที่ลอกเลียนแบบ ซ่อมปรับปรุง หรือแบตเตอรี่ยี่ห้ออื่น จะเกิดอันตรายทำให้ร่างกายบาดเจ็บและทรัพย์สินเสียหายจากการระเบิดของแบตเตอรี่ได้

## วิธีปฏิบัติงานและคำแนะนำ เพื่อความปลอดภัยเพิ่มเติม

- ▶ ผู้ที่ได้จากวัสดุ เช่น เคลือบผิวที่มีตะกั่ว ไม้บางประเภท แร่ธาตุ และโลหะ อาจเป็นอันตรายต่อสุขภาพและทำให้เกิดอาการแพ้ นำไปสู่โรคติดเชื้อในระบบหายใจและ/หรือโรคมะเร็ง ผู้ทำงานกับวัสดุผสมแอสเบสทอสได้ต้องเป็นช่างผู้เชี่ยวชาญเท่านั้น
  - จัดสถานที่ทำงานให้มีการระบายอากาศที่ดี
  - ขอแนะนำให้สวมหน้ากากป้องกันการติดเชื้อที่มีระดับ-ไส้กรอง P2

ปฏิบัติตามกฎข้อบังคับสำคัญอื่นๆ ที่เกี่ยวกับวัสดุชิ้นงานที่บังคับใช้ในประเทศของท่าน

- ▶ ป้องกันการสะสมของฝุ่นในสถานที่ทำงาน ฝุ่นสามารถถูกไหม้อย่างง่ายดาย
- ▶ ก่อนปรับแต่งเครื่อง (ต. ย. เช่น การบำรุงรักษา การเปลี่ยนเครื่องมือ ฯลฯ) รวมทั้งเมื่อเคลื่อนย้ายและเก็บเข้าที่ ให้ตั้งสวิตช์ปรับทิศทางหมุนไว้ที่ตำแหน่งกลางเสมอ หากสวิตช์เปิด-ปิดถูกกดโดยไม่เจตนา อาจทำให้บุคคลบาดเจ็บได้
- ▶ แบตเตอรี่ที่จัดส่งได้ถูกชาร์จมาบ้างแล้ว เพื่อให้แน่ใจว่าแบตเตอรี่จะทำงานได้เต็มที่ ให้ชาร์จแบตเตอรี่อย่างสมบูรณ์แบบในเครื่องชาร์จก่อนนำมาใช้งานครั้งแรก
- ▶ อ่านคู่มือการใช้งานเครื่องชาร์จแบตเตอรี่
- ▶ จับเครื่องมือไฟฟ้าวางบนสกรูเมื่อเครื่องปิดอยู่เท่านั้น เครื่องมือที่กำลังหมุนอยู่สามารถทำให้ลื่นไถลได้
- ▶ ปรับสวิตช์เกียร์เมื่อเครื่องหยุดนิ่งอยู่กับที่แล้วเท่านั้น
- ▶ หากไม่สามารถดันสวิตช์เกียร์จนสุดได้ให้หมุนหัวจับดอกสว่านเล็กน้อย
- ▶ ตั้งบั้งชี้การควบคุมการชาร์จของแบตเตอรี่ประกอบด้วยไฟ LED สีเขียวสามดวง ซึ่งจะแสดงสภาพการชาร์จของแบตเตอรี่นานสองสามวินาทีเมื่อกดสวิตช์เปิด-ปิดครั้งทางหรือเต็มที่

LED	ความจุ
ส่องสว่างต่อเนื่อง 3 x สีเขียว	$\geq 2/3$
ส่องสว่างต่อเนื่อง 2 x สีเขียว	$\geq 1/3$
ส่องสว่างต่อเนื่อง 1 x สีเขียว	$< 1/3$
ไฟกะพริบ 1 x สีเขียว	สำรอง

### สัญลักษณ์

สัญลักษณ์ต่อไปนี้มีความสำคัญต่อการอ่านและการทำความเข้าใจคู่มือการใช้งานเครื่อง กรุณาจดจำสัญลักษณ์และความหมายของสัญลักษณ์ การแปลความสัญลักษณ์ได้ถูกต้องจะช่วยให้คุณใช้เครื่องได้ดีและปลอดภัยกว่า

สัญลักษณ์	ความหมาย
	GSB 10,8-2-LI: สว่านเจาะกระแทกไร้สาย บริเวณสีเทา: ต้มจับ (พื้นผิวจับหุ้มด้วยฉนวน)
	หมายเลขสินค้า
	ต้องอ่านคำเตือนเพื่อความปลอดภัยและคำสั่งทั้งหมด
	ถอดแบตเตอรี่ออก ก่อนทำการปรับแต่งเครื่อง
	ต้องสวมอุปกรณ์ป้องกันหู
	ทิศทางการเคลื่อนที่
	ทิศทางการตอบสนอง
	การหมุนซ้าย/ขวา
	สกรู
	การเจาะโดยไม่กระแทก
	การเจาะกระแทก
	ความเร็วต่ำ
	ความเร็วสูง
	เปิดเครื่องทำงาน
	ปิดเครื่อง
	ไฟเตือนการชาร์จแบตเตอรี่
U	แรงดันไฟฟ้ากำหนด
n <sub>0</sub> 1	ความเร็วเดินตัวเปล่า (เกียร์ 1)
n <sub>0</sub> 2	ความเร็วเดินตัวเปล่า (เกียร์ 2)

## 22 | ภาษาไทย

สัญลักษณ์	ความหมาย
n <sub>s</sub>	อัตรากระแทก
M	แรงบิดสูงสุด ตามมาตรฐาน ISO 5393
	งานก่ออิฐ
	โลหะ
	ไม้
	เส้นผ่าศูนย์กลางรูเจาะ สูงสุด
	Ø-สกรู สูงสุด
	วงหนีบหัวจับดอก
	น้ำหนักตามระเบียบการ-EPTA- Procedure 01:2014
*	ขึ้นอยู่กับแบตเตอรี่แพ็คที่ใช้

## รายการสิ่งของที่จัดส่ง

สว่านเจาะกระแทกไร้สายแบตเตอรี่ เครื่องมือ และอุปกรณ์ประกอบอื่นๆ ที่แสดงหรือระบุไม่รวมอยู่ในการจัดส่งมาตรฐาน

## การประกอบและการปฏิบัติงาน

ขั้นตอน	ภาพประกอบ	หน้า
การถอดแบตเตอรี่	1	34
การใส่แบตเตอรี่	2	34
การประกอบเครื่องมือ	3	34
การกลับทิศทางการหมุน	4	35
การตั้งแรงบิด	5	35
การตั้งวิธีการปฏิบัติงาน	6	36
การเลือกเกียร์ ระบบกลไก	7	36
การเปิดและปิดสวิตช์	8	37
การตรวจสอบสภาพการชาร์จแบตเตอรี่	9	37
การเลือกอุปกรณ์ประกอบ	-	38

## การบำรุงรักษาและการทำความสะอาด

► เพื่อให้ทำงานได้อย่างถูกต้องและปลอดภัย ต้องรักษาเครื่องและช่องระบายอากาศให้สะอาดอยู่เสมอ

## การบริการหลังการขายและคำแนะนำการใช้งาน

ศูนย์บริการหลังการขายของเรายินดีตอบคำถามเกี่ยวกับการบำรุงรักษาและการซ่อมแซมผลิตภัณฑ์ของท่าน รวมทั้ง

กรุณาดูการอธิบายโดยสรุปทั้งหมดในโปรแกรมอุปกรณ์ประกอบของเรา

## ประโยชน์การใช้งานของเครื่อง

เครื่องนี้ใช้สำหรับขันสกรูเข้าและคลายสกรูออก และใช้เจาะในไม้ โลหะ เซรามิก และพลาสติก นอกจากนี้ยังใช้เจาะกระแทกในอิฐ งานก่ออิฐ และหิน

## ข้อมูลทางเทคนิค

ข้อมูลทางเทคนิคของเครื่องได้ลงรายการไว้ในตารางหน้า 33 ของคู่มือการใช้งานเครื่องเล่มนี้

เครื่องแต่ละเครื่องอาจมีชื่อทางการค้าแตกต่างกัน ดังนั้น กรุณาสังเกตหมายเลขสินค้าบนแผ่นป้ายรุ่นของเครื่องของท่าน

ชิ้นส่วนอะไหล่ ภาพแยกชิ้นประกอบและข้อมูลเกี่ยวกับชิ้นส่วนอะไหล่ยังสามารถดูได้ใน:

[www.bosch-pt.com](http://www.bosch-pt.com)

ทีมงานให้คำแนะนำการใช้งานของ บ็อช ยินดีตอบคำถามเกี่ยวกับผลิตภัณฑ์ของเราและอุปกรณ์ประกอบของผลิตภัณฑ์ เมื่อต้องการสอบถามและสั่งซื้ออะไหล่ กรุณาแจ้งหมายเลขสินค้าหลักบนแผ่นป้ายรุ่นของเครื่องทุกครั้ง ในกรณีประกัน ซ่อมแซม หรือซื้อชิ้นส่วนมาเปลี่ยน กรุณาติดต่อ ผู้ขายที่ได้รับแต่งตั้งเท่านั้น

**ไทย**

บริษัท โรเบิร์ต บ็ช จำกัด  
 ชั้น 11 ดิกลีเบอร์ตี สแควร์  
 287 ถนนสีลม บางรัก  
 กรุงเทพฯ 10500  
 โทรศัพท์ 02 63931111, 02 63931118  
 โทรสาร 02 2384783  
 บริษัท โรเบิร์ต บ็ช จำกัด ตู ปณ. 2054  
 กรุงเทพฯ 10501 ประเทศไทย  
 www.bosch.co.th

ศูนย์บริการซ่อมและฝึกอบรม บ็ช  
 อาคาร ลาซาลทาวเวอร์ ชั้น G ห้องเลขที่ 2  
 บ้านเลขที่ 10/11 หมู่ 16  
 ถนนศรีนครินทร์  
 ตำบลบางแก้ว อำเภอบางพลี  
 จังหวัดสมุทรปราการ 10540  
 ประเทศไทย  
 โทรศัพท์ 02 7587555  
 โทรสาร 02 7587525

**การขนส่ง**

แบตเตอรี่ลิเธียม ไอออน ที่บรรจุอยู่ภายใต้ข้อกำหนดแห่ง  
 กฎหมายสินค้าอันตราย ผู้ใช้สามารถขนส่งแบตเตอรี่โดยทาง  
 ถนนโดยไม่มีข้อบังคับอื่น  
 หากขนส่งโดยบุคคลที่สาม (เช่น: การขนส่งทางอากาศ หรือ  
 ตัวแทนขนส่งสินค้า) ต้องปฏิบัติตามข้อกำหนดพิเศษเกี่ยวกับ  
 การบรรจุภัณฑ์และการติดฉลาก ในการจัดเตรียมสิ่งของที่จะ  
 จัดส่ง ต้องปรึกษาผู้เชี่ยวชาญสำหรับวัตถุนั้น  
 ส่งแบตเตอรี่เมื่อตัวหุ้มไม่ชำรุดเสียหายเท่านั้น ใช้แถบกาวพัน  
 ปิดหน้าสัมผัสที่เปิดอยู่ และนำแบตเตอรี่ใส่กล่องบรรจุโดย  
 ไม่ให้เคลื่อนไปมาในกล่องได้  
 นอกจากนี้กรุณาปฏิบัติตามกฎระเบียบของประเทศซึ่งอาจมี  
 รายละเอียดเพิ่มเติม

**การกำจัดขยะ**

 เครื่อง แบตเตอรี่ที่นำกลับมาชาร์จใหม่ได้ อุปกรณ์  
 ประกอบ และหีบห่อ ต้องนำไปแยกประเภทวัสดุ  
 เพื่อนำกลับมาใช้ใหม่โดยไม่ทำลายสภาพแวดล้อม  
 อย่างทั้งเครื่องมือไฟฟ้าและแบตเตอรี่/แบตเตอรี่ที่นำกลับมา  
 ชาร์จใหม่ได้ ลงในขยะบ้าน!

**แบตเตอรี่แพ็ค/แบตเตอรี่:****Li-ion:**

กรุณาปฏิบัติตามคำสั่งในบท  
 "การขนส่ง" หน้า 23

ขอสงวนสิทธิ์ในการเปลี่ยนแปลงโดยไม่ต้องแจ้งล่วงหน้า

**Bahasa Indonesia****Petunjuk-Petunjuk Umum untuk  
Perkakas Listrik****PERHATIKANLAH**

Bacalah semua petunjuk-  
 petunjuk untuk keselamatan  
 kerja dan petunjuk-petunjuk untuk penggunaan.

Kesalahan dalam menjalankan petunjuk-petunjuk untuk  
 keselamatan kerja dan petunjuk-petunjuk untuk penggunaan  
 dapat mengakibatkan kontak listrik, kebakaran dan/atau luka-  
 luka yang berat.

Simpanlah semua petunjuk-petunjuk untuk keselamatan  
 kerja dan petunjuk-petunjuk lainnya untuk penggunaan di  
 masa depan.

Kata „perkakas listrik“ yang disebutkan di dalam petunjuk-  
 petunjuk untuk keselamatan kerja adalah sebutan untuk  
 perkakas listrik pakai listrik jaringan (dengan kabel) dan  
 untuk perkakas listrik tenaga baterai (tanpa kabel listrik).

**Keselamatan kerja di tempat kerja**

- ▶ **Jagalah supaya tempat kerja selalu bersih dan terang.**  
Tempat kerja yang tidak rapi atau tidak terang dapat  
mengakibatkan terjadinya kecelakaan.
- ▶ **Janganlah menggunakan perkakas listrik di tempat di  
mana dapat terjadi ledakan, di mana ada cairan, gas  
atau debu yang mudah terbakar.** Perkakas listrik dapat  
memancarkan bunga api yang lalu mengakibatkan debu  
atau uap terbakar.
- ▶ **Selama menggunakan perkakas listrik, jauhkan anak-  
anak dan orang-orang lain dari tempat kerja.** Jika  
konsentrasi terganggu, bisa jadi Anda tidak bisa mengem-  
pulkan perkakas listrik tersebut.

**Keamanan listrik**

- ▶ **Steker dari perkakas listrik harus cocok pada  
stopkontak. Janganlah sekali-kali merubah steker.**  
**Janganlah menggunakan steker perantara bersama  
dengan perkakas listrik yang mempunyai hubungan  
arde.** Steker yang tidak dirubah dan stopkontak yang  
cocok mengurangi bahaya terjadinya kontak listrik.
- ▶ **Jagalah supaya badan Anda tidak bersentuhan dengan  
permukaan yang mempunyai hubungan arde, misalnya  
pipa-pipa, radiator pemanas ruangan, kompor listrik**

## 24 | Bahasa Indonesia

**dan lemari es.** Ada risiko besar terjadi kontak listrik, jika badan Anda mempunyai hubungan arde.

- ▶ **Jagalah supaya perkakas listrik tidak kena hujan atau menjadi basah.** Air yang masuk ke dalam perkakas listrik menambah risiko terjadinya kontak listrik.
- ▶ **Janganlah menyalah gunakan kabel listrik untuk mengangkat dan menggantungkan perkakas listrik atau untuk menarik steker dari stopkontak.** Jagalah supaya kabel listrik tidak kena panas, minyak, pinggiran yang tajam atau bagian-bagian perkakas yang bergerak. Kabel listrik yang rusak atau tersangkut menambah risiko terjadinya kontak listrik.
- ▶ **Jika Anda menggunakan perkakas listrik di luar gedung, gunakanlah hanya kabel sambungan yang juga cocok untuk pemakaian di luar gedung.** Penggunaan kabel sambungan yang cocok untuk pemakaian di luar gedung mengurangi risiko terjadinya kontak listrik.
- ▶ **Jika penggunaan perkakas listrik di tempat yang basah tidak bisa dihindarkan, gunakanlah sakelar pengaman terhadap arus penyimpangan.** Penggunaan sakelar pengaman terhadap arus penyimpangan mengurangi risiko terjadinya kontak listrik.

**Keselamatan kerja**

- ▶ **Berhati-hatilah selalu, perhatikanlah apa yang Anda kerjakan dan bekerjalah dengan seksama jika menggunakan perkakas listrik.** Janganlah menggunakan perkakas listrik, jika Anda capai atau berada di bawah pengaruh narkoba, minuman keras atau obat. Jika Anda sekejap mata saja tidak berhati-hati sewaktu menggunakan perkakas listrik, dapat terjadi luka-luka berat.
- ▶ **Pakailah pakaian dan sarana pelindung dan pakailah selalu kaca mata pelindung.** Dengan memakai pakaian dan sarana pelindung, misalnya kedok anti debu (masker), sepatu tertutup yang tidak licin, helm pelindung atau pemalut telinga sesuai dengan pekerjaan yang dilakukan dengan perkakas listrik, bahaya terjadinya luka-luka dapat dikurangi.
- ▶ **Jagalah supaya perkakas listrik tidak dihidupkan secara tidak disengaja.** Perhatikan bahwa perkakas listrik dalam penyetelan mati, jika steker disambungkan pada pengadaan listrik dan/atau baterai, jika perkakas listrik diangkat atau dibawa. Jika selama mengangkat perkakas listrik jari Anda berada pada tombol untuk menghidupkan dan mematikan atau perkakas listrik yang dalam penyetelan hidup disambungkan pada listrik, dapat terjadi kecelakaan.
- ▶ **Lepaskan semua perkakas-perkakas penyetelan atau kunci-kunci pas sebelum perkakas listrik dihidupkan.** Perkakas atau kunci yang berada di dalam bagian yang berputar dapat mengakibatkan terjadinya luka-luka.
- ▶ **Aturkan badan sedemikian sehingga Anda bisa bekerja dengan aman. Berdirilah secara mantap dan jagalah selalu keseimbangan.** Dengan demikian Anda bisa mengendalikan perkakas listrik dengan lebih baik, jika terjadi sesuatu dengan tiba-tiba.

- ▶ **Pakailah pakaian yang cocok. Janganlah memakai pakaian yang longgar atau perhiasan. Jagalah supaya rambut, pakaian dan sarung tangan tidak masuk dalam bagian-bagian perkakas yang bergerak.** Pakaian yang longgar, rambut panjang atau perhiasan dapat tersangkut dalam bagian perkakas yang bergerak.
- ▶ **Jika ada kemungkinan untuk memasangkan sarana penghisapan dan penampungan debu, perhatikan bahwa sarana-sarana ini telah dipasangkan dan digunakan dengan betul.** Penggunaan sarana penghisapan bisa mengurangi bahaya yang disebabkan debu.

**Penggunaan dan penanganan perkakas listrik dengan seksama**

- ▶ **Janganlah membebankan perkakas listrik terlalu berat. Gunakan selalu perkakas listrik yang cocok untuk pekerjaan yang dilakukan.** Dengan perkakas listrik yang cocok Anda bekerja lebih baik dan lebih aman dalam batas-batas kemampuan yang ditentukan.
- ▶ **Janganlah menggunakan perkakas listrik yang tombolnya rusak.** Perkakas listrik yang tidak bisa dihidupkan atau dimatikan, berbahaya dan harus direparasikan.
- ▶ **Tariklah steker dari stopkontak dan/atau keluarkan baterai, sebelum Anda melakukan penyetelan pada perkakas listrik, mengganti alat-alat kerja atau sebelum menyimpan perkakas listrik.** Tindakan keselamatan kerja ini mengurangi bahaya perkakas listrik hidup secara tidak disengaja.
- ▶ **Simpanlah perkakas listrik yang tidak digunakan di luar jangkauan anak-anak. Janganlah mengizinkan orang-orang yang tidak mengenal perkakas listrik ini atau yang belum membaca petunjuk-petunjuk ini, menggunakan perkakas listrik ini.** Perkakas listrik bisa menjadi berbahaya, jika digunakan oleh orang-orang yang tidak mengenalnya.
- ▶ **Rawatlah perkakas listrik dengan seksama. Periksalah, apakah bagian-bagian perkakas listrik yang bergerak berfungsi dengan baik dan tidak tersangkut, apakah ada bagian-bagian yang patah atau rusak sedemikian, sehingga dapat mempengaruhi jalannya perkakas listrik. Biarkan bagian-bagian perkakas yang rusak direparasikan, sebelum Anda mulai menggunakan perkakas listrik.** Banyak kecelakaan terjadi karena perkakas listrik tidak dirawat dengan seksama.
- ▶ **Perhatikan supaya alat-alat pemotong selalu tajam dan bersih.** Alat-alat pemotong dengan mata-mata pemotong yang tajam dan dirawat dengan seksama tidak mudah tersangkut dan lebih mudah dikendalikan.
- ▶ **Gunakanlah semua perkakas listrik, aksesoris, alat-alat kerja dsb. sesuai dengan petunjuk-petunjuk. Perhatikan syarat-syarat kerja dan macam pekerjaan yang dilakukan.** Penggunaan perkakas listrik untuk macam pekerjaan yang tidak cocok dengan kegunaannya bisa mengakibatkan keadaan yang berbahaya.



### Penanganan dan penggunaan perkakas-perkakas pakai baterai dengan seksama

- ▶ **Isikan baterai hanya dalam alat-alat pencas baterai yang dianjurkan oleh pabrik.** Jika suatu alat pencas baterai yang cocok untuk mengisi satu macam baterai tertentu, digunakan untuk mengisi baterai-baterai lainnya, ada bahaya terjadinya kebakaran.
- ▶ **Gunakanlah hanya baterai-baterai yang cocok dan khusus untuk masing-masing perkakas listrik.** Penggunaan baterai-baterai lain dapat mengakibatkan terjadinya luka-luka dan kebakaran.
- ▶ **Jika baterai tidak digunakan, jauhkan baterai dari klip untuk kertas, uang logam, kunci, paku, sekrup atau benda-benda kecil dari logam lainnya, yang dapat menjembatani kontak-kontak.** Korsleting antara kontak-kontak baterai dapat mengakibatkan kebakaran atau api.
- ▶ **Jika baterai tidak digunakan dengan betul, dapat keluar cairan dari baterai.** Jagalah supaya Anda tidak terkena pada cairan ini. Jika secara tidak disengaja Anda terkena pada cairan ini, cucikan dengan air. Jika cairan tersebut terkena pada mata, selain tindakan di atas, segera hubungi seorang dokter. Cairan yang keluar dari baterai dapat mengakibatkan gangguan pada kulit atau kebakaran.

### Servis

- ▶ **Biarkan perkakas listrik Anda direparasikan hanya oleh orang-orang ahli yang berpengalaman dan hanya dengan menggunakan suku cadang yang asli.** Dengan demikian terjamin keselamatan kerja dengan perkakas listrik ini secara berkesinambungan.

### Petunjuk-Petunjuk untuk Keselamatan Kerja untuk Mesin Bor dan Obeng Elektro

- ▶ **Pakailah pemalut telinga selama membor dengan getaran.** Jika Anda mendengar suara bising, daya pendengaran bisa berkurang.
- ▶ **Gunakanlah gagang tambahan-gagang tambahan, jika ini dipasok bersama dengan perkakas listrik.** Perkakas listrik yang tidak bisa dikendalikan bisa mengakibatkan terjadinya luka-luka.
- ▶ **Peganglah perkakas listrik hanya pada pegangan yang terisolir, jika Anda melakukan pekerjaan di mana alat kerjanya atau sekrup bisa terkena pada saluran listrik yang tidak terlihat.** Sentuhan pada kabel yang bertegangan dapat mengakibatkan bagian-bagian logam dari perkakas listrik juga bertegangan dan lalu mengakibatkan kontak listrik.
- ▶ **Gunakanlah alat detektor logam yang cocok untuk mencari kabel dan pipa pengadaan yang tidak terlihat, atau hubungi perusahaan pengadaan setempat.** Sentuhan dengan kabel-kabel listrik bisa mengakibatkan api dan kontak listrik. Pipa gas yang rusak bisa mengakibatkan ledakan. Pipa air yang rusak mengakibatkan barang-barang menjadi rusak.

- ▶ **Matikanlah segera perkakas listrik, jika alat kerjanya memblok.** Berwaspadalah akan terjadinya momen reaksi yang besar yang mengakibatkan bantingan. Alat kerja memblok jika:
  - perkakas listrik dibebankan terlalu berat atau
  - alat kerja tersangkut dalam benda yang dikerjakan.
- ▶ **Peganglah perkakas listrik secara kencang.** Pada waktu memutar masuk dan memutar ke luar sekrup bisa terjadi momen yang besar untuk waktu yang singkat.
- ▶ **Usahakan supaya benda yang dikerjakan tidak goyang.** Benda yang ditahan dalam alat pemegang atau bais lebih mantap daripada benda yang dipegang dengan tangan.
- ▶ **Sebelum meletakkan perkakas listrik, tunggulah sampai perkakas berhenti memutar.** Alat kerja bisa tersangkut dan membuat perkakas listrik tidak bisa dikendalikan.
- ▶ **Janganlah membuka baterai.** Ada bahaya terjadinya korsleting.
  -  **Lindungilah baterai terhadap panas, misalnya juga terhadap penyinaran matahari yang lama, api, air dan kelembaban.** Ada bahaya terjadinya ledakan.
- ▶ **Jika baterai rusak dan jika baterai digunakan salah, baterai bisa mengeluarkan uap.** Biarkan udara segar mengalir masuk dan jika Anda merasa tidak enak badan, pergilah ke dokter. Uap tersebut bisa mengganggu saluran pernafasan.
- ▶ **Gunakanlah baterai hanya bersama dengan perkakas listrik merek Bosch.** Hanya dengan demikian baterai dilindungi terhadap pembebanan terlalu berat yang berbahaya.
- ▶ **Gunakanlah hanya baterai asli yang bermerek Bosch dengan tegangan yang tercantum pada label tipe perkakas listrik.** Jika digunakan baterai lainnya, misalnya baterai tiruan, baterai lama yang diperbarui atau baterai yang bermerek lain, bisa terjadi luka-luka serta kerusakan pada benda yang disebabkan oleh baterai yang meledak.

### Petunjuk-petunjuk lainnya untuk keselamatan kerja dan untuk penggunaan

- ▶ **Debu dari berbagai bahan misalnya cat yang mengandung timbel, beberapa jenis kayu, bahan mineral dan logam bisa berbahaya bagi kesehatan dan mengakibatkan reaksi alergi, penyakit saluran pernafasan dan/atau kanker.** Bahan-bahan yang mengandung asbestos hanya boleh dikerjakan oleh orang-orang ahli yang berpengalaman.
  - Perhatikanlah supaya ada pertukaran udara di tempat kerja.
  - Kami anjurkan supaya Anda memakai kedok anti debu dengan saringan (filter) kelas P2.
 Taatilah peraturan-peraturan untuk bahan-bahan yang dikerjakan yang berlaku di negara Anda.

26 | Bahasa Indonesia





- ▶ **Hindari debu yang banyak terkumpul di tempat kerja.** Debu dapat menyulut dengan mudahnya.
- ▶ **Sebelum melakukan semua pekerjaan pada perkakas listrik (misalnya merawat, mengganti alat kerja dsb.) serta selama mentranspor dan menyimpan perkakas listrik, putarkan pengubah arah putaran ke kedudukan tengah.** Jika tombol untuk menghidupkan dan mematikan mesin digerakkan tanpa sengaja, bisa terjadi luka-luka.
- ▶ **Baterai dipasok dalam keadaan diisi sebagian. Untuk menjamin daya penuh dari baterai, sebelum penggunaannya untuk pertama kalinya, isikanlah baterai sampai penuh sama sekali di dalam alat pencas baterai.**
- ▶ **Bacalah petunjuk-petunjuk untuk penggunaan alat pencas baterai.**
- ▶ **Pasangkan perkakas listrik pada sekrup hanya jika perkakas listrik dalam keadaan mati.** Alat kerja-alat kerja yang berputar bisa meleset.
- ▶ **Sakelar untuk memilih tingkatan putaran hanya boleh digerakkan, jika perkakas listrik sedang berhenti.**
- ▶ **Jika sakelar untuk memilih tingkatan putaran tidak bisa digeserkan sampai batas, putarkan sedikit cekaman mata bor.**
- ▶ Jika tombol untuk menghidupkan dan mematikan ditekan sampai batas atau ditekan sampai separuh, petanda keberisian baterai yang terdiri dari 3 lampu LED hijau, menampilkan keberisian baterai selama beberapa detik.

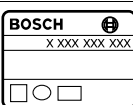

LED	Kapasitas
Lampu menetap 3 x hijau	≥ 2/3
Lampu menetap 2 x hijau	≥ 1/3
Lampu menetap 1 x hijau	< 1/3
Lampu berkedip-kedip 1 x hijau	cadangan

**Simbol-Simbol**

Simbol-simbol berikut penting pada waktu membaca dan untuk mengerti petunjuk-petunjuk untuk penggunaan. Lihat dan ingati simbol-simbol dan artinya. Penafsiran yang betul dari simbol-simbol sangat membantu Anda untuk menggunakan perkakas listrik dengan jitu dan sesuai dengan petunjuk untuk keselamatan kerja.

Simbol	Arti
	GSB 10,8-2-LI: Mesin kunci/bor getaran nirkabel Bidang berwarna abu-abu: gagang (permukaan yang dipegang dengan isolasi)
	Nomor model x xxx xxx xxx

Simbol	Arti
	Bacalah semua petunjuk-petunjuk untuk keselamatan kerja dan petunjuk-petunjuk untuk penggunaan
	Sebelum memulai semua pekerjaan pada perkakas listrik, keluarkanlah dahulu baterai
	Pakailah pemalut telinga.
	Arah gerakan
	Arah reaksi
	Putaran ke kanan/kiri
	Baut-baut
	Membor tanpa getaran
	Membor dengan getaran
	Kecepatan putaran rendah
	Kecepatan putaran tinggi
	Menghidupkan perkakas listrik
	Mematikan perkakas listrik
	Petanda keberisian baterai
U	Tegangan nominal
$n_0 1$	Kecepatan putaran tanpa beban (tingkatan putaran ke 1)
$n_0 2$	Kecepatan putaran tanpa beban (tingkatan putaran ke 2)
$n_s$	Banyaknya getaran
M	Momen putar maks. menurut ISO 5393
	Tembok
	Logam
	Kayu
$\emptyset$	Diameter maks. pemboran
	$\emptyset$ -sekrup maks.

Simbol	Arti
	Kepala cekam yang bisa memegang mata bor
	Berat sesuai dengan EPTA-Procedure 01:2014
*	tergantung dari baterai yang digunakan

### Pasokan standar

Mesin kunci/bor getaran nirkabel.  
Baterai, alat kerja dan aksesoris lainnya yang ada dalam gambar atau yang dijelaskan, tidak termasuk dalam mesin standar yang dipasok.  
Semua aksesoris yang tersedia dapat Anda lihat di dalam program aksesoris.

### Memasang dan menggunakan

Kegiatan	Gambar	Halaman
Cara mengeluarkan baterai	<b>1</b>	34
Memasang baterai	<b>2</b>	34
Memasang alat kerja	<b>3</b>	34
Menyetel arah putaran	<b>4</b>	35
Penyetelan pendahuluan momen putar	<b>5</b>	35
Menyetel macam pekerjaan	<b>6</b>	36
Memilih tingkatan putaran secara mekanis	<b>7</b>	36
Menghidupkan/mematikan	<b>8</b>	37
Memeriksa keberisian baterai	<b>9</b>	37
Memilih aksesoris	-	38

### Rawatan dan kebersihan

- **Perkakas listrik dan lubang ventilasi harus selalu dibersihkan supaya perkakas bisa digunakan dengan baik dan aman.**

### Layanan pasca beli dan konseling terkait pengoperasian

Layanan pasca beli Bosch menjawab semua pertanyaan Anda terkait reparasi dan maintenance serta suku cadang produk ini. Gambar tiga dimensi dan informasi terkait suku cadang dapat Anda lihat di:

**www.bosch-pt.com**

Tim konseling pengoperasian dari Bosch dengan senang hati membantu Anda, jika Anda hendak bertanya tentang produk-produk kami dan aksesorisnya.

Jika Anda hendak menanyakan sesuatu atau memesan suku cadang, sebutkan selalu nomor model yang terdiri dari 10 angka dan tercantum pada label tipe perkakas.

### Penggunaan alat

Perkakas listrik ini cocok untuk memutar masuk dan memutar ke luar sekrup dan baut serta untuk membor di kayu, logam, keramik dan bahan sintetik dan untuk membor pakai getaran di batu bata, tembok dan batu-batuan.

### Data teknis

Data-data teknis dari produk ini tertera di dalam tabel pada halaman 33 dari petunjuk-petunjuk untuk penggunaan ini. Perhatikanlah nomor model perkakas listrik Anda yang tercantum pada label tipe mesin. Nama dagang dari beberapa perkakas listrik bisa berbeda.

#### Indonesia

PT. Multi Mayaka  
Kawasan Industri Pulogadung  
Jalan Rawa Gelam III No. 2  
Jakarta 13930  
Indonesia  
Tel.: (021) 46832522  
Fax: (021) 46828645/6823  
E-Mail: sales@multimayaka.co.id  
www.bosch-pt.co.id

### Transpor

Pada baterai-baterai ion-Li yang digunakan diterapkan persyaratan terkait peraturan-peraturan tentang bahan-bahan yang berbahaya. Baterai-baterai dapat diangkat oleh penggunaannya di jalanan tanpa harus memenuhi syarat-syarat tertentu.

Pada pengiriman oleh pihak ketiga (misalnya transportasi dengan pesawat udara atau perusahaan ekspedisi) harus ditaati syarat-syarat terkait kemasan dan pemberian tanda. Dalam hal ini, untuk mempersiapkan transportasi harus diminta dukungan seorang ahli bahan-bahan berbahaya.

## 28 | Tiếng Việt

Kirimkan baterai hanya jika rumahnya tidak rusak. Kontak-kontak yang terbuka harus ditutupi dengan pita perekat dan kemaskan baterai sedemikian, sehingga baterai tidak bergerak-garak di dalam kemasan.  
Tautilah peraturan-peraturan nasional lainnya yang mungkin lebih rinci yang berlaku di negara Anda.

### Cara membuang

 Semua perkakas listrik, baterai, aksesoris dan kemasan sebaiknya didaur ulangkan sesuai dengan upaya untuk melindungi lingkungan hidup.

Janganlah membuang perkakas listrik, baterai isi ulang/baterai ke dalam sampah rumah tangga!

#### Baterai isi ulang/Baterai:



**Ion-Li:**  
Perhatikanlah petunjuk-petunjuk dalam bab „Transpor“, halaman 27.

Perubahan adalah hak Bosch.

## Tiếng Việt

### Cảnh báo tổng quát cách sử dụng an toàn dụng cụ điện cầm tay

**⚠ CẢNH BÁO** Đọc kỹ mọi cảnh báo an toàn và hướng dẫn. Không tuân thủ mọi cảnh báo và hướng dẫn được liệt kê dưới đây có thể bị điện giật, gây cháy và/hay bị thương tật nghiêm trọng.

**Hãy giữ tất cả tài liệu về cảnh báo và hướng dẫn để tham khảo về sau.**

Thuật ngữ “dụng cụ điện cầm tay” trong phần cảnh báo là để cập đến sự sử dụng dụng cụ điện cầm tay của bạn, loại sử dụng điện nguồn (có dây cắm điện) hay vận hành bằng pin (không dây cắm điện).

#### Khu vực làm việc an toàn

- ▶ **Giữ nơi làm việc sạch và đủ ánh sáng.** Nơi làm việc bừa bộn và tối tăm dễ gây ra tai nạn.
- ▶ **Không vận hành dụng cụ điện cầm tay trong môi trường dễ gây nổ, chẳng hạn như nơi có chất lỏng dễ cháy, khí đốt hay rác.** Dụng cụ điện cầm tay tạo ra các tia lửa nên có thể làm rác bén cháy hay bốc khói.
- ▶ **Không để trẻ em hay người đến xem đứng gần khi vận hành dụng cụ điện cầm tay.** Sự phân tâm có thể gây ra sự mất điều khiển.

### An toàn về điện

- ▶ **Phích cắm của dụng cụ điện cầm tay phải thích hợp với ổ cắm. Không bao giờ được cải biến lại phích cắm dưới mọi hình thức. Không được sử dụng phích tiếp hợp nối tiếp đất (dây mát).** Phích cắm nguyên bản và ổ cắm đúng loại sẽ làm giảm nguy cơ bị điện giật.
- ▶ **Tránh không để thân thể tiếp xúc với đất hay các vật có bề mặt tiếp đất như đường ống, lò sưởi, hàng rào và tủ lạnh.** Có nhiều nguy cơ bị điện giật hơn nếu cơ thể bạn bị tiếp hay nối đất.
- ▶ **Không được để dụng cụ điện cầm tay ngoài mưa hay ở tình trạng ẩm ướt.** Nước vào máy sẽ làm tăng nguy cơ bị điện giật.
- ▶ **Không được lạm dụng dây dẫn điện. Không bao giờ được nắm dây dẫn để xách, kéo hay rút phích cắm dụng cụ điện cầm tay. Không để dây gần nơi có nhiệt độ cao, dầu nhớt, vật nhọn bén hay bộ phận chuyển động.** Làm hỏng hay cuộn rối dây dẫn làm tăng nguy cơ bị điện giật.
- ▶ **Khi sử dụng dụng cụ điện cầm tay ngoài trời, dùng dây nối thích hợp cho việc sử dụng ngoài trời.** Sử dụng dây nối thích hợp cho việc sử dụng ngoài trời làm giảm nguy cơ bị điện giật.
- ▶ **Nếu việc sử dụng dụng cụ điện cầm tay ở nơi ẩm ướt là không thể tránh được, dùng thiết bị ngắt mạch tự động (RCD) bảo vệ nguồn.** Sử dụng thiết bị ngắt mạch tự động RCD làm giảm nguy cơ bị điện giật.

### An toàn cá nhân

- ▶ **Hãy tỉnh táo, biết rõ mình đang làm gì và hãy sử dụng ý thức khi vận hành dụng cụ điện cầm tay. Không sử dụng dụng cụ điện cầm tay khi đang mệt mỏi hay đang bị tác động do chất gây nghiện, rượu hay dược phẩm gây ra.** Một thoáng mắt tập trung khi đang vận hành dụng cụ điện cầm tay có thể gây thương tích nghiêm trọng cho bản thân.
- ▶ **Sử dụng trang bị bảo hộ cá nhân. Luôn luôn đeo kính bảo vệ mắt.** Trang bị bảo hộ như khẩu trang, giày chống trượt, nón bảo hộ, hay dụng cụ bảo vệ tai khi được sử dụng đúng nơi đúng chỗ sẽ làm giảm nguy cơ thương tật cho bản thân.
- ▶ **Phòng tránh máy khởi động bất ngờ. Bảo đảm công tắc máy ở vị trí tắt trước khi cắm vào nguồn điện và/hay lắp pin vào, khi nhắc máy lên hay khi mang xách máy.** Ngáng ngón tay vào công tắc máy để xách hay kích hoạt dụng cụ điện cầm tay khi công tắc ở vị trí mở dễ dẫn đến tai nạn.

- ▶ **Lấy mọi chìa hay khóa điều chỉnh ra trước khi mở điện dụng cụ điện cầm tay.** Khóa hay chìa còn gắn dính vào bộ phận quay của dụng cụ điện cầm tay có thể gây thương tích cho bản thân.
- ▶ **Không rướn người. Luôn luôn giữ tư thế đứng thích hợp và thẳng bằng.** Điều này tạo cho việc điều khiển dụng cụ điện cầm tay tốt hơn trong mọi tình huống bất ngờ.
- ▶ **Trang phục thích hợp. Không mặc quần áo rộng lòng thùng hay mang trang sức. Giữ tóc, quần áo và găng tay xa khỏi các bộ phận chuyển động.** Quần áo rộng lòng thùng, đồ trang sức hay tóc dài có thể bị cuốn vào các bộ phận chuyển động.
- ▶ **Nếu có các thiết bị đi kèm để nối máy hút bụi và các phụ kiện khác, bảo đảm các thiết bị này được nối và sử dụng tốt.** Việc sử dụng các thiết bị gom hút bụi có thể làm giảm các độc hại liên quan đến bụi gây ra.

#### Sử dụng và bảo dưỡng dụng cụ điện cầm tay

- ▶ **Không được ép máy. Sử dụng dụng cụ điện cầm tay đúng loại theo đúng ứng dụng của bạn.** Dụng cụ điện cầm tay đúng chức năng sẽ làm việc tốt và an toàn hơn theo đúng tiến độ mà máy được thiết kế.
- ▶ **Không sử dụng dụng cụ điện cầm tay nếu như công tắc không tắt và mở được.** Bất kỳ dụng cụ điện cầm tay nào mà không thể điều khiển được bằng công tắc là nguy hiểm và phải được sửa chữa.
- ▶ **Rút phích cắm ra khỏi nguồn điện và/hay pin ra khỏi dụng cụ điện cầm tay trước khi tiến hành bất kỳ điều chỉnh nào, thay phụ kiện, hay cắt dụng cụ điện cầm tay.** Các biện pháp ngăn ngừa như vậy làm giảm nguy cơ dụng cụ điện cầm tay khởi động bất ngờ.
- ▶ **Cất giữ dụng cụ điện cầm tay không dùng tới nơi trẻ em không lấy được và không cho người chưa từng biết dụng cụ điện cầm tay hay các hướng dẫn này sử dụng dụng cụ điện cầm tay.** Dụng cụ điện cầm tay nguy hiểm khi ở trong tay người chưa được chỉ cách sử dụng.
- ▶ **Bảo quản dụng cụ điện cầm tay.** Kiểm tra xem các bộ phận chuyển động có bị sai lệch hay kẹt, các bộ phận bị rạn nứt và các tình trạng khác có thể ảnh hưởng đến sự vận hành của máy. Nếu bị hư hỏng, phải sửa chữa máy trước khi sử dụng. Nhiều tai nạn xảy ra do bảo quản dụng cụ điện cầm tay tồi.

- ▶ **Giữ các dụng cụ cắt bén và sạch.** Bảo quản đúng cách các dụng cụ cắt có cạnh cắt bén làm giảm khả năng bị kẹt và dễ điều khiển hơn.
- ▶ **Sử dụng dụng cụ điện cầm tay, phụ kiện, đầu cài v. v., đúng theo các chỉ dẫn này, hãy lưu ý đến điều kiện làm việc và công việc phải thực hiện.** Sử dụng dụng cụ điện cầm tay khác với mục đích thiết kế có thể tạo nên tình huống nguy hiểm.

#### Sử dụng và bảo quản dụng cụ dùng pin

- ▶ **Chỉ được sạc pin lại với bộ nạp điện do nhà sản xuất chỉ định.** Bộ nạp điện thích hợp cho một loại pin có thể gây nguy cơ cháy khi sử dụng cho một loại pin khác.
- ▶ **Chỉ sử dụng dụng cụ điện cầm tay với loại pin được thiết kế đặt biệt dành riêng cho máy.** Sử dụng bất cứ loại pin khác có thể dẫn đến thương tật hay cháy.
- ▶ **Khi không sử dụng pin, để cách xa các vật bằng kim loại như kẹp giấy, tiền xu, chìa khoá, đinh, ốc vít hay các đồ vật kim loại nhỏ khác, thứ có thể tạo sự nối tiếp từ một đầu cực với một đầu cực khác.** Sự chập mạch của các đầu cực với nhau có thể gây bỏng hay cháy.
- ▶ **Bảo quản ở tình trạng tối, dung dịch từ pin có thể tứa ra; tránh tiếp xúc. Nếu vô tình chạm phải, hãy xối nước để rửa. Nếu dung dịch vào mắt, cần thêm sự hỗ trợ của y tế.** Dung dịch tiết ra từ pin có thể gây ngứa hay bỏng.

#### Bảo dưỡng

- ▶ **Đưa dụng cụ điện cầm tay của bạn đến thợ chuyên môn để bảo dưỡng, chỉ sử dụng phụ tùng đúng chủng loại để thay.** Điều này sẽ đảm bảo sự an toàn của máy được giữ nguyên.

#### Cảnh Báo An Toàn cho Máy Khoan và Bắt Vít

- ▶ **Hãy mang dụng cụ bảo vệ tai khi khoan với chế độ đập.** Phơi nhiễm tiếng ồn có thể làm cho tai bị điếc.
- ▶ **Hãy sử dụng tay nắm phụ, nếu như được giao kèm với dụng cụ.** Sự mất điều khiển có thể gây thương tích cho bản thân.
- ▶ **Nắm dụng cụ điện nơi bề mặt nắm cách điện, khi vận hành ở nơi mà phụ tùng cắt hay các chi tiết lắp ráp có thể chạm vào dây điện được bắt đầu dây.** phụ tùng cắt hay các chi tiết lắp ráp chạm vào dây "có điện" làm các bộ phận kim loại phô trần của dụng cụ điện "có điện" và có thể làm cho người vận hành bị điện giật.

## 30 | Tiếng Việt

- ▶ **Sử dụng thiết bị dò tìm thích hợp để xác định các đường hay ống dẫn công ích nằm âm trong khu vực làm việc hay liên hệ với cty công trình phúc lợi để nhờ giúp đỡ.** Tiếp xúc với dây điện có thể dẫn đến cháy và bị điện giật. Chạm đường dẫn khí đốt có thể gây nổ. Làm thủng ống dẫn nước có thể làm hư hại tài sản hay có thể gây ra điện giật.
- ▶ **Tắt máy ngay lập tức khi dụng cụ lắp vào máy đột nhiên bị nghẽn chặt. Để phòng lực vận mạnh có thể được tạo ra do sự giật ngược.**  
Dụng cụ lắp vào có thể bị nghẽn chặt khi:
  - dụng cụ điện cầm tay bị quá tải hay
  - bị chèn chặt trong vật gia công.
- ▶ **Giữ máy bằng cách nắm thật chặt.** Lực vận ngược mạnh có thể xảy ra chớp nhoáng trong lúc bắt vít vào hay vận ra.
- ▶ **Kẹp chặt vật gia công.** Vật gia công được kẹp bằng một thiết bị kẹp hay bằng êtô thì vững chắc hơn giữ bằng tay.
- ▶ **Luôn luôn đợi cho máy hoàn toàn ngừng hẳn trước khi đặt xuống.** Dụng cụ lắp vào máy có thể bị kẹp chặt dẫn đến việc dụng cụ điện cầm tay bị mất điều khiển.
- ▶ **Không được tháo pin ra.** Nguy cơ bị chập mạch.
 

 **Bảo vệ pin không để bị làm nóng, ví dụ, chống để lâu dài dưới ánh nắng gay gắt, lửa, nước, và sự ẩm ướt.** Sự nguy hiểm của nổ.
- ▶ **Trong trường hợp pin bị hỏng hay sử dụng sai cách, hơi nước có thể bốc ra. Hãy làm cho thông thoáng khí và trong trường hợp bị đau phải nhờ y tế chữa trị.** Hơi nước có thể gây ngứa hệ hô hấp.
- ▶ **Chỉ sử dụng pin cùng chung với dụng cụ điện cầm tay Bosch của bạn.** Chỉ riêng với cách này đã bảo vệ cho pin không bị nguy hiểm do quá tải.
- ▶ **Chỉ sử dụng pin chính hãng Bosch có điện thế được ghi trên nhãn máy dụng cụ điện của bạn.** Khi sử dụng các loại pin khác, vd. hàng nhái, pin tân trang hoặc pin của hãng khác, có nguy cơ bị thương tích do pin gây ra cũng như làm hư hỏng tài sản do việc pin bị nổ.

## Các Hướng Dẫn An Toàn và Vận Hành Bổ Sung

- ▶ **Bụi từ các vật liệu như là lớp phủ có chứa chì, một số loại gỗ, khoáng chất và kim loại có thể gây nguy hại đến sức khỏe và gây dị ứng, dẫn đến sự nhiễm trùng đường hô hấp và/hay gây**

**ung thư.** Vật liệu chứa amiăng có thể chỉ nên để cho các thợ chuyên môn gia công.

- Tạo không khí thông thoáng nơi làm việc.
- Khuyến nghị nên mang mặt nạ phòng độc có bộ lọc cấp P2.

Tuân thủ các qui định của quốc gia bạn liên quan đến loại vật liệu gia công.

- ▶ **Tránh không để rác tích tụ tại nơi làm việc.** Rác có thể dễ dàng bắt lửa.
- ▶ **Trước khi làm bất cứ công việc gì với máy (vd. bảo dưỡng, thay dụng cụ v. v..) cũng như trong quá trình vận chuyển và cất giữ, chỉnh đặt gạt chọn chiều quay về vị trí chính giữa.** Sự vô ý kích hoạt công tắc Tắt/Mở có thể dẫn đến thương tích.
- ▶ **Pin được cung cấp đã được nạp điện một phần. Để bảo đảm đầy đủ điện dung, nạp điện hoàn toàn lại cho pin trong bộ nạp điện pin trước khi sử dụng cho lần đầu tiên.**
- ▶ **Hãy đọc hướng dẫn sử dụng bộ nạp điện pin.**
- ▶ **Chỉ được đặt dụng cụ điện cầm tay vào vít khi đã tắt máy.** Dụng cụ đang quay có thể bị tuột ra.
- ▶ **Điều chỉnh gạt chọn lực truyền động chỉ khi máy đã dừng hoàn toàn.**
- ▶ **Nếu gạt chọn lực truyền động không thể đẩy hết sang một bên, xoay mâm cặp khoan một ít.**
- ▶ Bộ chỉ báo kiểm soát sự nạp điện pin bao gồm ba đèn LED màu xanh lá, và báo hiệu tình trạng nạp điện của pin trong một vài giây sau khi công tắc Tắt/Mở được nhấn vào hoàn toàn hay nửa chừng.

LED	Điện dung
Sáng liên tục 3 x màu xanh lá	≥ 2/3
Sáng liên tục 2 x màu xanh lá	≥ 1/3
Sáng liên tục 1 x màu xanh lá	< 1/3
Chớp sáng 1 x màu xanh lá	Sự Dự Phòng

## Các Biểu Tượng

Các biểu tượng sau đây mang ý nghĩa quan trọng để suy diễn và hiểu các hướng dẫn sử dụng. Xin vui lòng lưu ý đến các biểu tượng và ý nghĩa của chúng. Sự hiểu đúng các biểu tượng sẽ giúp bạn sử dụng máy một cách tốt và an toàn hơn.

Biểu Tượng	Ý Nghĩa
	GSB 10,8-2-LI: Kết Hợp Khoan Pin Phạm vi có màu xám: Tay nắm (phần nắm được cách điện)

Biểu Tượng	Ý Nghĩa
	Mã số máy
	Đọc tất cả các cảnh báo an toàn và mọi hướng dẫn
	Trước khi làm bất cứ việc gì với máy, hãy tháo pin ra
	Mang dụng cụ bảo vệ tai
	Chiều chuyển động
	Chiều phản ứng
	Quay Phải/Trái
	Vít
	Khoan không có tác động đập
	Khoan đập
	Tốc độ thấp
	Tốc độ cao
	Mở công tắc
	Để tắt máy
	Bộ Chỉ Báo Nạp Điện Pin
	Điện thế danh định

Biểu Tượng	Ý Nghĩa
$n_0 1$	Tốc độ không tải (số 1)
$n_0 2$	Tốc độ không tải (số 2)
$n_s$	Tần suất đập
M	Lực vận tối đa theo tiêu chuẩn ISO 5393
	Công trình xây gạch
	Kim Loại
	Gỗ
$\emptyset$	Đường kính khoan, tối đa
$\emptyset$	Đường kính vít tối đa
	Phạm vi mâm cặp kẹp được
	Trọng lượng theo Qui trình EPTA-Procedure 01:2014 (chuẩn EPTA 01:2014)
*	tùy vào loại pin lắp đang sử dụng

### Các món được giao

Khoan pin kết hợp.  
Pin, dụng cụ ứng dụng và các phụ kiện khác được trình bày hay mô tả không phải là một phần trong tiêu chuẩn hàng hóa giao kèm.  
Bạn có thể tìm thấy thông tin mô tả tổng quát các phụ kiện trong chương trình phụ kiện của chúng tôi.

### Dành sử dụng cho

Máy được thiết kế dành cho việc bắt hay tháo vít cũng như khoan gỗ, kim loại, đồ gốm và nhựa mũ và sử dụng để khoan đập vào gạch, công trình xây gạch hay đá.

### Thông số kỹ thuật

Tính năng kỹ thuật của máy được liệt kê trong Bảng ở trang 33 của các hướng dẫn sử dụng này.

Xin vui lòng xem kỹ mã số máy trên nhãn máy của bạn. Tên thương mại của từng máy có thể khác nhau.

### Lắp và Vận Hành

Loại công việc	Hình ảnh	Trang
Tháo Pin	<b>1</b>	34
Lắp Pin Vào	<b>2</b>	34
Gài lắp dụng cụ ứng dụng	<b>3</b>	34
Đảo Chiều Quay	<b>4</b>	35

**32 | Tiếng Việt**

Loại công việc	Hình ảnh	Trang
Chỉnh đặc lực xoắn	5	35
Chỉnh Đặt Phương Thức Hoạt Động	6	36
Sự chọn lực Truyền động, Cơ học	7	36
Mở và Tắt	8	37
Kiểm tra tình trạng nạp điện của pin	9	37
Chọn phụ tùng	-	38

**Bảo Dưỡng Và Làm Sạch**

- ▶ Để được an toàn và máy hoạt động đúng chức năng, luôn luôn giữ máy và các khe thông gió được sạch.

**Dịch Vụ Sau Khi Bán và Dịch Vụ Ứng Dụng**

Bộ phận phục vụ hàng sau khi bán của chúng tôi sẽ trả lời các câu hỏi liên quan đến việc bảo trì và sửa chữa các sản phẩm cũng như các phụ tùng thay thế của bạn. Hình ảnh chi tiết và thông tin phụ tùng thay thế có thể tìm hiểu theo địa chỉ dưới đây:

[www.bosch-pt.com](http://www.bosch-pt.com)

Bộ phận dịch vụ ứng dụng Bosch sẽ hân hạnh trả lời các câu hỏi liên quan đến các sản phẩm của chúng tôi và linh kiện của chúng.

Trong mọi thư từ giao dịch và đơn đặt hàng phụ tùng, xin vui lòng luôn viết đủ 10 con số đã được ghi trên nhãn máy.

**Việt Nam**

Công ty Trách Nhiệm Hữu Hạn Robert Bosch  
Việt Nam, PT/SVN  
Tầng 10, 194 Golden Building  
473 Điện Biên Phủ  
Phường 25, Quận Bình Thạnh  
Thành Phố Hồ Chí Minh  
Việt Nam  
Tel.: (08) 6258 3690 Ext 413  
Fax: (08) 6258 3692  
hieu.lagia@vn.bosch.com  
[www.bosch-pt.com](http://www.bosch-pt.com)

**Vận Chuyển**

Pin có chứa lithium-ion là đối tượng phải tuân theo các qui định của Pháp Luật về Hàng Hóa Nguy Hiểm. Người sử dụng có thể vận chuyển pin bằng đường bộ mà không cần có thêm yêu cầu nào khác. Khi được vận chuyển thông qua bên thứ ba (vd. vận chuyển bằng đường hàng không hay đại lý giao nhận), phải tuân theo các yêu cầu đặc biệt về đóng gói và dán nhãn. Để chuẩn bị cho món hàng sẽ được gửi đi, cần tham khảo ý kiến của chuyên gia về vật liệu nguy hiểm.

Chỉ gửi pin đi khi vỏ ngoài không bị hư hỏng. Dán băng keo hay che kín các điểm tiếp xúc để hở và đóng gói pin cách sao cho pin không thể xô dịch khi nằm trong bao bì được.

Cũng xin vui lòng tuân theo qui định chi tiết có thể có của mỗi quốc gia.

**Thải bỏ**

 Máy, pin nạp điện lại được, phụ kiện và bao bì phải được phân loại để tái chế theo hướng thân thiện với môi trường.

Không được vứt bỏ dụng cụ điện, pin/pin nạp điện lại được vào chung với rác sinh hoạt!

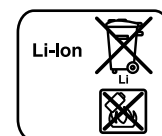





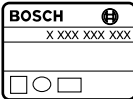

**Pin lốc/pin:****Li-ion:**

Xin vui lòng tuân thủ theo thông tin dưới đây "Vận Chuyển", trang 32.

Được quyền thay đổi nội dung mà không phải thông báo trước.



GSB 10,8-2-LI

		3 601 JB6 9..
U	V=	10,8
$n_0 1$	$\text{min}^{-1}$	0 - 400
$n_0 2$	$\text{min}^{-1}$	0 - 1300
$n_s$	$\text{min}^{-1}$	0 - 19500
M 	Nm	30
M 	Nm	15*
$\emptyset$ 	mm	10
$\emptyset$ 	mm	10
$\emptyset$ 	mm	19
$\emptyset$ 	mm	7
	mm	1 - 10
	kg	1,1 - 1,3

34 |

**1**

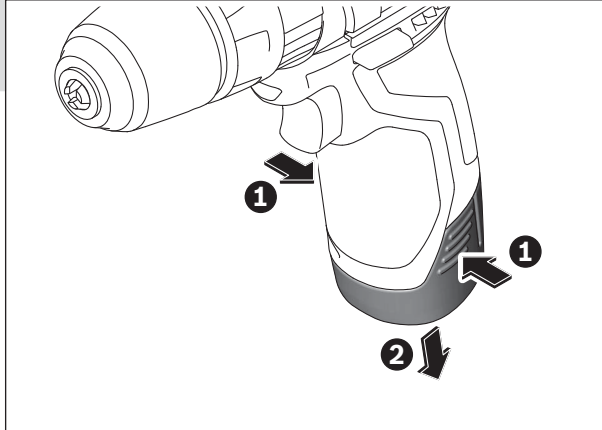
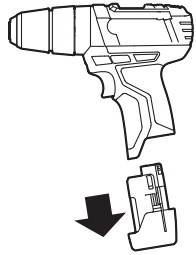

**2**

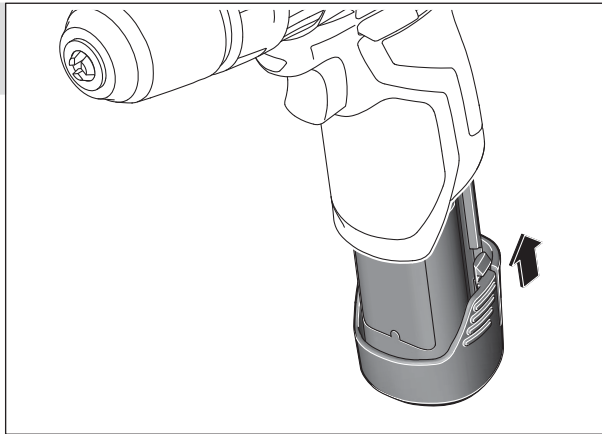
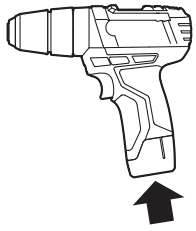

**3**

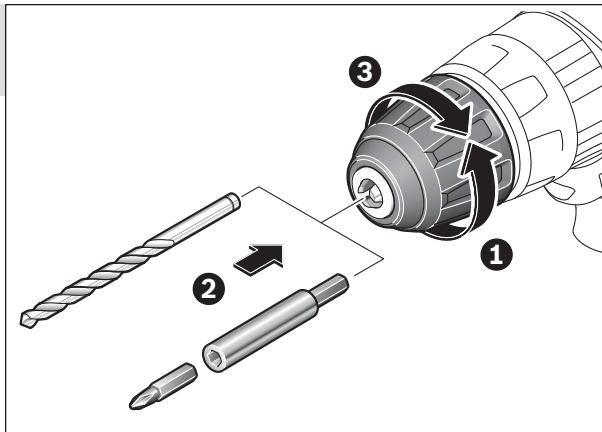
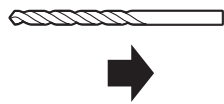

4

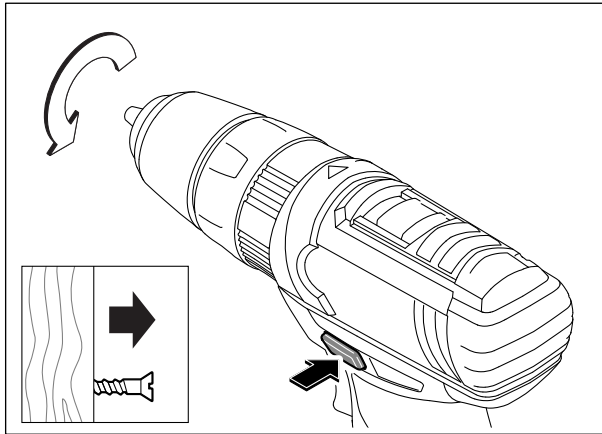
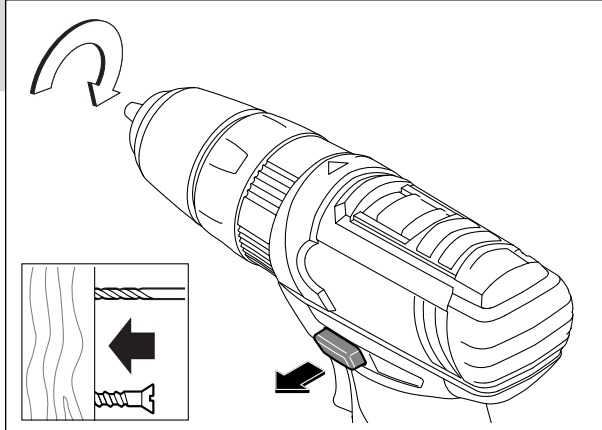
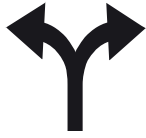

5

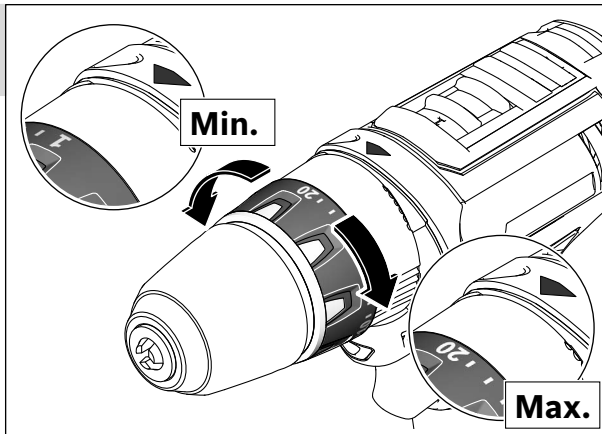

36 |

6

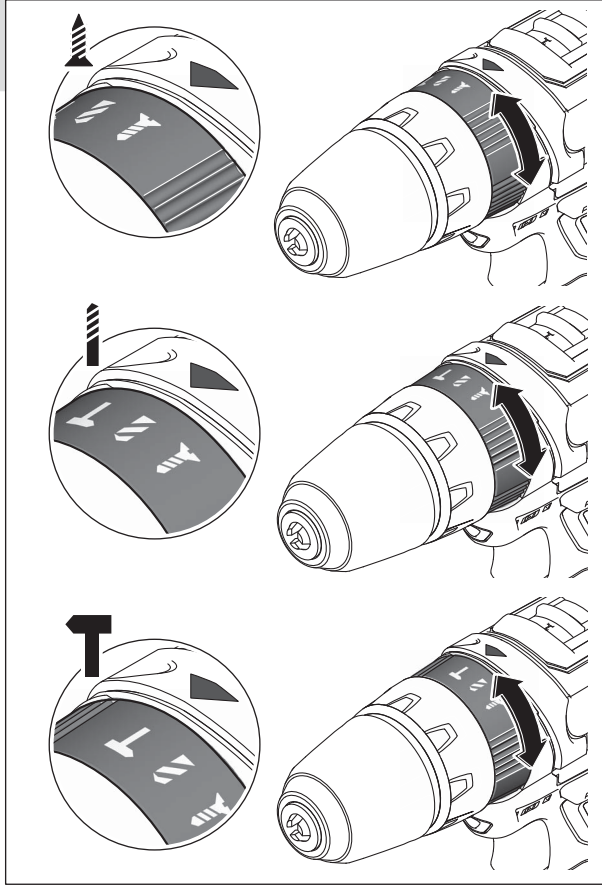

7

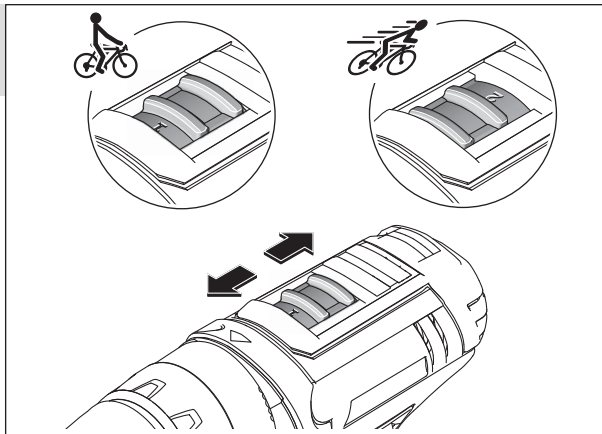
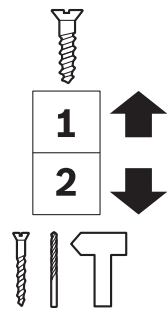

8

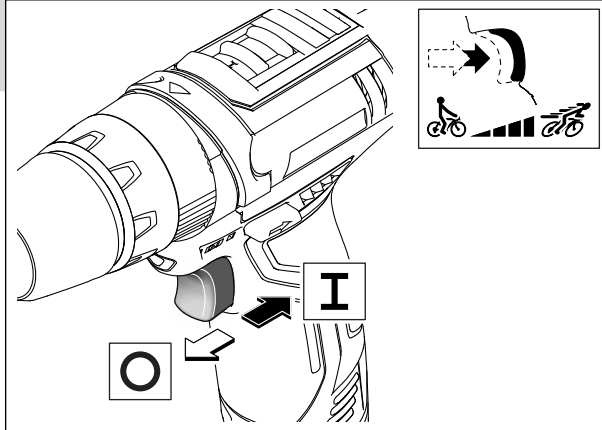

9

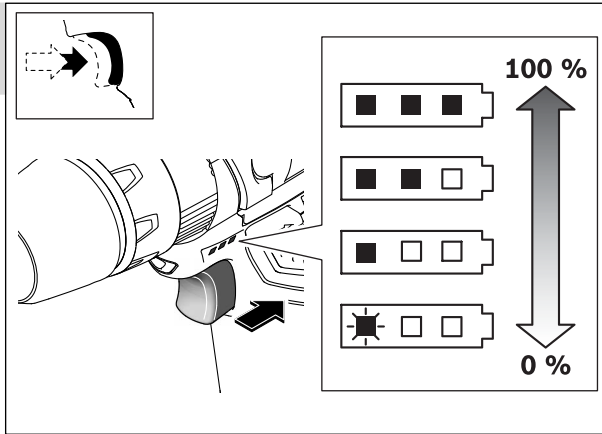
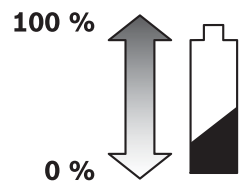

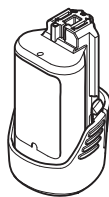

**10,8 V (Li-Ion)**

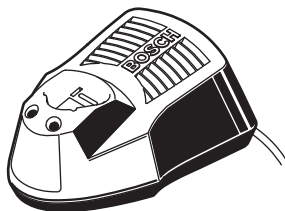

**AL 1130 CV  
(10,8 V)**

1 600 Z00 01P (AU, KO)  
1 600 A00 16N (CN)  
1 600 A00 16P (TW)  
1 600 A00 16R (IN)  
1 600 A00 16S (MY, SG)

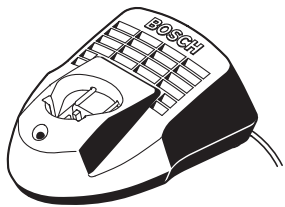

**AL 1115 CV  
(10,8 V)**

2 607 225 518 (AU)  
2 607 225 522 (TW)  
2 607 225 526 (KO)  
2 607 225 530 (CN)