

Guitar / Instrument Cable 6.0mtr RIPP060

YIK122

Instrument / Guitar Cable, O.D. 5.9 mm, 0.22 mm² / AWG 24

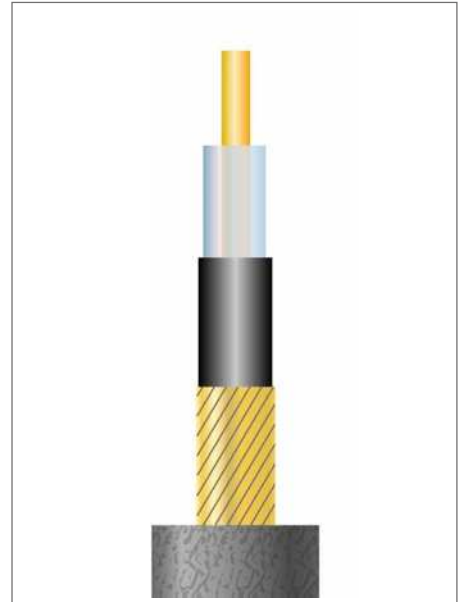
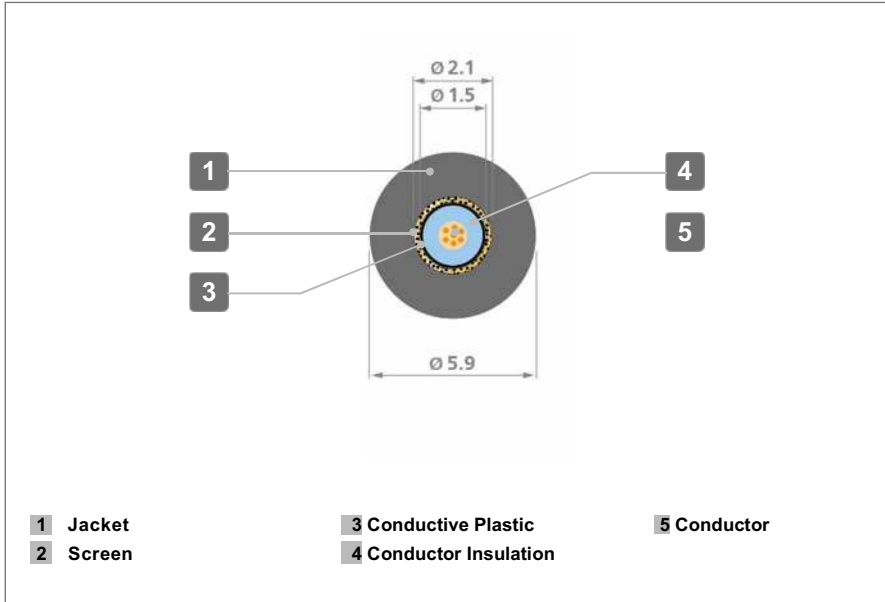

MECHANICAL SPECIFICATION

Composition of conductor	7 x 0.20 mm bare annealed copper, OFC standard
Conductor insulation	LD-PE, Type: DOW 6005 Ø 1.5 mm
Conductor color	transparent
Conductive Plastic Layer	Conductive PVC Ø 2.1 mm
Shield	58 x Ø 0.10 mm Spiral shield, Bare annealed copper, OFC standard, Coverage ≥ 99 %
Overall jacket material	PVC with restricted Substance: Cadmium: < 5 PPM ("Cadmium free") Lead: < 50 PPM Mercury: < 2 PPM Chromium: Not contained
Jacket colour	Black (other colours on request)
Overall diameter	Ø 5.9 mm tolerance: +/- 0.2 mm
Working temperature - Mobile - Fixed	-5°C to +70 °C -20 °C to +70 °C
Cable Printing	- Standard cable print - Customer cable print on request

ELECTRICAL SPECIFICATION

Conductor DC resistance	≤ 80 m [∧] / m – 20 °C
Screen DC resistance	≤ 40 m [∧] / m – 20 °C
Conductive Plastic DC resistance	≤ 3 K [∧] – Distance 20 mm
Insulation resistance	> 1 G [∧] / m – 20 °C, 500 V _{DC}
Capacitance conductor / screen	≤ 140 pF / m – 1 KHz
Test voltage: Conductor / Screen	1.00 VAC – 50 Hz, 1 Minute

1/4" Phone Plugs, 2-pole

Y Series

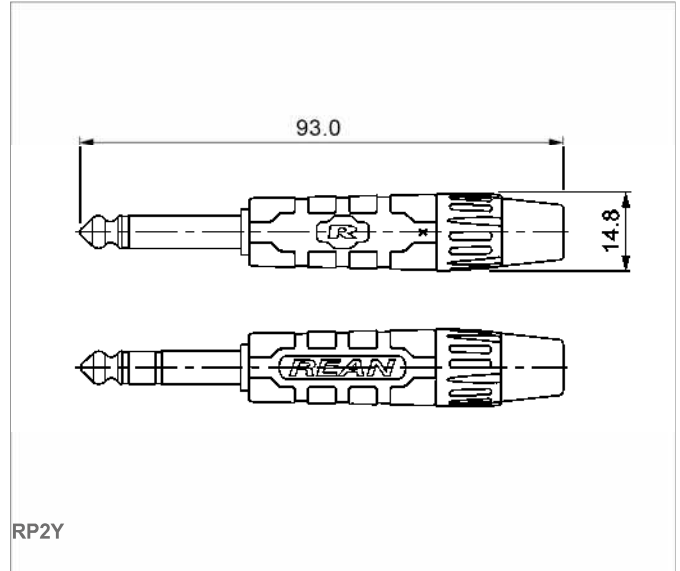

FEATURES

- *Slim and ergonomic design – space saving and convenient to handle*
- *Rugged zinc diecast shell – long lasting and reliable*
- *Chuck type strain relief – best cable retention, easy to assemble*
- *Rubber boot kink protection – guarantees best cable protection and offers long cable life*

CONNECTOR

Type No.	Description
RP2Y	1/4" plug, 2-pole, nickel plated housing and nickel plated plugfinger

REAN[®]

1/4" Phone Plugs

TECHNICAL DATA

ELECTRICAL

Contact resistance	< 10 m Λ
Dielectric strength	> 1 kV dc
Insulation resistance	> 1 G Λ
- initial	
- after damp heat test	> 0.1 G Λ

MECHANICAL

Lifetime	> 1'000 mating cycles
Lateral load capacity	> 4 Nm
Strain relief force	> 70 N
Cable O.D. range	4.0 - 7.0 mm
Wiring type	Soldering
Max. wire size	1 mm ² / AWG 18

MATERIAL

Shell (housing)	Zinc diecast
Shell plating	Nickel
Insert	Nylon
Contacts	Brass
Contact plating	Ni
Strain relief (chuck)	POM
Bushing	Nylon
Boot	PVC

ENVIRONMENTAL

Operating temperature	-20 °C to +70 °C
Solderability	Complies with IEC 68-2-20

Data subject to change without prior notice. © 2017 REAN® is a registered trademark of the Nedrick Group. ALL RIGHTS RESERVED.

REAN®