

61187-1 ✓ ACTIVE

FASTON | FASTON 250

TE Internal #: 61187-1

FASTON 250, Quick Disconnects, Receptacle, 12 – 10AWG Wire Size, 3.31 – 5.26mm² Wire Size, Quick Disconnect Mating Tab

Width 6.35 mm [.25 in]

[View on TE.com >](#)



Terminals & Splices > Quick Disconnects



Terminal & Splice Type: **Receptacle**

Wire Size: **3.31 – 5.26 mm²**

Quick Disconnect Mating Tab Width: **6.35 mm [.25 in]**

Quick Disconnect Mating Tab Thickness: **.81 mm [.032 in]**

Features

Product Type Features

Wire Stop	No
Wire/Cable Type	Regular Wire
Terminates To	Wire & Cable
Quick Disconnect Insertion Force	Normal
Sealable	No
Insulated	No

Configuration Features

Connection Capacity	Single
---------------------	--------

Body Features

Fully Insulated	No
Quick Disconnect Plating Material	Tin

Contact Features

Terminal Type	Receptacle
Terminal & Splice Type	Receptacle



Quick Disconnect Terminal Orientation	Reversible Flag
Contact Base Material	Phosphor Bronze
Crimp Type	F-Crimp
Barrel Type	Open

Mechanical Attachment

Mating Retention Type	Dimple
Wire Insulation Support	With

Dimensions

Accepts Wire Insulation Diameter Range	3.3 – 4.32 mm [.13 – .17 in]
Overall Length	16.26 mm [.64 in]
Receptacle Terminal Stock Thickness	.46 mm [.018 in]
Wire Size	3.31 – 5.26 mm ²
Quick Disconnect Mating Tab Width	6.35 mm [.25 in]
Quick Disconnect Mating Tab Thickness	.81 mm [.032 in]

Usage Conditions

Insulation Requirement	Uninsulated
Operating Temperature Range	-40 – 110 °C [-40 – 230 °F]

Industry Standards

UL Rating	Listed
-----------	--------

Packaging Features

Packaging Quantity	2500
Quick Disconnect Packaging Method	Strip/Reel

Other

Line	Premier
------	---------

Product Compliance

[For compliance documentation, visit the product page on TE.com>](#)

EU RoHS Directive 2011/65/EU	Compliant
EU ELV Directive 2000/53/EC	Not Yet Reviewed
China RoHS 2 Directive MIIT Order No 32, 2016	No Restricted Materials Above Threshold
EU REACH Regulation (EC) No. 1907/2006	Current ECHA Candidate List: JAN 2021 (211)

Candidate List Declared Against: JAN 2021
(211)

Does not contain REACH SVHC

Halogen Content

Low Halogen - Br, Cl, F, I < 900 ppm per homogenous material. Also BFR/CFR/PVC Free

Solder Process Capability

Not applicable for solder process capability

Product Compliance Disclaimer

This information is provided based on reasonable inquiry of our suppliers and represents our current actual knowledge based on the information they provided. This information is subject to change. The part numbers that TE has identified as EU RoHS compliant have a maximum concentration of 0.1% by weight in homogenous materials for lead, hexavalent chromium, mercury, PBB, PBDE, DBP, BBP, DEHP, DIBP, and 0.01% for cadmium, or qualify for an exemption to these limits as defined in the Annexes of Directive 2011/65/EU (RoHS2). Finished electrical and electronic equipment products will be CE marked as required by Directive 2011/65/EU. Components may not be CE marked. Additionally, the part numbers that TE has identified as EU ELV compliant have a maximum concentration of 0.1% by weight in homogenous materials for lead, hexavalent chromium, and mercury, and 0.01% for cadmium, or qualify for an exemption to these limits as defined in the Annexes of Directive 2000/53/EC (ELV). Regarding the REACH Regulation, the information TE provides on SVHC in articles for this part number is based on the latest European Chemicals Agency (ECHA) 'Guidance on requirements for substances in articles' posted at this URL: <https://echa.europa.eu/guidance-documents/guidance-on-reach>

Compatible Parts





Also in the Series | **FASTON 250**

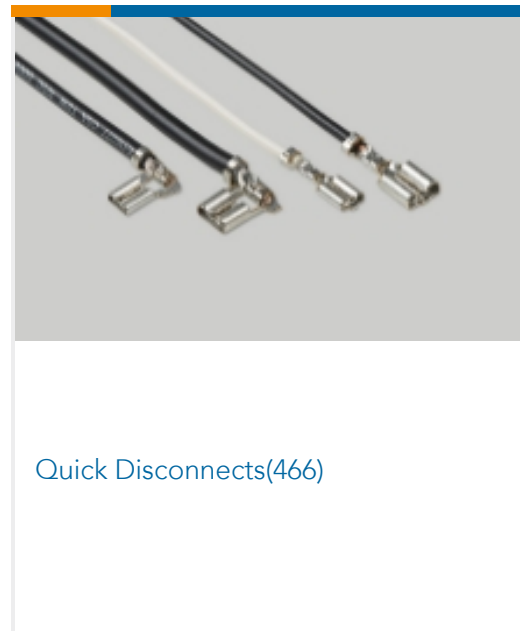
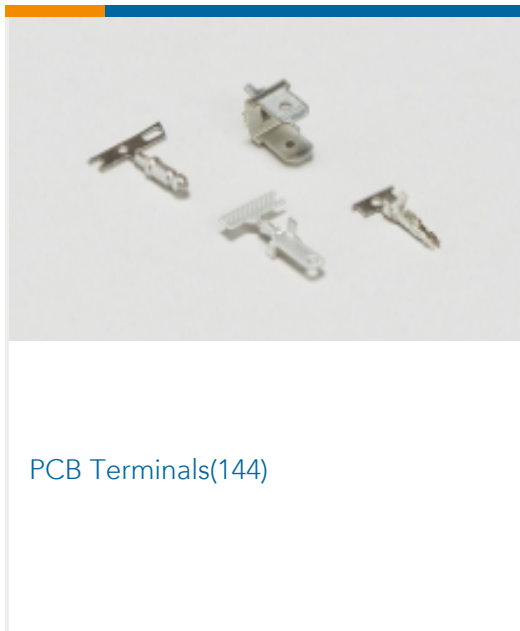
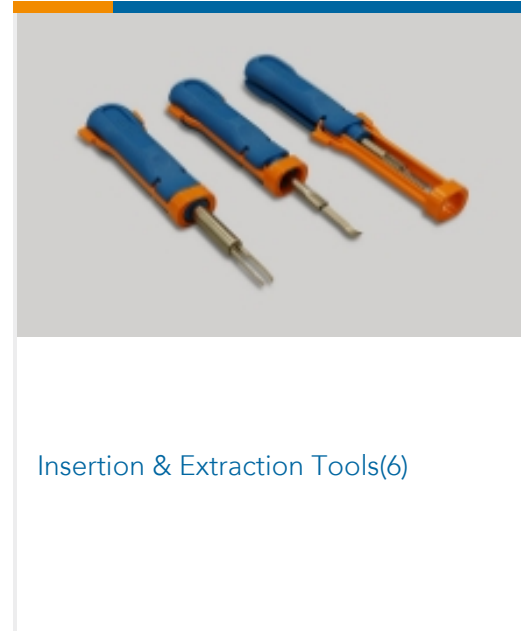
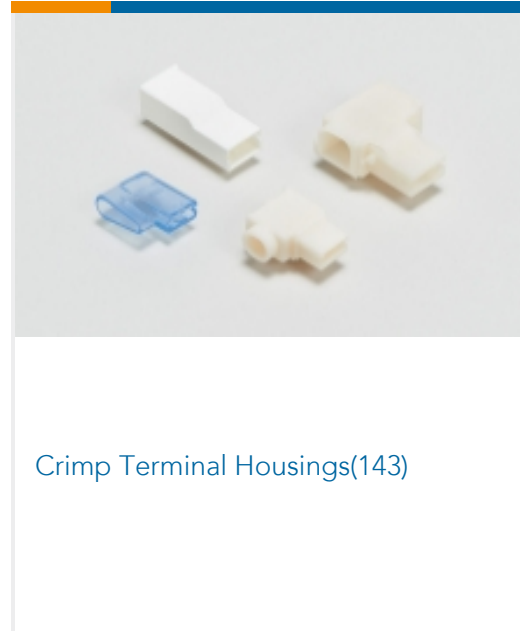
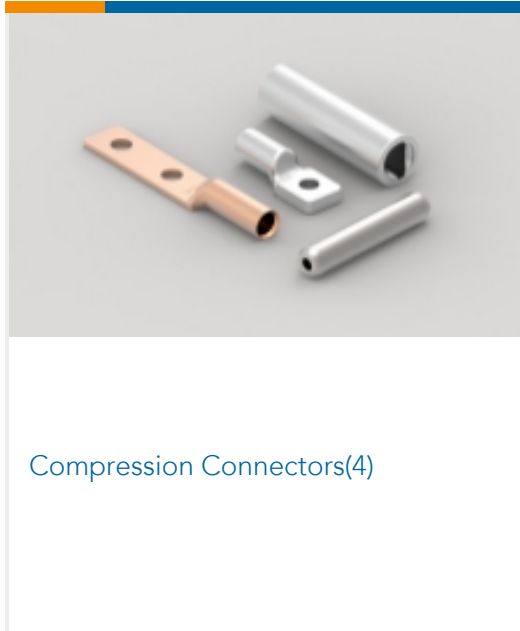

Customers Also Bought

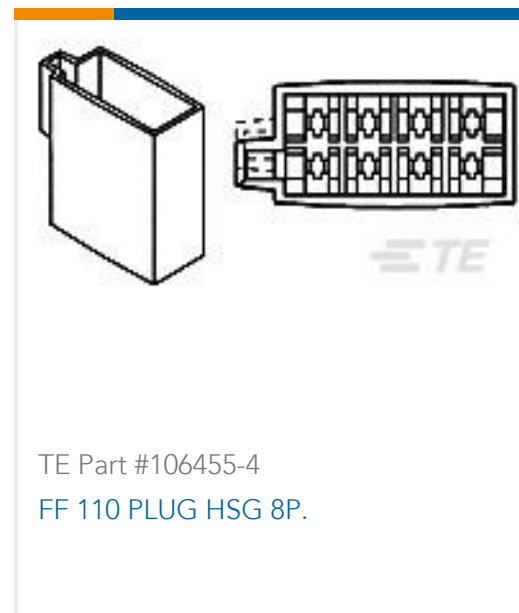
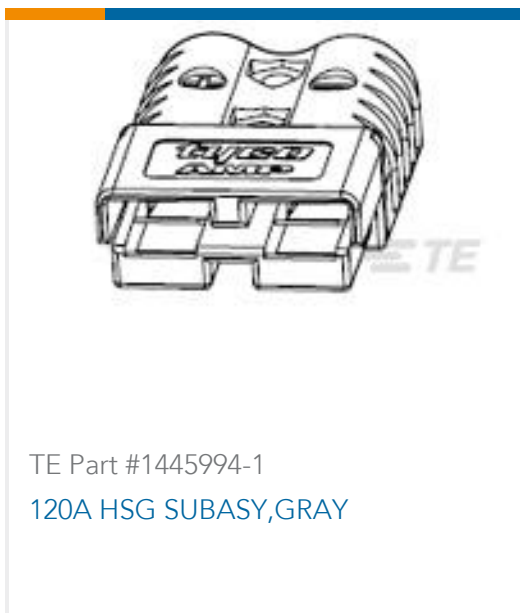



Documents

Product Drawings

[FASTON 250 FLAG REC 12-10 AWG TPHBZ](#)

Japanese

CAD Files

[3D PDF](#)

3D

Customer View Model

[ENG_CVM_CVM_61187-1_P.2d_dxf.zip](#)

English

Customer View Model

[ENG_CVM_CVM_61187-1_P.3d_igs.zip](#)

English

Customer View Model

[ENG_CVM_CVM_61187-1_P.3d_stp.zip](#)

English

By downloading the CAD file I accept and agree to the [Terms and Conditions](#) of use.

Datasheets & Catalog Pages

[82004 FASTON Terminals \(Insulated and Uninsulated\) Catalog - FASTON Receptacles Section](#)

English

Product Specifications

[Application Specification](#)

German

Agency Approvals

[UL Report](#)

English