

Printed-circuit board connector - MSTBA 2,5/ 4-G-5,08 - 1757268

Please be informed that the data shown in this PDF Document is generated from our Online Catalog. Please find the complete data in the user's documentation. Our General Terms of Use for Downloads are valid (<http://phoenixcontact.com/download>)

Header, nominal current: 12 A, rated voltage (III/2): 320 V, number of positions: 4, pitch: 5.08 mm, color: green, contact surface: Tin, mounting: Wave soldering



The figure shows a 10-position version of the product

Why buy this product

- ✓ Maximum flexibility when it comes to device design – one header for connectors with different connection technologies
- ✓ Well-known mounting principle allows worldwide use
- ✓ Plug-in direction parallel to the PCB
- ✓ Closed contour for optimum stability of the plug-in connection

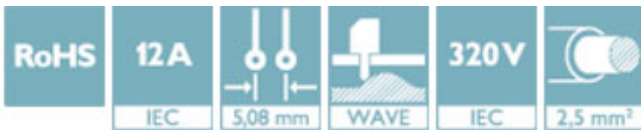

Key Commercial Data

Packing unit	250 STK
GTIN	 4 017918 029791
GTIN	4017918029791
Weight per Piece (excluding packing)	1.500 g
Custom tariff number	85366930
Country of origin	Germany

Technical data

Dimensions

Length [l]	12 mm
Pitch	5.08 mm
Dimension a	15.24 mm
Width [w]	22.24 mm
Constructional height	8.6 mm
Height [h]	12.1 mm
Length of the solder pin	3.5 mm
Pin dimensions	1 x 1 mm

Printed-circuit board connector - MSTBA 2,5/ 4-G-5,08 - 1757268

Technical data

Dimensions

Hole diameter	1.4 mm
---------------	--------

General

Range of articles	MSTBA 2,5/...-G
Insulating material group	I
Rated surge voltage (III/3)	4 kV
Rated surge voltage (III/2)	4 kV
Rated surge voltage (II/2)	4 kV
Rated voltage (III/3)	250 V
Rated voltage (III/2)	320 V
Rated voltage (II/2)	400 V
Connection in acc. with standard	EN-VDE
Nominal current I_N	12 A
Maximum load current	12 A
Insulating material	PA
Flammability rating according to UL 94	V0
Color	green
Number of positions	4

Standards and Regulations

Connection in acc. with standard	EN-VDE
	CSA
Flammability rating according to UL 94	V0

Environmental Product Compliance

China RoHS	Environmentally friendly use period: unlimited = EFUP-e
	No hazardous substances above threshold values

Drawings

Drilling diagram

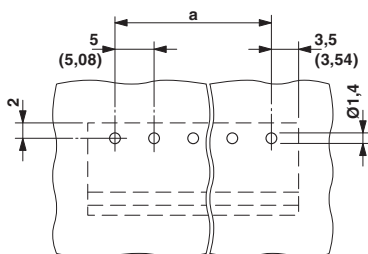

Diagram

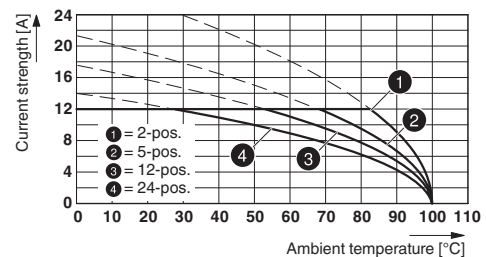

Type: ICV 2,5/...-G-5,08 with MSTBA 2,5/...-G-5,08

Printed-circuit board connector - MSTBA 2,5/ 4-G-5,08 - 1757268

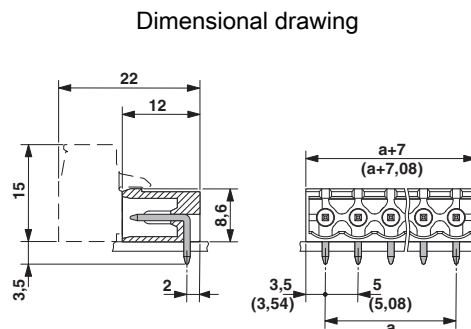
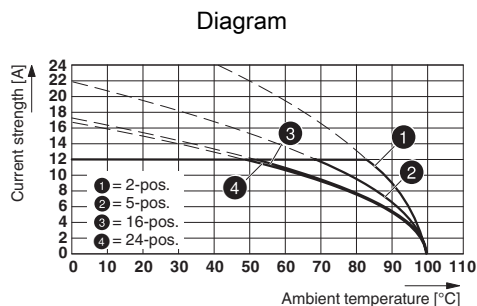

Type: IC 2,5/...-G-5,08 with MSTBA 2,5/...-G-5,08

Classifications

eCl@ss

eCl@ss 4.0	272607xx
eCl@ss 4.1	27260701
eCl@ss 5.0	27260701
eCl@ss 5.1	27260701
eCl@ss 6.0	27260704
eCl@ss 7.0	27440402
eCl@ss 8.0	27440402
eCl@ss 9.0	27440402

ETIM

ETIM 3.0	EC001121
ETIM 4.0	EC002637
ETIM 5.0	EC002637
ETIM 6.0	EC002637

UNSPSC

UNSPSC 6.01	30211810
UNSPSC 7.0901	39121409
UNSPSC 11	39121409
UNSPSC 12.01	39121409
UNSPSC 13.2	39121409

Approvals

Approvals

Approvals

CSA / VDE Gutachten mit Fertigungsüberwachung / IECCE CB Scheme / cULus Recognized / EAC

Ex Approvals

Printed-circuit board connector - MSTBA 2,5/ 4-G-5,08 - 1757268

Approvals

Approval details

CSA		http://www.csagroup.org/services-industries/product-listing/	2585950
		B	D
Nominal current I _N		10 A	10 A
Nominal voltage U _N		300 V	300 V

VDE Gutachten mit Fertigungsüberwachung		http://www.vde.com/en/Institute/OnlineService/ VDE-approved-products/Pages/Online-Search.aspx	40004701
Nominal current I _N		12 A	
Nominal voltage U _N		250 V	

IECEE CB Scheme		http://www.iecee.org/	DE1-58978-B1B2
Nominal current I _N		12 A	
Nominal voltage U _N		250 V	

cULus Recognized		http://database.ul.com/cgi-bin/XYV/template/LISEXT/1FRAME/index.htm	E60425-19931011
		B	D
Nominal current I _N		15 A	10 A
Nominal voltage U _N		300 V	300 V

EAC			B.01742
-----	---	--	---------

Accessories

Accessories

Coding element

Printed-circuit board connector - MSTBA 2,5/ 4-G-5,08 - 1757268

Accessories

Coding star - CR-MSTB - 1734401



Coding section, inserted into the recess in the header or the inverted plug, red insulating material

Filler plug

Accessories - MSTB-BL - 1755477



Keying cap, for forming sections, plugs onto header pin, green insulating material

Labeled terminal marker

Marker card - SK 5,08/3,8:FORTL.ZAHLEN - 0804293



Marker card, Card, white, labeled, Horizontal: consecutive numbers 1 - 10, 11 - 20, etc. up to 91 - (99)100, mounting type: adhesive, for terminal block width: 5.08 mm, lettering field size: 5.08 x 3.8 mm

Marker pen

Marker pen - B-STIFT - 1051993



Marker pen, for manual labeling of unprinted Zack strips, smear-proof and waterproof, line thickness 0.5 mm

Terminal marking

Marker card - SK 5,08/3,8:UNBEDRUCKT - 0805412



Marker card, Card, white, unlabeled, can be labeled with: Marker pen, mounting type: adhesive, for terminal block width: 5.08 mm, lettering field size: 5.08 x 3.8 mm

Printed-circuit board connector - MSTBA 2,5/ 4-G-5,08 - 1757268

Accessories

Additional products

Printed-circuit board connector - TVMSTB 2,5/ 4-ST-5,08 - 1719024



Plug component, nominal current: 12 A, rated voltage (III/2): 400 V, number of positions: 4, pitch: 5.08 mm, connection method: Screw connection with tension sleeve, color: green, contact surface: Tin

Printed-circuit board connector - FKCN 2,5/ 4-ST-5,08 - 1754584



Plug component, nominal current: 12 A, rated voltage (III/2): 320 V, number of positions: 4, pitch: 5.08 mm, connection method: Push-in spring connection, color: green, contact surface: Tin

Printed-circuit board connector - MSTB 2,5/ 4-ST-5,08 - 1757035



Plug component, nominal current: 12 A, rated voltage (III/2): 320 V, number of positions: 4, pitch: 5.08 mm, connection method: Screw connection with tension sleeve, color: green, contact surface: Tin

Printed-circuit board connector - MSTBP 2,5/ 4-ST-5,08 - 1769036



Plug component, nominal current: 12 A, rated voltage (III/2): 320 V, number of positions: 4, pitch: 5.08 mm, connection method: Screw connection with tension sleeve, color: green, contact surface: Tin

Printed-circuit board connector - MSTB 2,5/ 4-STZ-5,08 - 1776155



Plug component, nominal current: 12 A, rated voltage (III/2): 320 V, number of positions: 4, pitch: 5.08 mm, connection method: Screw connection with tension sleeve, color: green, contact surface: Tin

Printed-circuit board connector - MSTBA 2,5/ 4-G-5,08 - 1757268

Accessories

Printed-circuit board connector - FRONT-MSTB 2,5/ 4-ST-5,08 - 1777303

Plug component, nominal current: 12 A, rated voltage (III/2): 320 V, number of positions: 4, pitch: 5.08 mm, connection method: Front screw connection, color: green, contact surface: Tin



Printed-circuit board connector - MSTBT 2,5/ 4-ST-5,08 - 1780002

Plug component, nominal current: 12 A, rated voltage (III/2): 320 V, number of positions: 4, pitch: 5.08 mm, connection method: Screw connection with tension sleeve, color: green, contact surface: Tin



Printed-circuit board connector - MVSTBR 2,5/ 4-ST-5,08 - 1792265

Plug component, nominal current: 12 A, rated voltage (III/2): 320 V, number of positions: 4, pitch: 5.08 mm, connection method: Screw connection with tension sleeve, color: green, contact surface: Tin



Printed-circuit board connector - MVSTBW 2,5/ 4-ST-5,08 - 1792773

Plug component, nominal current: 12 A, rated voltage (III/2): 320 V, number of positions: 4, pitch: 5.08 mm, connection method: Screw connection with tension sleeve, color: green, contact surface: Tin



Printed-circuit board connector - MSTBC 2,5/ 4-ST-5,08 - 1808832

Plug component, nominal current: 12 A, rated voltage (III/2): 320 V, number of positions: 4, pitch: 5.08 mm, connection method: Crimp connection, color: green, Corresponding female crimp contacts with current [A] and conductor cross section range [mm²] data: 10A/MSTBC-MT 0,5-1,0 (3190564); 10A/MSTBC-MT 0,5-1,0 BA (3190645); 12A/MSTBC-MT 1,5-2,5 (3190551); 12A/MSTBC-MT 1,5-2,5 BA (3190658). BA = Bandkontakte



Printed-circuit board connector - MSTBA 2,5/ 4-G-5,08 - 1757268

Accessories

Printed-circuit board connector - MSTBC 2,5/ 4-STZ-5,08 - 1809527



Plug component, nominal current: 12 A, rated voltage (III/2): 320 V, number of positions: 4, pitch: 5.08 mm, connection method: Crimp connection, color: green, Corresponding female crimp contacts with current [A] and conductor cross section range [mm²] data: 10A/MSTBC-MT 0,5-1,0 (3190564); 10A/MSTBC-MT 0,5-1,0 BA (3190645); 12A/MSTBC-MT 1,5-2,5 (3190551); 12A/MSTBC-MT 1,5-2,5 BA (3190658). BA = Bandkontakte

Printed-circuit board connector - MSTBU 2,5/ 4-STD-5,08 - 1824146



Plug component, nominal current: 12 A, rated voltage (III/2): 320 V, number of positions: 4, pitch: 5.08 mm, connection method: Screw connection with tension sleeve, color: green, contact surface: Tin, mounting: Direct mounting

Printed-circuit board connector - MSTBU 2,5/ 4-ST-5,08-FL - 1824379



Plug component, nominal current: 12 A, rated voltage (III/2): 320 V, number of positions: 4, pitch: 5.08 mm, connection method: Screw connection with tension sleeve, color: green, contact surface: Tin, mounting: Direct mounting

Printed-circuit board connector - SMSTB 2,5/ 4-ST-5,08 - 1826306



Plug component, nominal current: 12 A, rated voltage (III/2): 320 V, number of positions: 4, pitch: 5.08 mm, connection method: Screw connection with tension sleeve, color: green, contact surface: Tin

Printed-circuit board connector - TMSTBP 2,5/ 4-ST-5,08 - 1853036



Plug component, nominal current: 12 A, rated voltage (III/2): 320 V, number of positions: 4, pitch: 5.08 mm, connection method: Screw connection with tension sleeve, color: green, contact surface: Tin, The plug allows conductors to be looped through from module to module.

Printed-circuit board connector - MSTBA 2,5/ 4-G-5,08 - 1757268

Accessories

Printed-circuit board connector - FKC 2,5/ 4-ST-5,08 - 1873074

Plug component, nominal current: 12 A, rated voltage (III/2): 320 V, number of positions: 4, pitch: 5.08 mm, connection method: Push-in spring connection, color: green, contact surface: Tin



Printed-circuit board connector - FKCVW 2,5/ 4-ST-5,08 - 1873676

Plug component, nominal current: 12 A, rated voltage (III/2): 320 V, number of positions: 4, pitch: 5.08 mm, connection method: Push-in spring connection, color: green, contact surface: Tin



Printed-circuit board connector - FKCVR 2,5/ 4-ST-5,08 - 1873977

Plug component, nominal current: 12 A, rated voltage (III/2): 320 V, number of positions: 4, pitch: 5.08 mm, connection method: Push-in spring connection, color: green, contact surface: Tin



Printed-circuit board connector - QC 1/ 4-ST-5,08 - 1883271

Plug component, nominal current: 10 A, rated voltage (III/2): 630 V, number of positions: 4, pitch: 5.08 mm, connection method: Displacement connection, color: green, contact surface: Tin

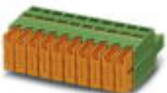

Printed-circuit board connector - FKCT 2,5/ 4-ST-5,08 - 1902136

Plug component, nominal current: 12 A, rated voltage (III/2): 320 V, number of positions: 4, pitch: 5.08 mm, connection method: Push-in spring connection, color: green, contact surface: Tin



Printed-circuit board connector - MSTBA 2,5/ 4-G-5,08 - 1757268

Accessories

Printed-circuit board connector - TFKC 2,5/ 4-ST-5,08 - 1962626

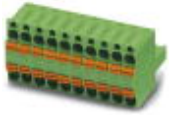

Plug component, nominal current: 12 A, rated voltage (III/2): 320 V, number of positions: 4, pitch: 5.08 mm, connection method: Push-in spring connection, color: green, contact surface: Tin

Printed-circuit board connector - FKCS 2,5/ 4-ST-5,08 - 1975095



Plug component, nominal current: 12 A, rated voltage (III/2): 320 V, number of positions: 4, pitch: 5.08 mm, connection method: Push-in spring connection, color: green, contact surface: Tin
