

Small Signal Diodes

1N4148WS, 1N4448WS, 1N914BWS



ON Semiconductor™

www.onsemi.com

Features

- General Purpose Diodes
- Fast Switching Device ($T_{RR} < 4.0$ ns)
- Very Small and Thin SMD Package
- Moisture Level Sensitivity 1
- Matte Tin (Sn) Lead Finish
- Green Mold Compound
- These Devices are Pb-Free and are RoHS Compliant

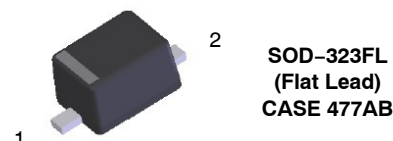

Band Indicates Cathode

ABSOLUTE MAXIMUM RATINGS

Parameter	Symbol	Value	Unit
Non-Repetitive Peak Reverse Voltage	V_{RSM}	100	V
Repetitive Peak Reverse Voltage	V_{RRM}	75	V
Repetitive Peak Forward Current	I_{FRM}	300	mA
Continuous Forward Current	I_O	150	mA
Non-repetitive Peak Forward Surge Current Pulse Width = 1.0 s Pulse Width = 1.0 μ s	I_{FSM}	1.0 4.0	A
Operating Junction Temperature	T_J	+150	$^{\circ}$ C
Storage Temperature Range	T_{STG}	-55 to +150	$^{\circ}$ C

Stresses exceeding those listed in the Maximum Ratings table may damage the device. If any of these limits are exceeded, device functionality should not be assumed, damage may occur and reliability may be affected.

ELECTRICAL SYMBOL

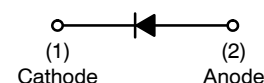

DEVICE MARKING INFORMATION

See general marking information in the device marking section on page 3 of this data sheet.

ORDERING INFORMATION

See detailed ordering and shipping information on page 3 of this data sheet.

THERMAL CHARACTERISTICS (Values are at $T_A = 25^{\circ}$ C unless otherwise noted.)

Symbol	Parameter	Value	Unit
P_D	Power Dissipation ($T_C = 25^{\circ}$ C)	200	mW
$R_{\theta JA}$	Thermal Resistance, Junction-to-Ambient (Note 1)	500	$^{\circ}$ C/W

1. Device mounted on FR-4 PCB minimum land pad.

ELECTRICAL CHARACTERISTICS (Values are at $T_A = 25^{\circ}$ C unless otherwise noted.)

Symbol	Parameter	Conditions	Min	Max	Unit
BV_R	Breakdown Voltage	$I_R = 100 \mu$ A	100	-	V
		$I_R = 5 \mu$ A	75	-	
I_R	Reverse Current	$V_R = 20$ V	-	25	nA
		$V_R = 75$ V	-	5	μ A
V_F	Forward Voltage	1N4448WS / 1N914BWS $I_F = 5$ mA	0.62	0.72	V
		1N4148WS $I_F = 10$ mA	-	1	
		1N4448WS / 1N914BWS $I_F = 100$ mA	-	1	
C_O	Diode Capacitance	$V_R = 0$, $f = 1.0$ MHz	-	4	pF
T_{RR}	Reverse Recovery Time	$I_F = 10$ mA, $I_R = 60$ mA, $I_{RR} = 1$ mA, $R_L = 100 \Omega$	-	4	ns

Product parametric performance is indicated in the Electrical Characteristics for the listed test conditions, unless otherwise noted. Product performance may not be indicated by the Electrical Characteristics if operated under different conditions.

1N4148WS, 1N4448WS, 1N914BWS

TYPICAL CHARACTERISTICS

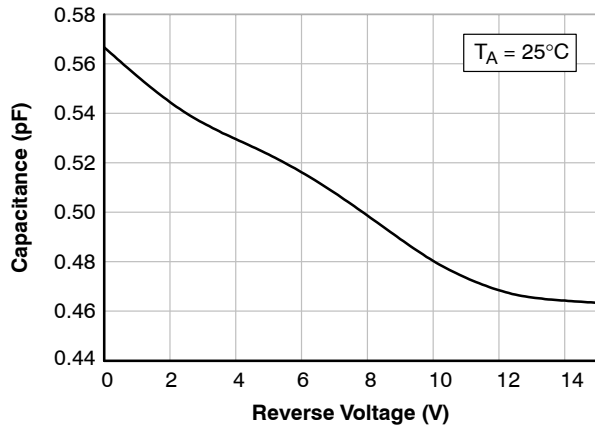

Figure 1. Total Capacitance

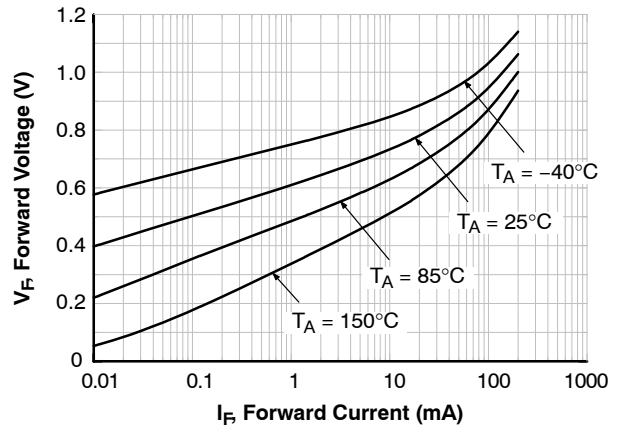

Figure 2. Forward Voltage vs. Ambient Temperature

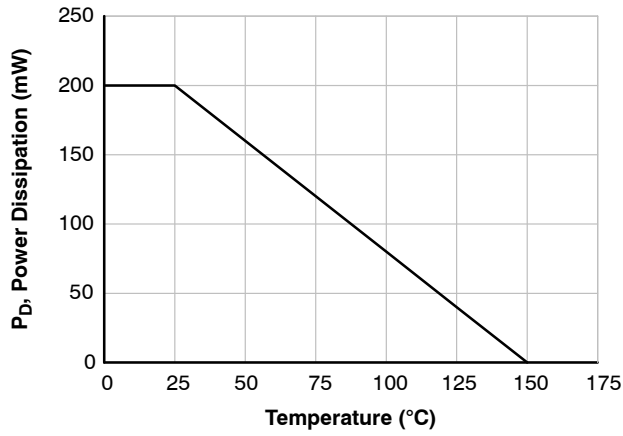

Figure 3. Power Derating Curve

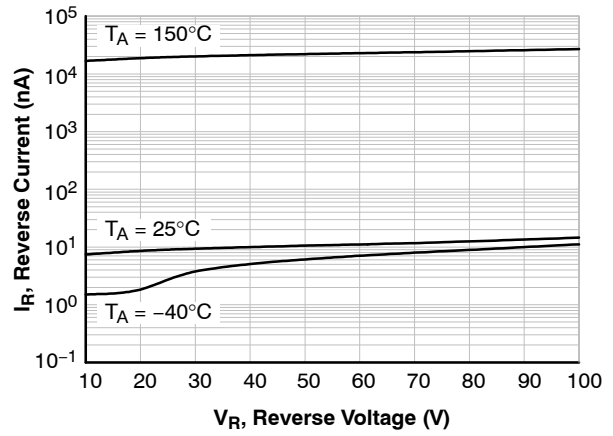

Figure 4. Reverse Current vs. Reverse Voltage

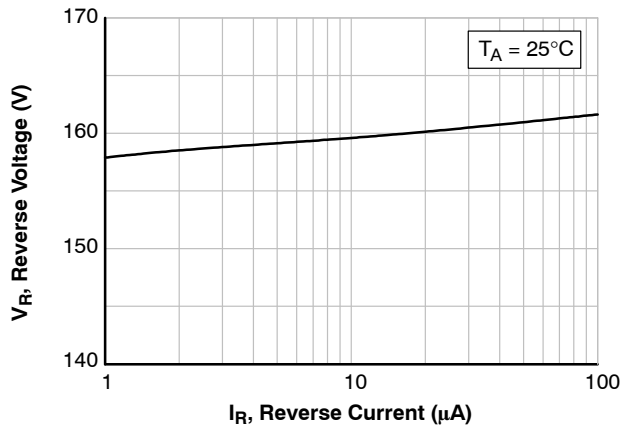
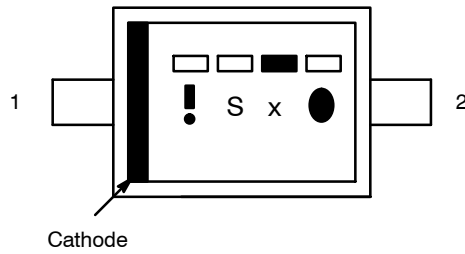

Figure 5. Reverse Voltage vs. Reverse Current

1N4148WS, 1N4448WS, 1N914BWS

MARKING DIAGRAM



- □ □ □ = Calendar Year
- ! = China Subcon
- Sx = Specific Device Code
x = 1, 2, 3
- = Payweek

ORDERING INFORMATION

Part Number	Top Mark	Package	Shipping [†]
1N4148WS	S1	SOD-323FL (Pb-Free)	3000 / Tape & Reel
1N4448WS	S2		
1N914BWS	S3		

[†]For information on tape and reel specifications, including part orientation and tape sizes, please refer to our Tape and Reel Packaging Specifications Brochure, [BRD8011/D](#).

MECHANICAL CASE OUTLINE
PACKAGE DIMENSIONS

SOD-323FL
CASE 477AB
ISSUE O

DATE 30 APR 2012

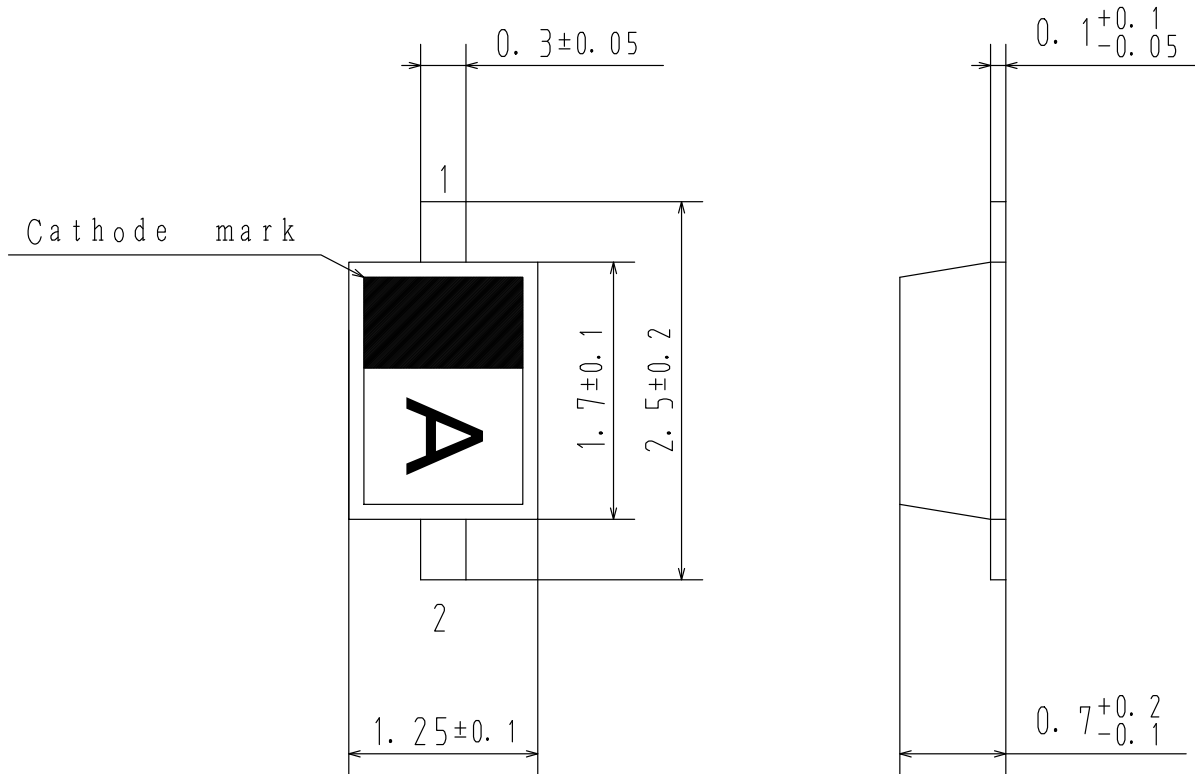

DOCUMENT NUMBER:	98AON79864E	Electronic versions are uncontrolled except when accessed directly from the Document Repository. Printed versions are uncontrolled except when stamped "CONTROLLED COPY" in red.
DESCRIPTION:	SOD-323FL	PAGE 1 OF 1

ON Semiconductor and  are trademarks of Semiconductor Components Industries, LLC dba ON Semiconductor or its subsidiaries in the United States and/or other countries. ON Semiconductor reserves the right to make changes without further notice to any products herein. ON Semiconductor makes no warranty, representation or guarantee regarding the suitability of its products for any particular purpose, nor does ON Semiconductor assume any liability arising out of the application or use of any product or circuit, and specifically disclaims any and all liability, including without limitation special, consequential or incidental damages. ON Semiconductor does not convey any license under its patent rights nor the rights of others.

onsemi, **Onsemi**, and other names, marks, and brands are registered and/or common law trademarks of Semiconductor Components Industries, LLC dba "**onsemi**" or its affiliates and/or subsidiaries in the United States and/or other countries. **onsemi** owns the rights to a number of patents, trademarks, copyrights, trade secrets, and other intellectual property. A listing of **onsemi**'s product/patent coverage may be accessed at www.onsemi.com/site/pdf/Patent-Marking.pdf. **onsemi** reserves the right to make changes at any time to any products or information herein, without notice. The information herein is provided "as-is" and **onsemi** makes no warranty, representation or guarantee regarding the accuracy of the information, product features, availability, functionality, or suitability of its products for any particular purpose, nor does **onsemi** assume any liability arising out of the application or use of any product or circuit, and specifically disclaims any and all liability, including without limitation special, consequential or incidental damages. Buyer is responsible for its products and applications using **onsemi** products, including compliance with all laws, regulations and safety requirements or standards, regardless of any support or applications information provided by **onsemi**. "Typical" parameters which may be provided in **onsemi** data sheets and/or specifications can and do vary in different applications and actual performance may vary over time. All operating parameters, including "Typicals" must be validated for each customer application by customer's technical experts. **onsemi** does not convey any license under any of its intellectual property rights nor the rights of others. **onsemi** products are not designed, intended, or authorized for use as a critical component in life support systems or any FDA Class 3 medical devices or medical devices with a same or similar classification in a foreign jurisdiction or any devices intended for implantation in the human body. Should Buyer purchase or use **onsemi** products for any such unintended or unauthorized application, Buyer shall indemnify and hold **onsemi** and its officers, employees, subsidiaries, affiliates, and distributors harmless against all claims, costs, damages, and expenses, and reasonable attorney fees arising out of, directly or indirectly, any claim of personal injury or death associated with such unintended or unauthorized use, even if such claim alleges that **onsemi** was negligent regarding the design or manufacture of the part. **onsemi** is an Equal Opportunity/Affirmative Action Employer. This literature is subject to all applicable copyright laws and is not for resale in any manner.

PUBLICATION ORDERING INFORMATION

LITERATURE FULFILLMENT:

Email Requests to: orderlit@onsemi.com

onsemi Website: www.onsemi.com

TECHNICAL SUPPORT

North American Technical Support:
Voice Mail: 1 800-282-9855 Toll Free USA/Canada
Phone: 011 421 33 790 2910

Europe, Middle East and Africa Technical Support:

Phone: 00421 33 790 2910

For additional information, please contact your local Sales Representative