

MSUD valve plug form A 18mm with cable

PUR 5x0.75 bk UL/CSA+drag chain 10,5m

Form A (18 mm) for pressure switch
24 V DC with LED (red/green)

Further cable lengths on request. Plastic housings with good resistance against chemicals and oils. The resistance to aggressive media should be individually tested for your application. Further details on request.

[Link to Product](#)

Illustration

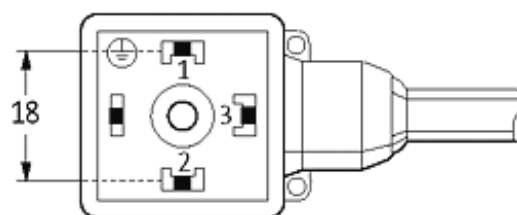
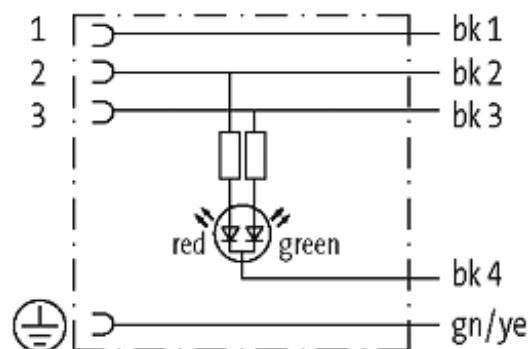



Product may differ from Image

Approvals



Form

18121

Technical Data

Operating voltage	24 V DC $\pm 25\%$
Operating current per contact	max. 4 A
Locking of ports	M3 (recommended torque 0.4 Nm)
Housing	Black plastic (gray on request)
Protection	IP67 inserted and tightened (EN 60529)

Cables

Cable number	638
No./diameter of wires	5 \times 0.75 mm ²
Wire isolation	PP (bk, num, gnye)
C-track properties	5 Mio.
Torsion	2 Mio. \pm 180°/m
Jacket Color	black
Shore hardness outer jacket	90 \pm 5A
Material (jacket)	PUR (UL/CSA)
Outer diameter	approx. 7.0 mm
Bend radius (fixed)	5 \times outer \varnothing
Bend radius (moving)	10 \times outer \varnothing
Temperature range (fixed)	-40...+80 °C
Temperature range (mobile)	-25...+80 °C

Commercial data

country of origin	CZ
customs tariff number	85444290
minimum order quantity	1

