

TIMEGUARD®

Slimline LED Floodlight

Installation & Operating Instructions



Model: LEDPRO10WH (White)
Model: LEDPRO10B (Black)



Model: LEDPRO20WH (White)
Model: LEDPRO20B (Black)



Model: LEDPRO30WH (White)
Model: LEDPRO30B (Black)



Model: LEDPRO50WH (White)
Model: LEDPRO50B (Black)

1. General Information

These instructions should be read carefully and retained for further reference and maintenance.

2. Safety

- Before installation or maintenance, ensure the mains supply to the luminaire is switched off and the circuit supply fuses are removed or the circuit breaker turned off.
- It is recommended that a qualified electrician is consulted or used for the installation of this luminaire and install in accordance with the current IEE wiring and Building Regulations.
- Check that the total load on the circuit including when this luminaire is fitted does not exceed the rating of the circuit cable, fuse or circuit breaker.

3. Technical Specifications

- 230V AC, 50Hz
- These luminaires are of class I construction and must be earthed
- Colour Temperature: 5000K
- Energy Efficiency: class A
- IP65 Rated suitable for restricted external applications
- CE Compliant

LEDPRO10WH & LEDPRO10B

- 10W LED Non replaceable lamp
- Energy Usage: 10Kwh/1000h
- Lumen Output: Black: 650 lm, White: 750lm

LEDPRO20WH & LEDPRO20B

- 20W LED Non replaceable lamp
- Energy Usage: 20Kwh/1000h
- Lumen Output: Black: 1400lm, White: 1500lm

LEDPRO30WH & LEDPRO30B

- 30W LED Non replaceable lamp
- Energy Usage: 30Kwh/1000h
- Lumen Output: Black: 2050lm, White: 2100lm

LEDPRO50WH & LEDPRO50B

- 50W LED Non replaceable lamp
- Energy Usage: 50Kwh/1000h
- Lumen Output: Black: 3500lm, White: 3600lm

4. Installation

- Ensure the mains supply is switched off and the circuit supply fuses are removed or the circuit breaker turned off.
- An isolating switch should be installed to the switch the power ON & OFF to the luminaire. This allows the unit to be easily switched OFF for maintenance purposes.
- Mark the position of the mounting holes on the wall using the U bracket supplied as a template.

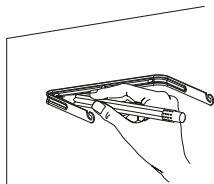

- Drill the holes for the wall plugs ensuring not to infringe with any gas/water pipes or electrical cables that may be hidden below the surface.

Ø 6mm or 7mm

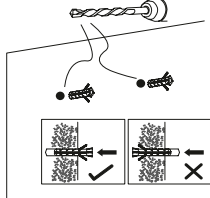

* 10W & 20W use 6mm screw peg

* 30W & 50W use 7mm screw peg

- Fix the U bracket to the wall using the correct screws for the wall plugs installed. Note: Ensure that when you mount this, the slots at the end of the bracket open upwards to allow to you to easily attach and secure the floodlight when ready

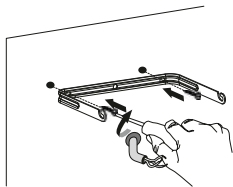

- Secure the supply cable into the junction box through the hole(s) provided ensuring that a cable gland, grommet or sealing compound is used to maintain the IP rating of the luminaire.

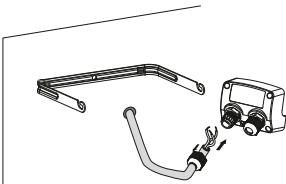

- Attach the strain relief to the luminaire and screw in ensuring not to over-tighten.

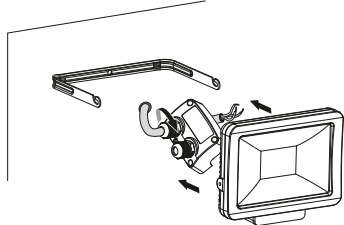

- Attach the luminaire to the U bracket fitted to the wall. You are able to pre-fit the supplied fixing screws and washers to the luminaire before you do this, the screws will just need to be loose enough to fit over the upward facing slots on the end of the U bracket. Make sure the washers are in the correct order as per the diagram. When the luminaire is in place, secure the screws ensuring not over tighten.

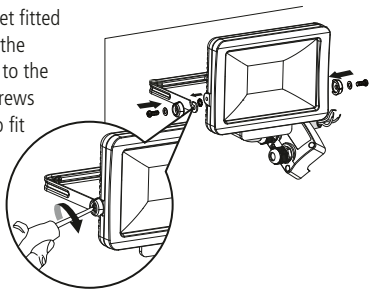

- Terminate the supply cable into the terminal block (please refer to section 5 connection diagram) ensuring correct polarity is observed and that all bare conductors are sleeved.

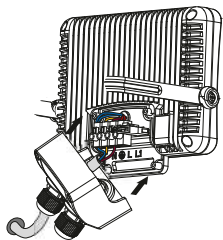

- Attach the supplied wall plate to the luminaire, apply pressure to catches located on top and bottom, then screw in on both sides ensuring not to over-tighten.

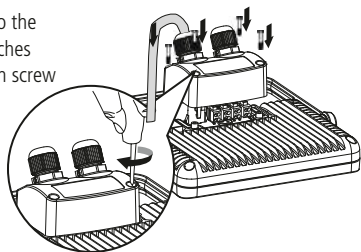

5. Connection Diagram

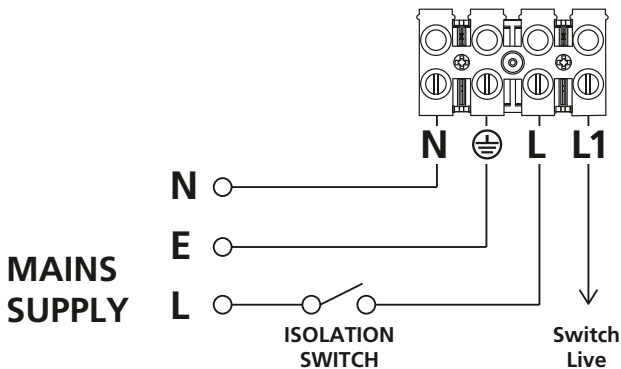

4

Connect the 3 core mains supply cable to the block on the unit as follows:-

LIVE (Brown or Red)	L
NEUTRAL (Blue or Black)	N
EARTH (Green/Yellow)	

Note: the L1 terminal is a Switch Live 'Live Output' for slave floodlights (when used in conjunction with the Timeguard LEDPROSLB/WH PIR or LEDPROPCB/WH Photocell)

6. Operation

- Turn the power on to the isolating switch and test for correct operation.

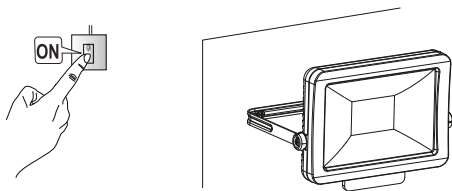

7. Lamp Adjustment

- The lamp can be tilted 360° turn through U-Bracket.

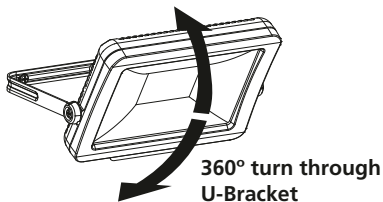

3 Year Guarantee

In the unlikely event of this product becoming faulty due to defective material or manufacture within 3 years of the date of purchase, please return it to your supplier in the first year with proof of purchase and it will be replaced free of charge. For years 2 and 3 or any difficulty in the first year, telephone the helpline on 020 8450 0515.

Note: A proof of purchase is required in all cases. For all eligible replacements (where agreed by Timeguard) the customer is responsible for all shipping/postage charges outside of the UK. All shipping costs are to be paid in advance before a replacement is sent.



If you experience problems, do not immediately return the unit to the store. Telephone the Timeguard Customer Helpline;

HELPLINE

020 8450 0515

or email helpline@timeguard.com

Qualified Customer Support Co-ordinators will be on-line to assist in resolving your query.



A **theben** Group Company

For a product brochure please contact:

Timeguard Limited.

Victory Park, 400 Edgware Road,
London NW2 6ND

Sales Office: 020 8452 1112
or email csc@timeguard.com

www.timeguard.com