

I7R210

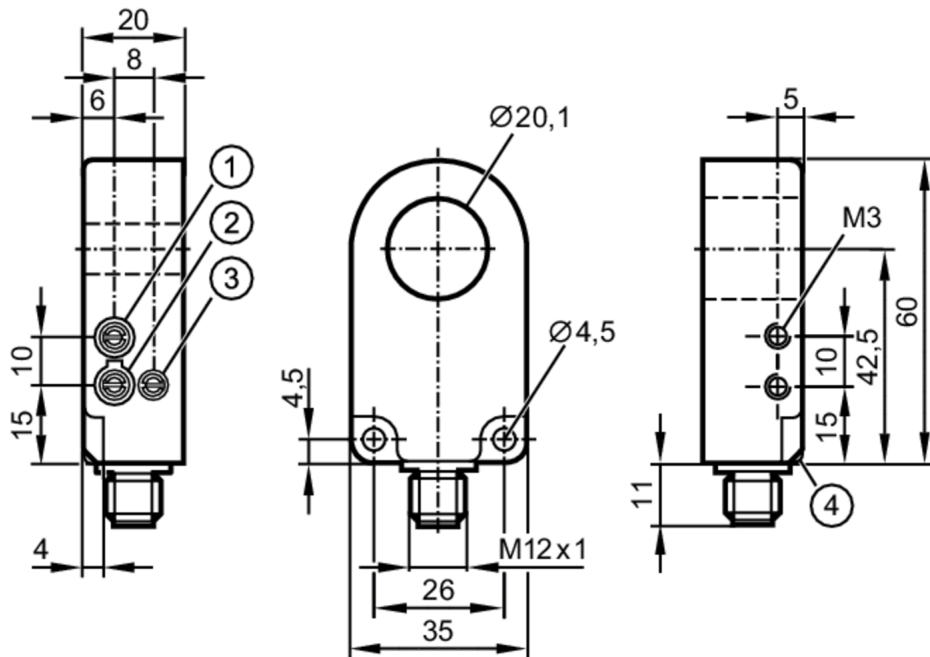

Inductive ring sensor

I7R3020-FNKG/US-100-INF



- 1 sensitivity
- 2 Output function
- 3 pulse stretching time



Product characteristics

Electrical design	NPN
Output function	normally open / normally closed; (selectable)
Housing	circular
Dimensions [mm]	60 x 35 x 20

Application

Operating principle	static
---------------------	--------

Electrical data

Operating voltage [V]	10...35 DC
Current consumption [mA]	< 11
Protection class	III
Reverse polarity protection	yes

Outputs

Electrical design	NPN
Output function	normally open / normally closed; (selectable)
Max. voltage drop switching output DC [V]	2
Permanent current rating of switching output DC [mA]	200
Short-circuit protection	yes
Overload protection	yes

I7R210



Inductive ring sensor

I7R3020-FNKG/US-100-INF

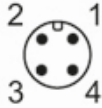
Detection zone		
Resolution of steel ball (diameter)	[mm]	2.5
Max. part speed	[m/s]	35
Response times		
Pulse stretching	[ms]	10...150
Pulse stretching adjustable		yes
Max. fall time	[ms]	10
Response time	[ms]	< 0.5
Operating conditions		
Ambient temperature	[°C]	-25...70
Protection		IP 67
Tests / approvals		
MTTF	[years]	658
UL approval	Ta	-25...70 °C
	Enclosure type	Type 4X (indoor use only) / 12 and 13
	voltage supply	Class 2
	File number UL	E174191
Mechanical data		
Weight	[g]	58.5
Housing		circular
Dimensions	[mm]	60 x 35 x 20
Inside diameter	[mm]	20.1
Materials		housing: PA; ring: POM
Displays / operating elements		
Display	switching status	1 x LED, yellow
Remarks		
Pack quantity		1 pcs.
Electrical connection - plug		
Connector: 1 x M12		
		

I7R210



Inductive ring sensor

I7R3020-FNKG/US-100-INF

Connection

