

# Keysight Technologies

## B2980A Series

### Femto/Picoammeter and Electrometer/High Resistance Meter

#### Data Sheet

The world's only graphical  
Picoammeter/Electrometer  
that can confidently measure  
down to 0.01 fA and up to 10 PΩ



## Product Overview

### Unique capabilities and features maximize confidence for sensitive measurements

Keysight B2980A Series of Femto/Picoammeters and Electrometers/High Resistance Meters not only offer best-in-class measurement performance, but also provide unprecedented features to maximize your measurement confidence. The Femto/Picoammeters and Electrometers both offer 0.01 fA ( $10^{-17}$  A) minimum current resolution, which meets virtually all existing and future low-level current measurement needs. The electrometers feature a 1,000 V voltage sourcing capability that supports up to 10 P $\Omega$  ( $10^{16}$   $\Omega$ ) resistance measurements. The electrometers also work with Keysight's well-proven high resistance meter accessories. Both the Femto/Picoammeter and Electrometer have battery powered versions to eliminate AC power line noise. This available capability provides an unmatched level of noise reduction, enabling low-level measurements that were previously impossible.

Unlike conventional picoammeters and electrometers, the B2980A series possesses a 4.3" color LCD-based graphical user interface (GUI) that provides multiple options for viewing data. In addition to numeric format, data can also be viewed as a graph, as a histogram and as a trend chart. These unique front-panel capabilities facilitate the capture of transient behavior and provide the ability to make quick statistical analyses without the need for a PC. The B2980A series also has features to help you maintain measurement integrity on the external cabling and fixturing. The available Setup Integrity Checker software permits the comparison of noise levels for different cabling and fixturing arrangements, allowing you to identify and isolate the noise-sensitive areas in your measurement system. In addition to these impressive measurement capabilities, the B2980A series has easy-to-use and convenient measurement assist functions that permit users with limited or no electrical engineering training to perform complicated electrical characterization operations with ease.

To provide flexibility and enable you to purchase an instrument with the exact amount of testing capability for your needs, the Keysight B2980A series offers four product versions.



### Key specifications

Model	Femto/Picoammeter		Electrometer/High Resistance Meter	
	B2981A	B2983A	B2985A	B2987A
Measurement resolution	6½ digits	6½ digits	6½ digits	6½ digits
Current measurement	0.01 fA - 20 mA	0.01 fA - 20 mA	0.01 fA - 20 mA	0.01 fA - 20 mA
Minimum range	2 pA	2 pA	2 pA	2 pA
Resistance measurement			Up to 10 P $\Omega$	Up to 10 P $\Omega$
Voltage measurement			1 $\mu$ V - 20 V	1 $\mu$ V - 20 V
Input resistance			> 200 T $\Omega$	> 200 T $\Omega$
Charge measurement			1 fC - 2 $\mu$ C	1 fC - 2 $\mu$ C
Temperature measurement			√	√
Humidity measurement			√	√
Voltage source			Up to $\pm$ 1,000 V	Up to $\pm$ 1,000 V
Minimum resolution			700 $\mu$ V	700 $\mu$ V
Maximum reading rate	20,000 rdg/s	20,000 rdg/s	20,000 rdg/s	20,000 rdg/s
Battery operation		√		√
Other key features	Graphical capability (Meter View, Graph View, Histogram View, Roll View), Auto navigation, 100,000 points sample buffer, Interface (USB, LAN, GPIB, LXI Core), Free PC control software, etc.			

# The World's Only Graphical Picoammeter/Electrometer that can Confidently Measure Down to 0.01 fA and Up to 10 PΩ

0.01 fA digit

**+0.000087 pA**

Best-in-class 2 pA to 20 mA current measurement ranges and internal 1,000 V sourcing capability ensure accurate 0.01 fA and 10 PΩ measurements

Battery operation eliminates AC power line noise from measurements

Time domain view (roll view) enables capture of transient signal effects and selection of desired measurement data

Real-time histogram provides quick statistical analysis of measurement data

Test Setup Integrity Checking function and dedicated accessories ensure maximum measurement accuracy

## B2980A Series Key Features

- 0.01 fA ( $10^{-17}$  A) minimum measurement resolution and 2 pA to 20 mA current
- measurement ranges with 6.5 digits resolution
- < 20  $\mu$ V burden voltage in its lowest current range
- High speed reading rate up to 20,000 rdg/s
- Battery operation models for line noise free measurements<sup>1</sup>
- Built-in  $\pm$  1,000 V voltage source<sup>2</sup>
- Measurement resistances up to 10 PΩ ( $10^{16}$  Ω)<sup>2</sup>
- > 200 TΩ input impedance for up to 20 V voltage measurement<sup>2</sup>
- Independent current and voltage measurement<sup>2</sup>
- Charge measurement down to 2 nC range with 6.5 digits resolution<sup>2</sup>
- Temperature and humidity measurements<sup>2</sup>
- Graphical viewing modes (Meter, Graph, Histogram and Roll View)
- Easy-to-use auto navigation to select optimal range and aperture
- Optional Test Setup Integrity Checker function for noise source isolation
- Versatile interface (USB 2.0: LAN, GPIB, LXI Core)
- USB (front): store data, save/recall setup information
- Free PC control software

1. B2983A and B2987A  
 2. B2985A and B2987A

## Application Examples

- Material science (Biomaterials, ceramics, elastomers, films, dielectric materials, electrochemical, ferroelectric materials, graphene, metals, organic materials, nano-materials, polymers, semiconductors, etc.)
- Devices & electronic components (capacitors, resistors, diodes, sensors, transistors including TFT and CNT, optoelectronics, solar cells, etc.)
- Electronic/non-electronic systems (ion beam, electron beam, sensing systems, particle measurements, embedded precision instruments, etc.)

### Why is 0.01 fA resolution important?

Many materials science and device characterization applications require the ability to measure very small currents that conventional DMMs (digital multi-meters) cannot handle. Since the B2980A series provides a best-in-class 0.01 fA current measurement resolution in both its Femto/Picoammeter and Electro-meter versions, it can perform precise and detailed measurements that were previously impossible using conventional picoammeters and electrometers. Therefore, you are assured that your current measurement requirements will be met well into the future.

Typical current measurement ranges

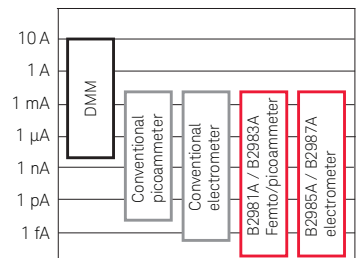

## The B2980A series' unmatched 0.01 fA resolution combines with other unique features to solve previously intractable measurement challenges

Challenge 1: Instruments that only have numeric displays do not give you any control over when to take data during a transient response.

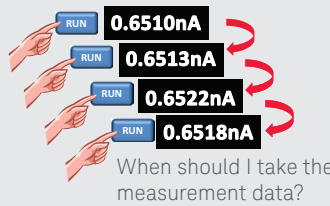

### Solution 1. The B2980A series' time domain view (Roll View) lets you visually choose when to capture data.

The B2980A series' GUI provides a Roll View that can graphically display data as it is taken and that also can store up to 100,000 of these data points for later retrieval. With a sampling rate of up to 100 kHz, the Roll View can reveal real-time measurement trends and provide valuable insights into the dynamics of your DUT's behavior. To facilitate this data analysis, the B2980A series provides flexible graphing capabilities. In Graph View the electrometers can plot I-V curves on their displays using values from either the internal voltage source or voltage measurement data. In addition, it is easy to generate a variety of other X-Y plots such as I-t, V-t, R-t, Q-t, I-R, etc. (specific graphical display capabilities depend on product model). These powerful and versatile graphical capabilities allow you to gain valuable insights when making sensitive measurements.

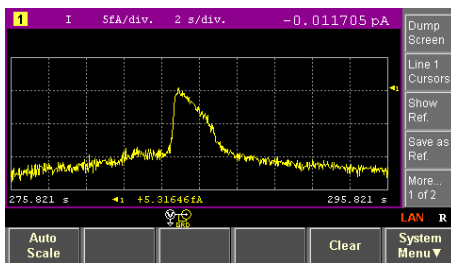

Time domain view (Roll View)

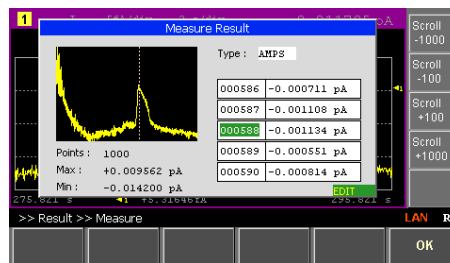

Data recorded up to 100,000 points

Challenge 2: Instruments with only numeric displays often exhibit instability in their least significant digits and offer no information about the measurement's mean and standard deviation.



How does the measurement result distribute?

### Solution 2. You can instantly view and evaluate data distributions using the real-time histogram feature

All low-level measurements carry with them a degree of statistical uncertainty due to inherent fluctuations in the measurement environment. The conventional method to deal with this issue involves post-measurement evaluation of the data (usually on a PC) using a histogram. However, this process can become tedious if you need to perform several measurement and test setup debug cycles.

### How fast can the B2980A series capture data?

Measurement speed is usually determined by the aperture time of the integration setting, which is typically proportional to some number of power line cycles (PLCs). Smaller aperture times are obviously more desirable as long as they provide sufficient averaging to prevent power line noise from affecting the measurement.

However, conventional instruments often cannot capture fast transients due to their relatively slow reading rates that require long overhead after the aperture closes. In contrast, the B2980A series' fast reading rate (20,000 rdg/s) and streamlined system architecture greatly reduce overhead time. As a result the B2980A series does not lose data sampling capability even in its minimum PLC setting, allowing it to capture more detailed DUT responses. The example below compares the data sampling capability of a conventional instrument with that of the B2980A series. As this example shows, the B2980A series can capture data with x4 better timing resolution due to its low measurement overhead.

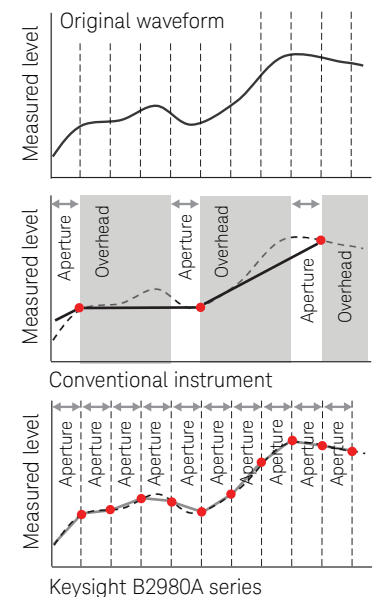

In contrast the B2980A's real-time and auto-scalable histogram display capability continuously updates the mean and sigma, enabling you to debug your measurement setup instantly without the need for any post-measurement data crunching. The histogram can be displayed in the Meter View, allowing you to compare accumulated data on the histogram with real-time numeric data. Note: The maximum number of data points supported by the histogram is 100,000.

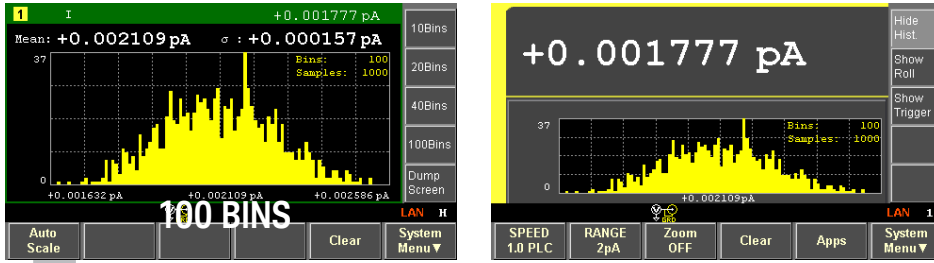

Histogram View

On Meter View

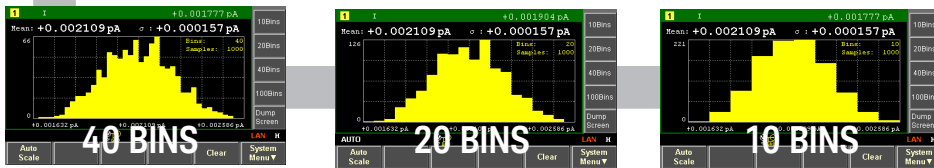

Available BINS: 10, 20, 40 and 100

Challenge 3: Eliminating noise from low-level measurements is difficult and often requires extensive measurement expertise.

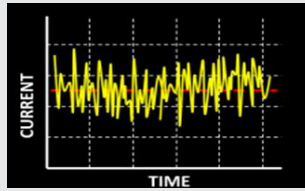

### Solution 3. The B2980A series' battery operated models eliminate power line noise and enhance low noise measurement performance.

AC power line noise strongly impacts sensitive measurements. While integrating over one or more PLCs can minimize AC power line noise effects, even the B2980A's excellent noise performance cannot eliminate 100% of this noise unless the instrument is completely isolated. Therefore, both the Femto/Picoammeter and Electrometer have available battery operated versions that enable you to make power-line-noise-free measurements. The two battery models can function for 7 hours (B2983A) or 5 hours (B2987A) under normal operating conditions, and they also automatically save your measured data and measurement setup information if the battery level goes below 5%. Of course, besides eliminating noise the battery models provide the added benefit of portability allowing you to use them anywhere you want.

Automatic data saving when battery < 5% & shutdown

Automatic data recovery when operation resumed

The battery is automatically charged when connected to AC power

### How much lower is the B2980A series' noise floor?

Even when operating in AC mode with 0.1 PLC integration time, the B2980A series' advanced design provides current measurement performance that is much better than conventional picoammeters and electrometers. The graph shown below compares current measurement noise levels under identical measurement conditions. As can be seen the B2980A series can make both lower noise and faster measurements, which reduces the trade-offs that normally need to be made between these two goals.

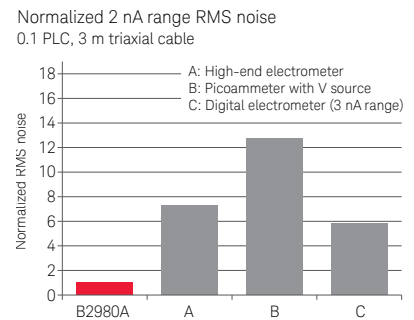

### What makes Keysight triaxial cables superior?

Triaxial cables, which are available from a variety of sources, are required for low-current measurement applications. Keysight triaxial cables employ a semiconductor layer between the insulator and inner jacket, which minimizes the triboelectricity generated by friction at these boundaries. The net result is that Keysight triaxial cables are largely unaffected by cable vibration, which enables more accurate and stable measurements. All B2980A products come with a 1.5 meter version of this triaxial cable.

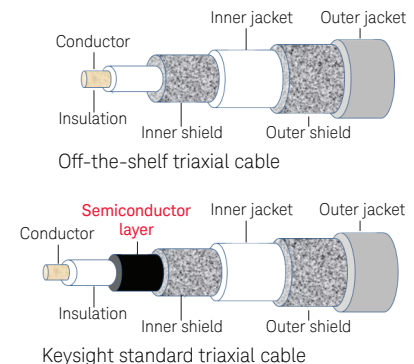

Challenge 4: Verifying the integrity of measurement cabling is essential for accurate measurements, but conventional instruments do not offer any means to validate cable performance.



### Solution 4. Optional software and dedicated accessories help mitigate cabling complexities

When performing sensitive measurements making appropriate cabling connections is often one of the more difficult challenges. Many factors can contribute to measurement noise or instability, including incorrect cabling, poor cable quality and improper guarding; however, determining the root cause of a measurement fixturing issue from among all of these factors is not easy. Conventional instruments do not provide any help to solve these types of issues and they typically only offer written guidance on best practices. In contrast, the B2980A series has an available Setup Integrity Checker function that can identify noise caused by external elements (cables, adapters, shields, chambers, etc.) and display the information in tabular format on the front-panel GUI. As shown below, the setup integrity checker function allows you to compare the noise level of the instrument with no cables connected against the noise level with different setup elements connected. By comparing the noise level standard deviation of different setup elements side by side, you can easily determine the quality of cables and other setup elements necessary for your measurements.

The B2980A series also has specialized accessories available to facilitate certain types of measurements. For example, the N1413A High Resistance Meter Fixture Adapter allows you to use the B2980A series with Keysight's accessories for high resistance measurement (such as the 16008B Resistivity Cell). A High Resistance Measurement Universal Adapter (N1414A) is also available to simplify the cabling for high resistance measurements.

Example showing how to use the Setup Integrity Checker

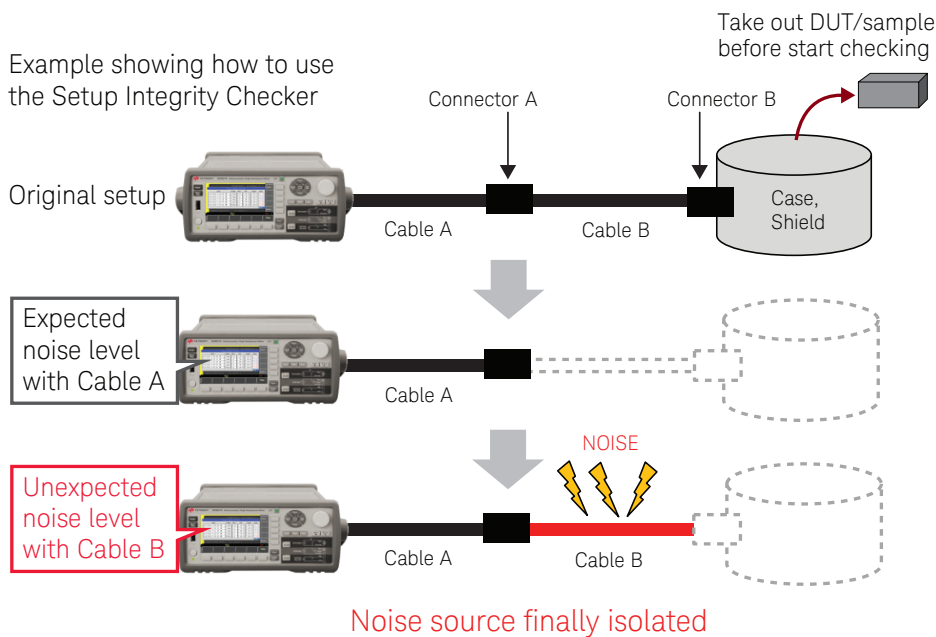

### How much faster is the B2980A series' settling time?

When comparing instrument settling times, you need to understand how each instrument defines this specification. Most conventional instruments define settling time as the time it takes to reach 10% of the final value, whereas the B2980A series uses a value of 0.1%. By reducing dielectric absorption (DA), the B2980A achieves a faster settling time using the 0.1% limit even in its lower measurement ranges as shown below.

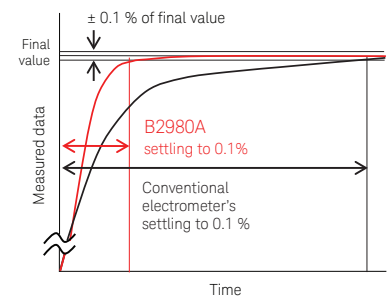

20 pA range settling time  
2 V step, 100 GΩ, 1 PLC

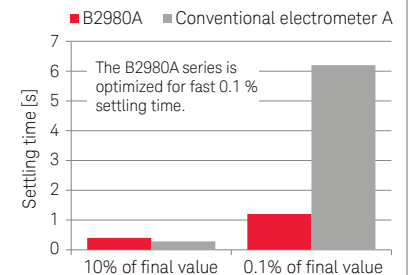

## Innovative measurement functions enable both novice and experienced users to utilize all of the B2980A series' powerful measurement capabilities

### Measurement assist functions reduce low-level measurement challenges

Selecting the appropriate range and aperture time for low-level measurements is not always straightforward, since these settings are affected by both target device or sample characteristics and measurement conditions (noise, temperature, humidity, etc.). For these reasons, selecting the optimal test settings can be challenging for even experienced users. However, the B2980A series has a variety of assist functions to improve your measurement productivity.

The navigation keys enable you to easily find the optimal measurement range and aperture time (speed) parameters. The column at the right shows how the navigation keys work.



Pressing the Home key automatically sets the most appropriate range and speed at any time

Current measurement	Voltage measurement	Resistance measurement	Charge measurement
20 mA	20 V	1 PΩ	2 μC
2 mA	2 V	100 TΩ	200 nC
200 μA		10 TΩ	20 nC
20 μA		1 TΩ	2 nC
2 μA		100 GΩ	
200 nA		10 GΩ	
20 nA		10 GΩ	
2 nA		100 MΩ	
200 pA		10 MΩ	
20 pA		1 MΩ	
2 pA			

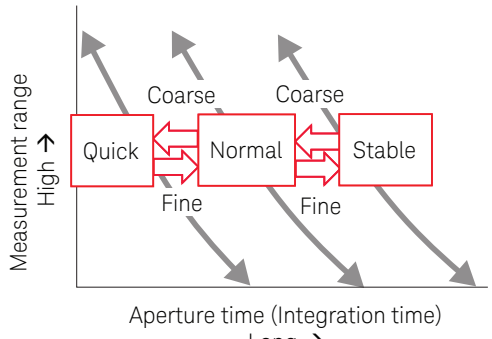

### How does the Navigation feature work?

The B2980A series possesses an innovative measurement navigation capability that helps users optimize both aperture time and measurement range. As shown below, it has three pre-programmed range vs. aperture curves that cover most logical combinations. By default measurements start using the "Normal" curve and an appropriate measurement range. However, if the measured data seems noisy then pressing the "Fine Res" key switches the settings over to the "Stable" curve. This will automatically adjust the settings to a longer aperture time and reduce the noise. In addition, if you need to make a rough measurement quickly then switching over to the "Quick" curve will save measurement time.

The Navigation feature's pre-defined curves enable even novice engineers and researchers to make low-level measurements quickly without any need to struggle over selecting the appropriate aperture time and range settings. Of course, experienced users can override these curves and use the instrument in purely manual mode if a particular measurement requires customized settings.

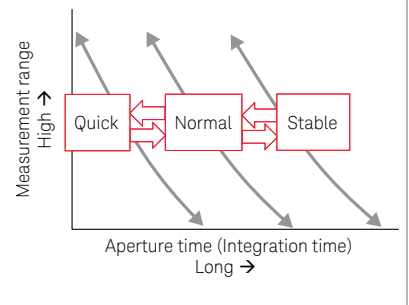

The "Real-time Noise Monitor" helps you to select the appropriate measurement settings by showing you the level of noise in your measurement. With this information you immediately know whether or not your measurement result is above or below the noise level. In addition, you can use this feature to select the appropriate aperture time (integration time) for your measurement environment.

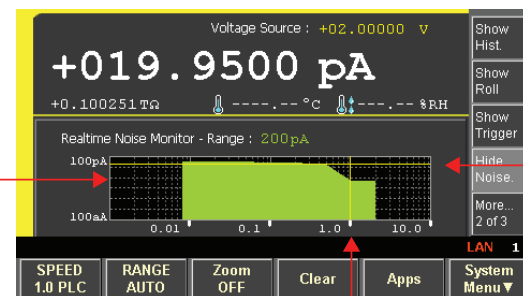

Noise level

Measured value

Current aperture time = 1 PLC (20 ms @ 50 Hz)

## Free PC-based software and multiple interface options provide flexible remote control choices

Keysight provides two PC-based software control options for the B2980A series: B2900A Quick I/V Measurement Software and a B2900A Graphical Web Interface. Quick I/V software can communicate with the B2980A series via several popular interfaces: LAN, GPIB (up to four B2980A series units) and USB (one B2980A series unit). It provides almost the same functionalities of your B2980A series' front panel. In addition, it supports a function that can automatically export measurement data into Microsoft Excel on your PC for further analysis. The Web Interface is embedded in each instrument and is only accessible via the LAN interface using a PC.

The Quick I/V Measurement Software also supports other B2900A precision instrument products (B2900A series of Source / Measure Units and B2960A series of Low Noise Power Sources).

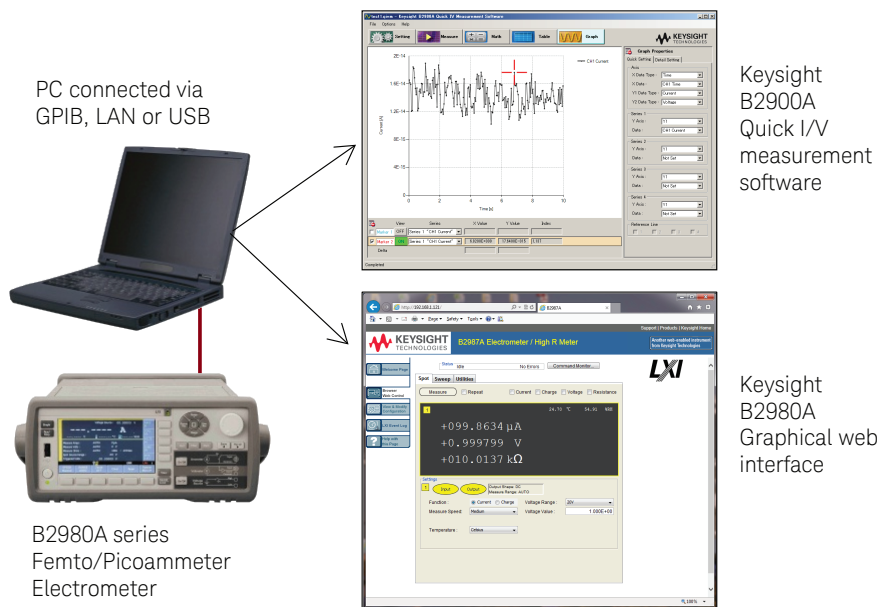

### What are the B2980A series' temperature and humidity measurement capabilities?

Temperature and humidity are critical parameters for high resistance measurements. The B2985A and B2987A electrometers contain both temperature and humidity sensor interfaces, and a dedicated thermocouple (N1423A) is furnished with these models. The EE07 Digital Humidity/Temperature Probe from E+E Elektronik can be used for humidity and temperature sensing, which provides more accurate temperature data than a thermocouple

### For more information

Please visit the product web pages containing demo videos, application information, sample programs, etc. from: [www.keysight.com/find/b2980a](http://www.keysight.com/find/b2980a)



## Ready-to-use instrument drivers simplify programming

For users that want to create their own customized software, IVI-C and IVI-COM drivers for the B2980A series are available. In addition, National Instrument's LabVIEW drivers are also available at NI.COM.

### Keysight B2900A family

The B2980A series is a member of B2900 Precision Instrument Family, which provide a variety of precision measurement solutions with both sourcing and measurement capabilities. The B2900A series of Source Measure Units (SMUs) have 6.5-digit resolution, enabling 100 nV/10 fA sourcing and measurement. The B2960A series of Low Noise Power Sources have up to 6.5-digit voltage/current sourcing resolution and a 10  $\mu$ Vrms noise floor. Both the B2900A series SMUs and B2960A series Power Sources have an output range of  $\pm 210$  V and  $\pm 3$  A (DC) or  $\pm 10.5$  A (pulsed), and they both utilize the same color LCD-based GUI. Further information on the B2900 Precision Instrument Family is available at <http://www.keysight.com/find/b2900a>.



B2900A Source Measure Unit



B2960A Low Noise Power Source



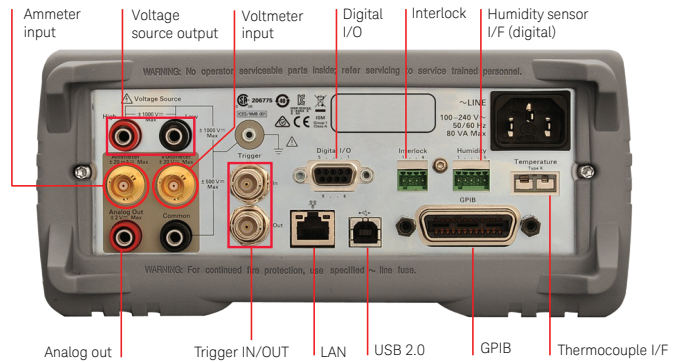
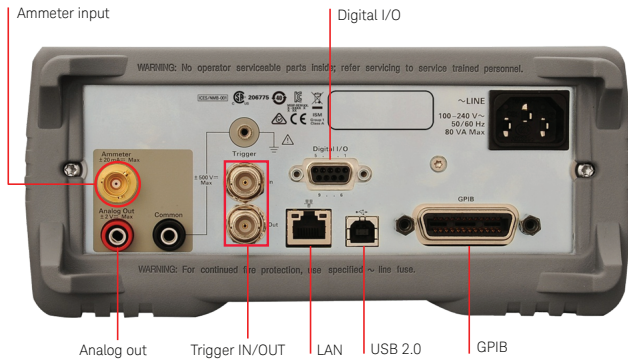
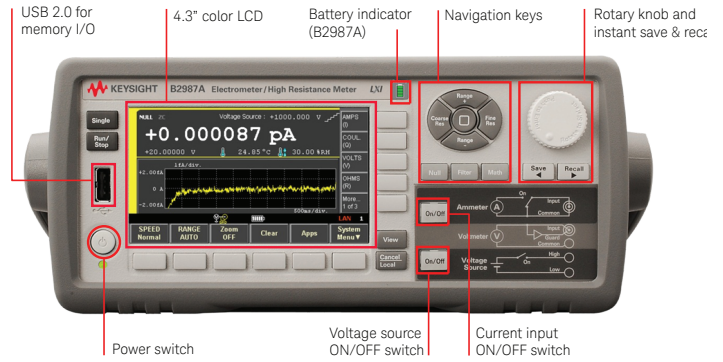
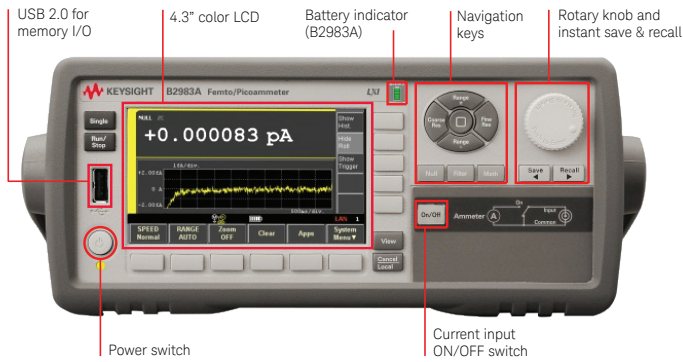

B2981A, B2983A  
Femto/Picoammeter

B2985A, B2987A  
Electrometer/High Resistance Meter

Compatibility table for optional high performance accessories and productivity tools

Product	Femto/Picoammeter		Electrometer/High Resistance Meter	
	B2981A	B2983A	B2985A	B2987A
16494A Triaxial cable (0.4 m, 0.8 m, 1.5 m, 3 m, 4 m)	√ (1.5 m furnished)	√ (1.5 m furnished)	√ (1.5 m furnished)	√ (1.5 m furnished)
N1413A High resistance meter fixture adapter			√	√
N1414A High resistance measurement universal adapter			√	√
16008B Resistivity cell (Obsoleted)			√	√
N1418A Lithium-ion battery pack		√ (furnished)		√ (furnished)
N1420A Setup integrity checker for B2980 series (software license)	√	√	√	√

B2980A accessories for high measurement performance and convenience



## Technical Specifications and Characteristics

Specification conditions				
Temperature: 23°C ± 5°C				
Humidity: 30% to 80% RH				
After 1 hour warm-up				
Ambient temperature change: less than ± 3°C after self-calibration				
Calibration period: 1 year				
Current measurement				
Measurement range	Display resolution	Accuracy ± (% + offset)	Input burden voltage at SelfCal ± 3°C <sup>1</sup>	Measurement settling time <sup>1,2</sup>
2 pA	1 aA	1 + 3 fA	20 μV	16 s
20 pA	10 aA	0.5 + 3 fA	20 μV	1.4 s
200 pA	100 aA	0.5 + 5 fA	20 μV	1.4 s
2 nA	1 fA	0.2 + 300 fA	20 μV	13 ms
20 nA	10 fA	0.2 + 500 fA	20 μV	13 ms
200 nA	100 fA	0.2 + 5 pA	20 μV	1.2 ms
2 μA	1 pA	0.1 + 50 pA	20 μV	550 μs
20 μA	10 pA	0.05 + 500 pA	20 μV	600 μs
200 μA	100 pA	0.05 + 5 nA	100 μV	600 μs
2 mA	1 nA	0.05 + 50 nA	1 mV	100 μs
20 mA	10 nA	0.05 + 500 nA	6 mV	100 μs
Temperature coefficient 0 to 18°C and 28 to 45°C		± (0.05 x Accuracy)/°C		
Supplemental characteristics				
Temperature coefficient of input voltage burden		< 10 μV/°C on pA, nA and μA ranges		
RMS noise		140 aA for 2 pA range, 10 s duration, no cable, open cap		
NMRR <sup>3</sup>		> 60 dB		
Maximum input capacitance		10 nF on less than 20 μA ranges, 1 μF on other ranges		

### Notes

Conditions: properly zeroed, 6½-digit, 1 PLC, median filter on, moving average 10 points

1. Supplemental characteristics

2. 0.1% of final value, step size 0% to 100% of range

3. Normal mode rejection ratio, integration time = 1, 2, ..., 100 PLC; power line frequency ± 0.1%

Resistance measurement				
Measurement range	Display resolution	Accuracy ± (% + offset) <sup>1,2</sup>	Auto voltage source	Current measure range
1 MΩ	1 Ω	0.135 + 1 Ω	20 V	200 μA
10 MΩ	10 Ω	0.135 + 10 Ω	20 V	20 μA
100 MΩ	100 Ω	0.185 + 100 Ω	20 V	2 μA
1 GΩ	1 kΩ	0.285 + 1 kΩ	20 V	200 nA
10 GΩ	10 kΩ	0.285 + 10 kΩ	20 V	20 nA
100 GΩ	100 kΩ	0.41 + 100 kΩ	20 V	2 nA
1 TΩ	1 MΩ	0.45 + 1 MΩ	200 V	2 nA
10 TΩ	10 MΩ	0.625 + 10 MΩ	200 V	200 pA
100 TΩ	100 MΩ	0.75 + 100 MΩ	200 V	20 pA
1 PΩ	1 GΩ	2.6 + 1 GΩ	200 V	2 pA
Temperature coefficient 0 to 18°C and 28 to 45°C		± (0.1 x Accuracy)/°C		

### Notes

Conditions: Auto V-source ohms, properly zeroed, 6½-Digit, 1 PLC, median filter on, digital filter = 10 readings.

1. In the manual mode resistance can be calculated from specific source voltage and measured current. The measurement accuracy in the manual mode is determined by voltage source accuracy and ammeter accuracy as follows: Measurement Error = R reading x (Voltage% error + Voltage offset error / Voltage + Current measurement% error + 10 x Current measurement offset error / Current measurement range)

2. Current measurement range for both Auto and Manual modes: 10% of current range ≤ measured current ≤ 100% of current range

Voltage measurement		
Measurement range	Display resolution	Accuracy $\pm$ (% + offset)
2 V	1 $\mu$ V	0.025 + 40 $\mu$ V
20 V	10 $\mu$ V	0.025 + 400 $\mu$ V
Temperature coefficient 0 to 18°C and 28 to 45°C		$\pm$ (0.05 x Accuracy)/°C
Supplemental characteristics		
Input bias current	< 20 fA	
Input impedance	> 200 T $\Omega$ , parallel with < 20 pF (non-guarded) or < 2 pF (guarded)	
RMS noise	1.4 $\mu$ V for 2 V range, 10 s duration, shorted input	
NMRR <sup>1</sup>	> 60 dB	
CMRR <sup>2</sup>	> 140 dB at DC; > 70 dB at 50 Hz or 60 Hz	

## Notes

Conditions: properly zeroed, 6½-digit, 1 PLC

1. Normal mode rejection ratio, integration time = 1, 2, ..., 100 PLC; power line frequency  $\pm$  0.1%
2. Common mode rejection ratio: 1 k $\Omega$  LO lead unbalance. Add the NMRR for PLC integration time.

Charge measurement		
Measurement range	Display resolution	Accuracy <sup>1</sup> $\pm$ (% + offset)
2 nC	1 fC	0.4 + 50 fC
20 nC	10 fC	0.4 + 500 fC
200 nC	0.1 pC	0.4 + 5 pC
2 $\mu$ C	1 pC	0.4 + 50 pC
Temperature coefficient 0 to 18°C and 28 to 45°C		$\pm$ (0.1 x Accuracy)/°C

## Notes

Conditions: Properly zeroed, 6½-digit, 1 ms aperture, specifications apply at 1 to 10 ms after charge acquisition.

1. Add 6 fC/s to the accuracy specification for the time span between NULL and measurement

Voltage source					
Sourcing range	Display resolution	Accuracy $\pm$ (% + offset)	Output current <sup>1</sup>	Output noise <sup>2</sup>	Settling time to rated accuracy <sup>1,3</sup>
20 V	700 $\mu$ V	0.05 + 2 mV	$\pm$ 20 mA	55 $\mu$ Vp-p (0.1 Hz to 10 Hz) 1.6 mVrms (10 Hz to 20 MHz)	200 $\mu$ s
1000 V	35 mV	0.05 + 100 mV	$\pm$ 1 mA	2.6 mVp-p (0.1 Hz to 10 Hz) 3.0 mVrms (10 Hz to 20 MHz)	5 ms
Temperature coefficient 0 to 18°C and 28 to 45°C		$\pm$ (0.05 x Accuracy)/°C			
Source function		DC, sweep (linear single, linear double, list), ARB (square)			

## Notes

1. Supplemental characteristics
2. 10 Hz to 20 MHz: Supplemental characteristics
3. Open load

Temperature measurement (Thermocouple)			
Temperature sensor	Range	Accuracy $\pm$ (% + offset) <sup>1</sup>	Unit
Type-K thermocouple	-25°C to 150°C	0.2% + 2°C	°C, °F and K
Temperature probe in humidity sensor <sup>2</sup>	-40°C to 80°C	0.5°C	°C, °F and K

## Notes

1. Thermocouple accuracy excluded for thermocouple, temperature probe accuracy included for humidity sensor
2. Supported humidity sensor: EE07 Digital Humidity / Temperature Probe from E+E Elektronik

Humidity measurement	
Range	Accuracy <sup>1</sup>
0% to 100%	2% RH (0% to 90% RH) 3% RH (90% to 100% RH)
Connector	2.5 mm pluggable terminal block, 5 pins (mating with Phoenix Contact 1881354)
Supported sensor	EE07 Digital Humidity / Temperature Probe from E+E Elektronik

## Notes

- Sensor accuracy included

Measurement buffer and speed					
Reading buffer	100,000				
Supplemental characteristics					
Measurement speed and performance	Reading rates			Additional noise error	
	Integration time <sup>1</sup>	To buffer	To GPIB	Current measurement	Voltage measurement
	100 PLC / 2 s	0.5 Readings/s	0.5 Readings/s	0% of range	0% of range
	10 PLC / 200 ms	5 Readings/s	5 Readings/s	0% of range	0% of range
	1 PLC / 20 ms	49 Readings/s	49 Readings/s	0.01% of range	0% of range
	0.1 PLC / 2 ms	500 Readings/s	490 Readings/s	0.03% of range	0.0005% of range
	0.01 PLC / 200 $\mu$ s	4,500 Readings/s	3,950 Readings/s	0.06% of range	0.001% of range
	0.001 PLC / 20 $\mu$ s	20,000 Readings/s	12,500 Readings/s	0.1% of range	0.004% of range

## Notes

- 50 Hz, fixed range

Timer and trigger functions		
Timer	Time stamp	TIMER value automatically saved when each measurement is triggered
	Resolution	10 $\mu$ s, 100 $\mu$ s, 1 ms, 10 ms, 100 ms
	Min. Measurement Interval	10 $\mu$ s, independent from Source
	Min. Source Interval	100 $\mu$ s, independent from Measure
	Accuracy	$\pm$ 50 ppm
	Arm/trigger delay	0 $\mu$ s to 100,000 s
	Arm/trigger interval	10 $\mu$ s (Measure), 100 $\mu$ s (Source) to 100,000 s
	Arm/trigger count	1 to 100,000 counts or infinity
Triggering <sup>1</sup>	Trigger in to trigger out	$\leq$ 5 $\mu$ s
	Trigger in to source change	$\leq$ 200 $\mu$ s
	Trigger in to measure	$\leq \pm$ 20 $\mu$ s
	Internal event to external LXI trigger	Minimum 100 $\mu$ s, Typical 200 $\mu$ s, Maximum unknown
	LXI event send/receive latency	Unknown

## Notes

- Supplemental characteristics

Battery operation (B2983A, B2987A)	
Technology	Li-ion battery with integrated smart battery monitor and charger
Capacity	14.40 V / 6,600 mAh / 95.0 Wh
Battery exchange	Customer exchangeable
Supplemental characteristics	
Typical operating time <sup>1</sup>	7 hours (B2983A), 5 hours (B2987A), 5% to shutdown, auto data save
Recharging time	7 hours to 100% capacity (AC in, Power On), 3.5 hours to 100% capacity (AC in, power Off)
Battery life	> 300 cycles with minimum 75% of initial capacity @25°C

## Notes

- Standalone, LCD on, input on, output off, auto triggered 2  $\mu$ A fixed range

Measurement control/navigation	
Ranging	Automatic or manual
Aperture time (integration time)	10 $\mu$ s to 100 PLC
Offset cancelling	Null, Zero correct
Digital filter	Median filter (2R + 1, R = 1 to 15), moving average (1 to 100, step 1)
Math	Preset and user definable expressions
Statistics	Histogram View mode: mean, sigma, # of bins and # of samples
Line frequency detection	Auto detect: 50 Hz or 60 Hz
Measurement indicators	"---" is displayed at no data captured, "OVERFLOW" is displayed over 105% of the range, "0 $\Omega$ " is displayed at current measurement overflow in Resistance measurement.
Front panel operation	
Front panel interface	4.3" TFT color display (16,000,000 colors, 480 x 272 pixels) with keypads and rotary knob
View mode	Meter view, Graph view, Histogram view and Roll view
Hardkeys	Single Trigger and Run/Stop control, measurement navigation keys (Null, Filter, Math, Save and Recall), Rotary Knob and Cursors, Ammeter Input and V Source Output control, Cancel/Local
Softkeys	Function, System and Input Assist Keys
Indicators	Channel (measurement) status, System status
LEDs	Power (color changes when charging), Input and Output (color changes when high voltage sourcing), Battery status (B2983A, B2987A)
Application softkey	Setup Integrity Checker (optional), Data logger, Demo Slide Show, About B2987A

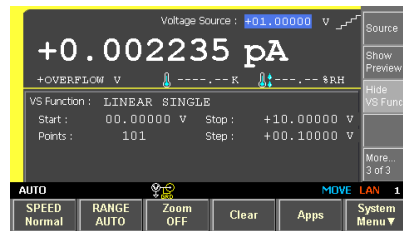

Meter view

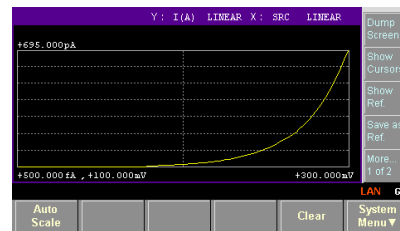

Graph view

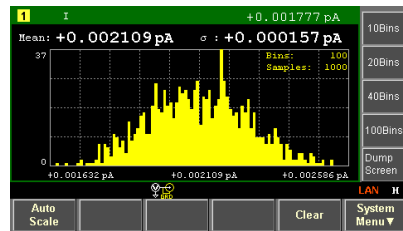

Histogram view

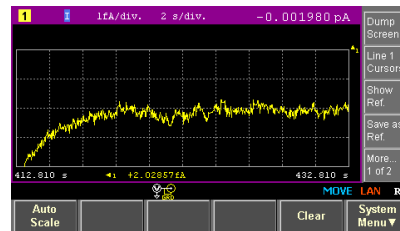

Roll view

Input/Output specifications		
Meter input connector		Three lug triaxial for ammeter on rear panel (B2981A, B2983A) Three lug triaxial for ammeter, and three lug triaxial for voltmeter on rear panel (B2985A, B2987A)
Guard		Switchable voltmeter guard available (B2985A, B2987A)
Maximum input		Ammeter: 30 mA, Voltmeter: 40 V
Source output connector		Two banana jacks on rear panel
Maximum common mode voltage		Meter common: 500 V peak: V Source 1,000 V peak
Isolation (Meter common to chassis)		> 10 G $\Omega$ , < 500 pF
Analog output		2 V for full range input, non-inverting in voltage and current measurement modes, 1 k $\Omega$ output impedance
Interlock		2.5 mm pluggable terminal block, 4 pin (mating with Phoenix Contact 1881341)
External trigger	Trigger input	BNC
	Logic	Programmable edge triggered
	Min pulse width	10 $\mu$ s
	Trigger output	BNC
	Logic	Programmable edge triggered
	Min pulse width	10 $\mu$ s

**Input/output specifications**

Digital I/O	Connector type	DSUB female 9 pins
	Input/output pins	DIO 7 pins, +5V, GND
	Absolute max input voltage	5.25 V
	Absolute min input voltage	-0.25 V
	Max logic L input voltage	0.8 V, Pull-up to 5 V by 5 kΩ
	Min logic H input voltage	2.0 V, Pull-up to 5 V by 5 kΩ
	Max source current	1 mA @ $V_o = 0$ V
	Max sink current	50 mA @ $V_o = 5$ V
	5 V power supply pin	Limited to 500 mA, resettable fuse protected

**Computer interfaces**

LXI (Rev. 1.4)	10/100Base-T Ethernet (Sockets, VXI-11 protocol, HiSLIP, and Web user interface)
USB	USB 2.0 (USB-TMC488 and MTP) USB host controller on the front, USB device interface on the rear Easy File Access
GP-IB	IEEE-488.2

**Program, software and drivers**

Programming	SCPI
Program memory	100 kB (1000 lines with 100 characters/line)
LXI compliance	LXI Core 2011
Software available	Quick I/V Measurement Software, Graphical Web Interface
Drivers available	IVI-C, IVI-COM drivers, LabVIEW drivers

**Environmental specifications**

Environment	For use in indoor facilities without air conditioning	
Operating	0°C to 45°C (0°C to 35°C when charging battery), 30% to 80% non-condensing	
Storage	-20°C to 60°C, 10% to 90% non-condensing	
Altitude	Operating: 0 m to 2000 m, Storage: 0 m to 4600 m	
Power supply	90 V to 264 V, 47 Hz to 63 Hz, 80 VA maximum	
EMC	IEC61326-1/EN61326-1, AS/NZS CISPR 11, KC: RRA Notification amending Radio Waves Act Article 58-2	
Safety	IEC61010-1/EN61010-1, CAN/CSA-C22.2 No. 61010-1-12, C/US	
Certifications	CE, cCSAus, RCM, KC	
Warm-up	1 hour	
Dimensions	Case	88 mm (2U) x 213 mm (half width) x 348 mm
	Working	104 mm x 261 mm x 374 mm (with bumper)
Weight	Net	4.3 kg (B2981A), 4.9 kg (B2983A), 4.5 kg (B2985A), 5.1 kg (B2987A)
	Shipping	8.5 kg (B2981A), 9.0 kg (B2983A), 8.7 kg (B2985A), 9.2 kg (B2987A)

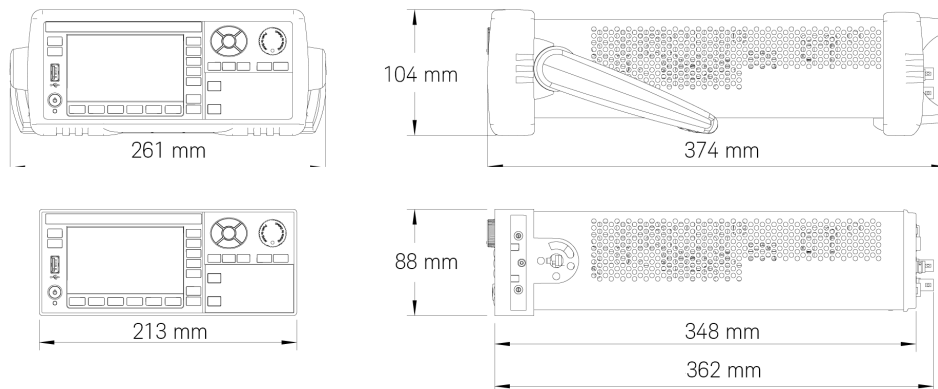

**Furnished accessories**

Power cable, USB cable, Triax cable (1.5m), Ground connection cable, Banana to screw-lug, Earthing wire(2m), Open cap for Triax. Connector, Quick Reference (English), CD-ROMs (including PDF manuals, Quick I/V Measurement Software and drivers, Keysight I/O Library Suite

In addition to the above, B2985A/B2987A includes the followings:

High voltage test leads, alligator clips, thermocouple, Interlock connector head, humidity probe connector head.

## Ordering Information

Model number	Description
B2981A	Femto/Picoammeter. 0.01 fA
B2983A	Femto/Picoammeter. 0.01 fA, battery
B2985A	Electrometer/High Resistance Meter, 0.01 fA, 1000 V
B2987A	Electrometer/High Resistance Meter, 0.01 fA, 1000 V, battery
Options	
A6J	ANSI Z540-1-1994 Calibration
UK6	Commercial calibration certificate with test data
B2980A-1CM	Rack Mount Kit
Manuals	
N1403A-ABA	User Guide English for B2980 Series
N1403A-ABJ	User Guide Japanese for B2980 Series
Accessories	
N1411A/B	Interlock cable, 4 pin terminal plug to 6 pin circular plug, (1.5 m/3 m)
N1413A	High resistance meter fixture adapter
N1414A	High resistance measurement universal adapter
N1415A	Triax to alligator cable, 200 V, 1.5 m
N1416A/B	Triax bulkhead connector (200 V/500 V)
N1417A	Open cap for triaxial connector
N1418A	Lithium-ion battery pack for B2983/B2987
N1419A	Benchtop battery charger for N1418A
N1423A	Thermocouple for B2985/B2987
16494A-001/002/005	Low leakage triax cable (1.5 m/3 m/4 m)
N1412/A/B/C	Low leakage triax cable (500 V, 1.5 m/3 m/6 m)
N1254A-102	Triax (female) to BNC (male) adaptor: For current measurement, floating DUT/sample
N1254A-104	Triax (female) to BNC (male) adaptor: For current measurement, grounded DUT/sample
N1254A-105	Triax (female) to BNC (male) adaptor: For voltage measurement
Productivity tools	
N1410A	Starter kit for B2985/B2987
N1420A	Setup integrity checker for B2980 series, fixed perpetual license
N1422A	High value resistor box for N1299A-301 evaluation kit
N1299A-301	Evaluation kit for B2981/83/85/87A

## Evolving Since 1939

Our unique combination of hardware, software, services, and people can help you reach your next breakthrough. We are unlocking the future of technology.

From Hewlett-Packard to Agilent to Keysight.

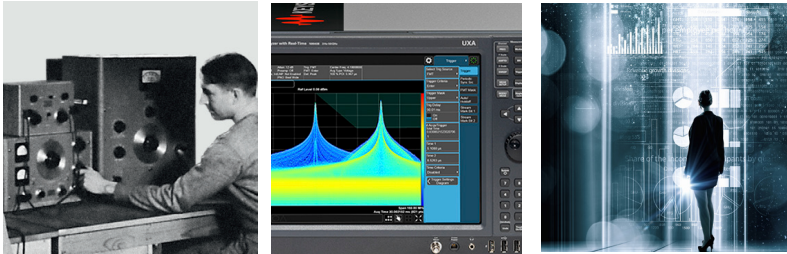

For more information on Keysight Technologies' products, applications or services, please contact your local Keysight office. The complete list is available at: [www.keysight.com/find/contactus](http://www.keysight.com/find/contactus)

### Americas

Canada	(877) 894 4414
Brazil	55 11 3351 7010
Mexico	001 800 254 2440
United States	(800) 829 4444

### Asia Pacific

Australia	1 800 629 485
China	800 810 0189
Hong Kong	800 938 693
India	1 800 11 2626
Japan	0120 (421) 345
Korea	080 769 0800
Malaysia	1 800 888 848
Singapore	1 800 375 8100
Taiwan	0800 047 866
Other AP Countries	(65) 6375 8100

### Europe & Middle East

Austria	0800 001122
Belgium	0800 58580
Finland	0800 523252
France	0805 980333
Germany	0800 6270999
Ireland	1800 832700
Israel	1 809 343051
Italy	800 599100
Luxembourg	+32 800 58580
Netherlands	0800 0233200
Russia	8800 5009286
Spain	800 000154
Sweden	0200 882255
Switzerland	0800 805353
	Opt. 1 (DE)
	Opt. 2 (FR)
	Opt. 3 (IT)
United Kingdom	0800 0260637

For other unlisted countries:

[www.keysight.com/find/contactus](http://www.keysight.com/find/contactus)  
(BP-9-7-17)

DEKRA Certified  
ISO 9001 Quality Management System

[www.keysight.com/go/quality](http://www.keysight.com/go/quality)

Keysight Technologies, Inc.  
DEKRA Certified ISO 9001:2015  
Quality Management System

### myKeysight

myKeysight

[www.keysight.com/find/mykeysight](http://www.keysight.com/find/mykeysight)

A personalized view into the information most relevant to you.

[http://www.keysight.com/find/emt\\_product\\_registration](http://www.keysight.com/find/emt_product_registration)

Register your products to get up-to-date product information and find warranty information.

**KEYSIGHT SERVICES**  
Accelerate Technology Adoption.  
Lower costs.

Keysight Services

[www.keysight.com/find/service](http://www.keysight.com/find/service)

Keysight Services can help from acquisition to renewal across your instrument's lifecycle. Our comprehensive service offerings—one-stop calibration, repair, asset management, technology refresh, consulting, training and more—helps you improve product quality and lower costs.

Keysight Assurance Plans

[www.keysight.com/find/AssurancePlans](http://www.keysight.com/find/AssurancePlans)

Up to ten years of protection and no budgetary surprises to ensure your instruments are operating to specification, so you can rely on accurate measurements.

Keysight Channel Partners

[www.keysight.com/find/channelpartners](http://www.keysight.com/find/channelpartners)

Get the best of both worlds: Keysight's measurement expertise and product breadth, combined with channel partner convenience.

[www.keysight.com/find/b2980a](http://www.keysight.com/find/b2980a)



This information is subject to change without notice.  
© Keysight Technologies, 2014 - 2017  
Published in USA, November 14, 2017  
5991-4878EN  
[www.keysight.com](http://www.keysight.com)