

1:2

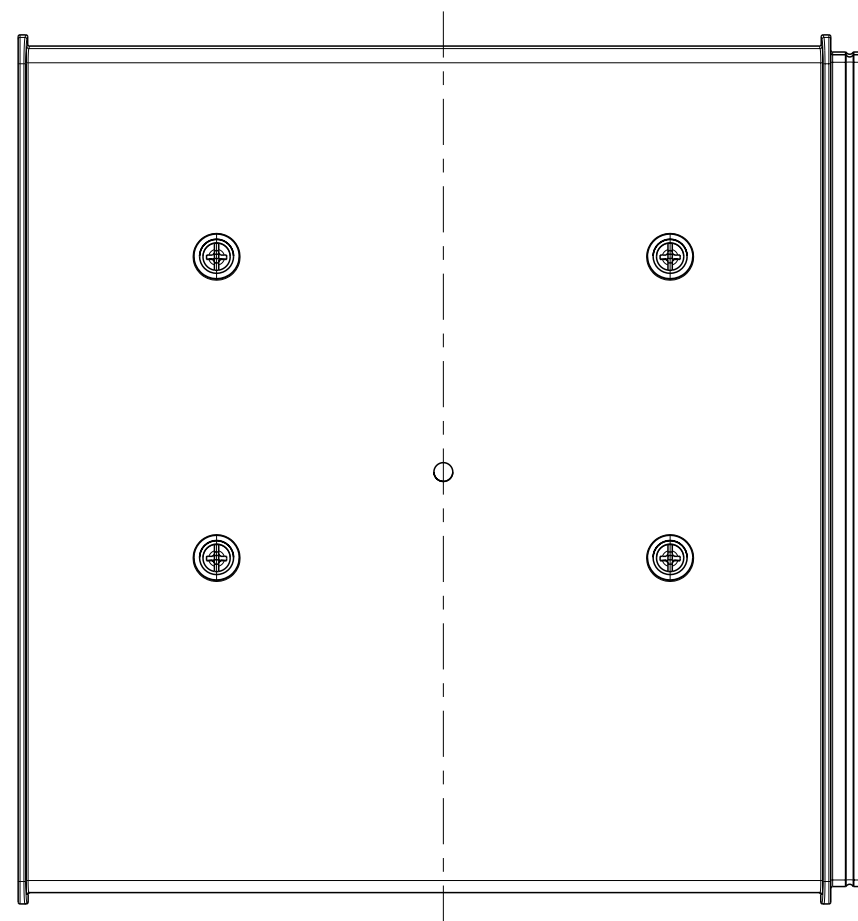
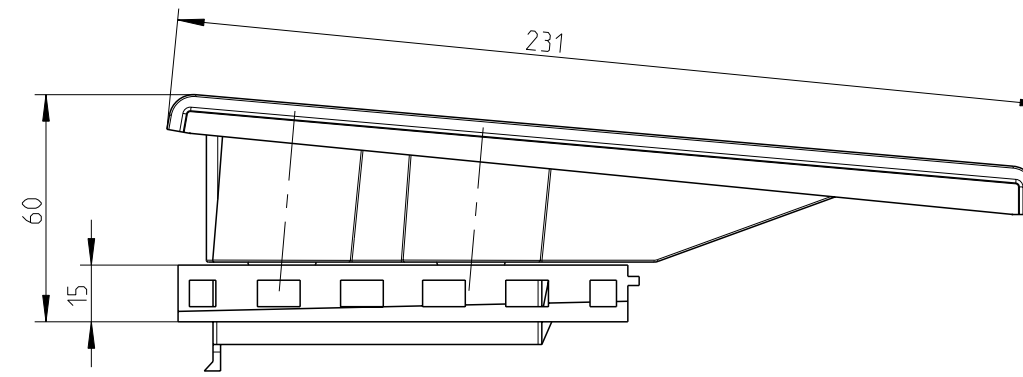
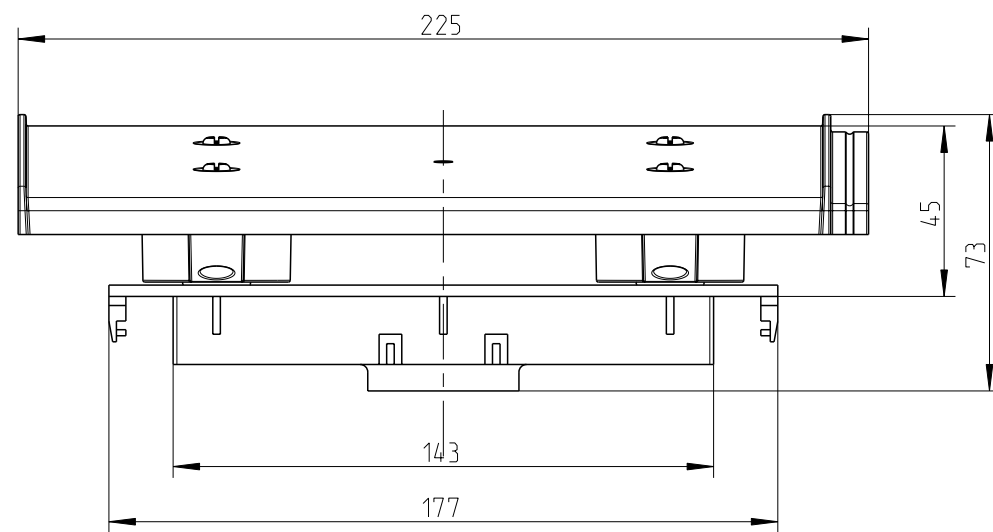
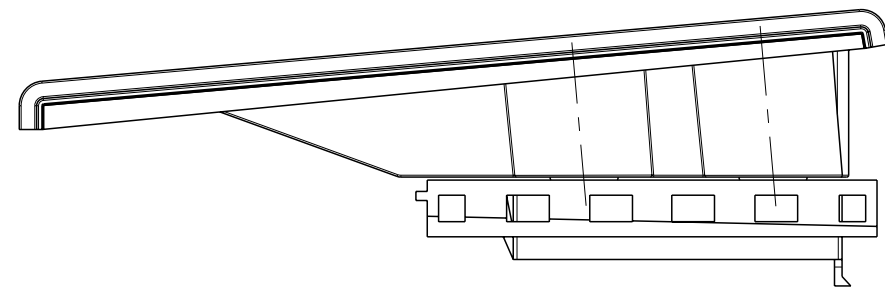

fehlende Bemaßungen können dem DXF entnommen werden
missing dimensions are provided in the dxf