



STP40NF10

N-channel 100 V, 0.025 Ω , 50 A TO-220
low gate charge STripFET™ II Power MOSFET

Features

Order code	V _{DSS}	R _{DS(on)} max.	I _D
STP40NF10	100 V	< 0.028 Ω	50 A

- Exceptional dv/dt capability
- Low gate charge
- 100% avalanche tested

Application

Switching applications

Description

This N-channel 100 V Power MOSFET is the latest development of STMicroelectronics unique "single feature size" strip-based process. The resulting transistor shows extremely high packing density for low on-resistance, rugged avalanche characteristics and less critical alignment steps allowing remarkable manufacturing reproducibility.

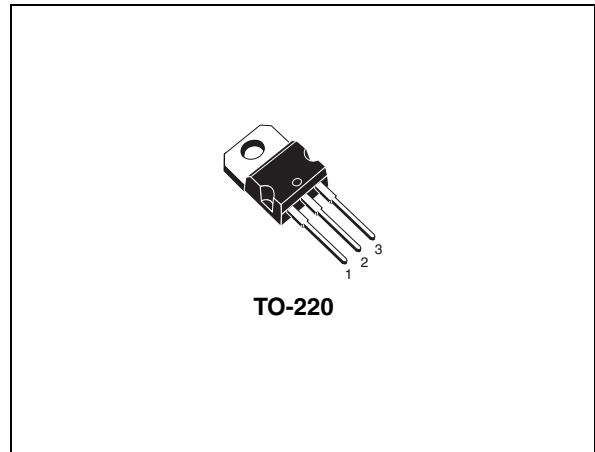

Figure 1. Internal schematic diagram

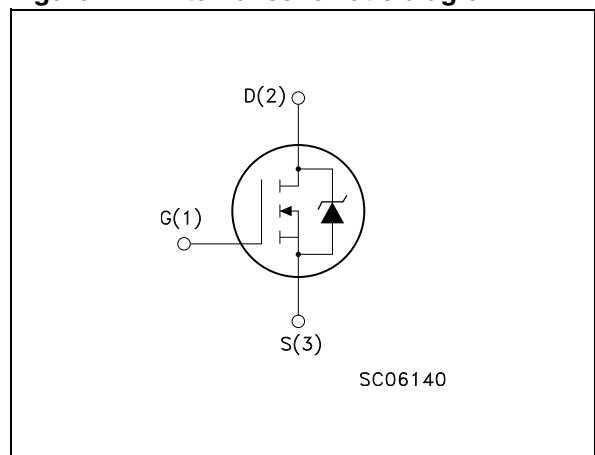

Table 1. Device summary

Order code	Marking	Package	Packaging
STP40NF10	P40NF10@	TO-220	Tube

Contents

1	Electrical ratings	3
2	Electrical characteristics	4
	2.1 Electrical characteristics (curves)	6
3	Test circuit	8
4	Package mechanical data	9
5	Revision history	11

1 Electrical ratings

Table 2. Absolute maximum ratings

Symbol	Parameter	Value	Unit
V_{DS}	Drain-source voltage ($V_{GS} = 0$)	100	V
V_{GS}	Gate- source voltage	± 20	V
$I_D^{(1)}$	Drain current (continuous) at $T_C = 25\text{ }^\circ\text{C}$	50	A
I_D	Drain current (continuous) at $T_C = 100\text{ }^\circ\text{C}$	35	A
$I_{DM}^{(2)}$	Drain current (pulsed)	200	A
P_{TOT}	Total dissipation at $T_C = 25\text{ }^\circ\text{C}$	150	W
	Derating factor	1	W/ $^\circ\text{C}$
$dv/dt^{(3)}$	Peak diode recovery voltage slope	27	V/ns
$E_{AS}^{(4)}$	Single pulse avalanche energy	385	mJ
T_{stg}	Storage temperature	- 55 to 175	$^\circ\text{C}$
T_j	Max. operating junction temperature		

1. Limited by wire bonding
2. Pulse width limited by safe operating area
3. $I_{SD} \leq 50\text{ A}$, $di/dt \leq 600\text{ A}/\mu\text{s}$, $V_{DD} \leq V_{(BR)DSS}$, $T_j \leq T_{JMAX}$.
4. Starting $T_j = 25\text{ }^\circ\text{C}$, $I_D = 50\text{ A}$, $V_{DD} = 25\text{ V}$

Table 3. Thermal data

Symbol	Parameter	Value	Unit
$R_{thj-case}$	Thermal resistance junction-case max	1	$^\circ\text{C}/\text{W}$
R_{thj-a}	Thermal resistance junction-ambient max	62.5	$^\circ\text{C}/\text{W}$
T_l	Maximum lead temperature for soldering purpose	300	$^\circ\text{C}$

2 Electrical characteristics

($T_{CASE} = 25\text{ °C}$ unless otherwise specified)

Table 4. On/off states

Symbol	Parameter	Test conditions	Min.	Typ.	Max.	Unit
$V_{(BR)DSS}$	Drain-source Breakdown voltage	$I_D = 250\ \mu A, V_{GS} = 0$	100			V
I_{DSS}	Zero gate voltage Drain current ($V_{GS} = 0$)	$V_{DS} = \text{Max rating}$ $V_{DS} = \text{Max rating}, T_C = 125\text{ °C}$			1 10	μA μA
I_{GSS}	Gate-body leakage current ($V_{DS} = 0$)	$V_{GS} = \pm 20\text{ V}$			± 100	nA
$V_{GS(th)}$	Gate threshold voltage	$V_{DS} = V_{GS}, I_D = 250\ \mu A$	2	3	4	V
$R_{DS(on)}$	Static drain-source on resistance	$V_{GS} = 10\text{ V}, I_D = 25\text{ A}$		0.025	0.028	Ω

Table 5. Dynamic

Symbol	Parameter	Test conditions	Min.	Typ.	Max.	Unit
$g_{fs}^{(1)}$	Forward transconductance	$V_{DS} = 15\text{ V}, I_D = 28\text{ A}$	-	22		S
C_{iss}	Input capacitance	$V_{DS} = 25\text{ V}, f = 1\text{ MHz}, V_{GS} = 0$	-	2180		pF
C_{oss}	Output capacitance			298		pF
C_{rss}	Reverse transfer capacitance			83.7		pF
Q_g	Total gate charge	$V_{DD} = 50\text{ V}, I_D = 40\text{ A}, V_{GS} = 10\text{ V}$ <i>(see Figure 15)</i>	-	46.5	62	nC
Q_{gs}	Gate-source charge			13.3		nC
Q_{gd}	Gate-drain charge			17.5	22.5	nC

1. Pulsed: Pulse duration = 300 μs , duty cycle 1.5.

Table 6. Switching times

Symbol	Parameter	Test conditions	Min.	Typ.	Max.	Unit
$t_{d(on)}$	Turn-on delay time	$V_{DD} = 50\text{ V}, I_D = 25\text{ A}$ $R_G = 4.7\ \Omega, V_{GS} = 10\text{ V}$ <i>(see Figure 14)</i>	-	21	-	ns
t_r	Rise time			46	-	ns
$t_{d(off)}$	Turn-off-delay time			54	-	ns
t_f	Fall time			13	-	ns

Table 7. Source drain diode

Symbol	Parameter	Test conditions	Min.	Typ.	Max	Unit
I_{SD}	Source-drain current		-		80	A
$I_{SDM}^{(1)}$	Source-drain current (pulsed)		-		320	A
$V_{SD}^{(2)}$	Forward on voltage	$I_{SD} = 50A, V_{GS} = 0$	-		1.5	V
t_{rr}	Reverse recovery time	$I_{SD} = 50A, V_{DD} = 25V$ $di/dt = 100A/\mu s,$ $T_j = 150^\circ C$ <i>(see Figure 16)</i>	-	80		ns
Q_{rr}	Reverse recovery charge			250		nC
I_{RRM}	Reverse recovery current			6.4		A

1. Pulse width limited by safe operating area.

2. Pulsed: Pulse duration = 300 μs , duty cycle 1.5%

2.1 Electrical characteristics (curves)

Figure 2. Safe operating area for TO-220

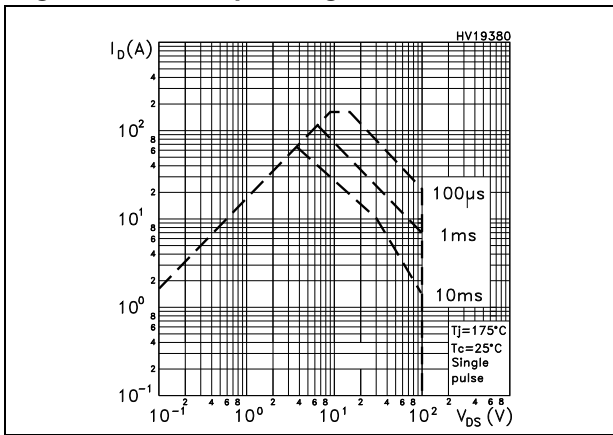

Figure 3. Thermal impedance for TO-220

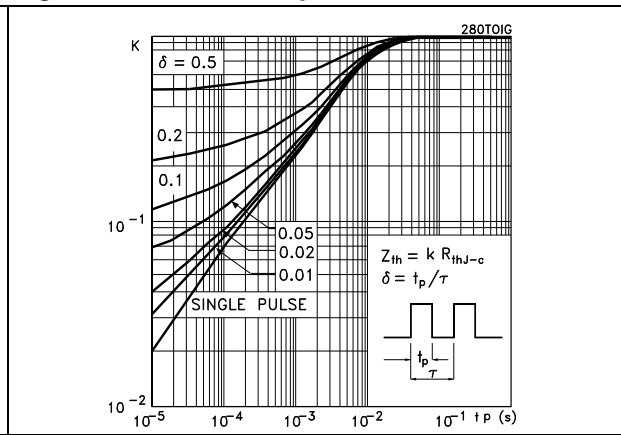

Figure 4. Output characteristics

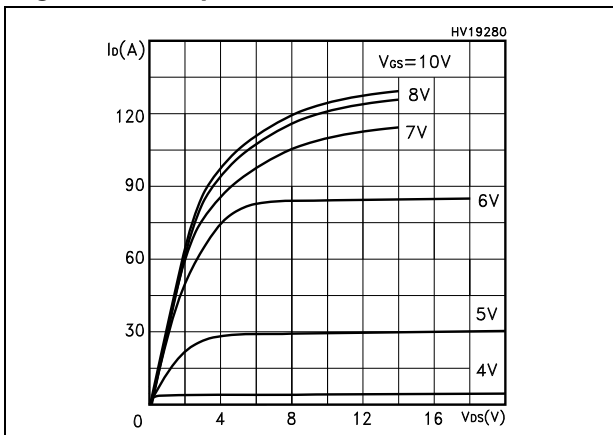

Figure 5. Transfer characteristics

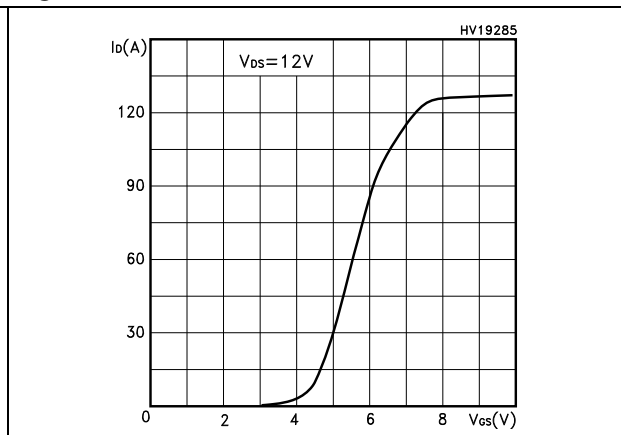

Figure 6. Transconductance

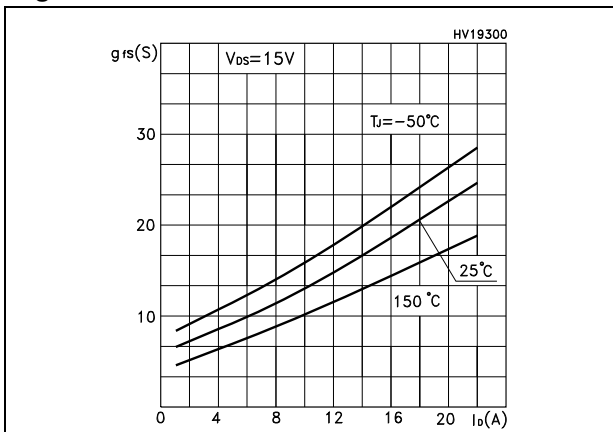

Figure 7. Static drain-source on resistance

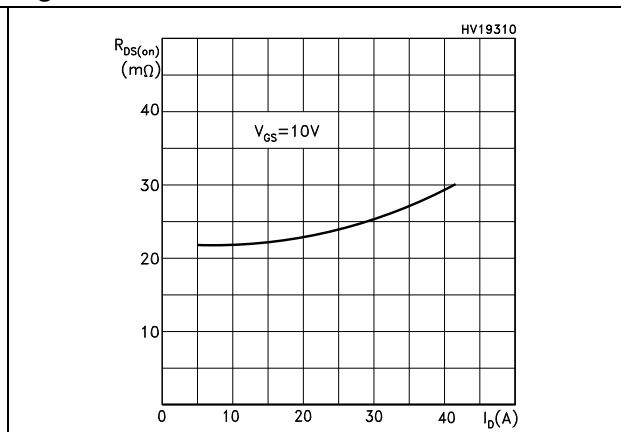

Figure 8. Gate charge vs. gate-source voltage Figure 9. Capacitance variations

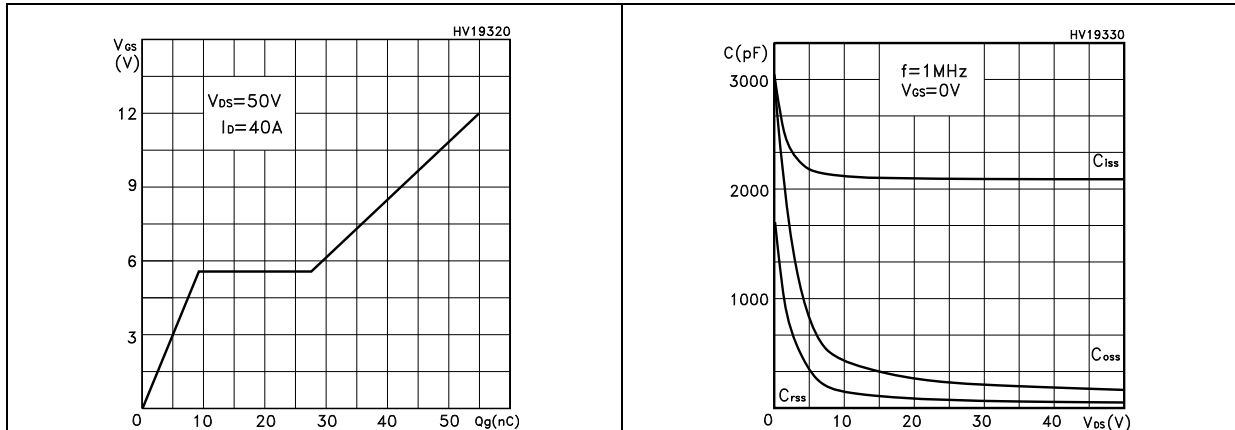

Figure 10. Normalized gate threshold voltage vs. temperature Figure 11. Normalized on resistance vs. temperature

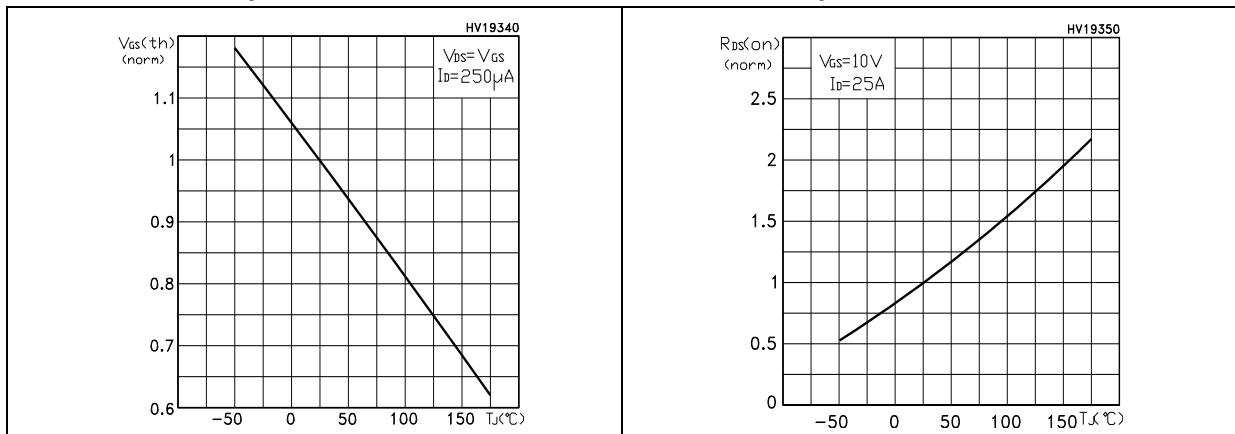
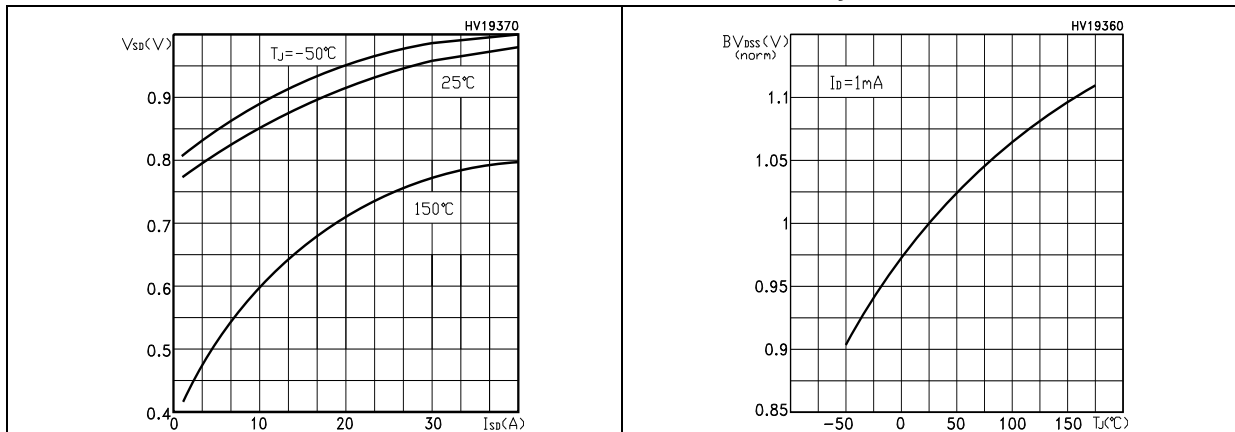

Figure 12. Source-drain diode forward characteristics Figure 13. Normalized breakdown voltage vs. T_j



3 Test circuit

Figure 14. Switching times test circuit for resistive load



Figure 15. Gate charge test circuit



Figure 16. Test circuit for inductive load switching and diode recovery times



Figure 17. Unclamped Inductive load test circuit



Figure 18. Unclamped inductive waveform

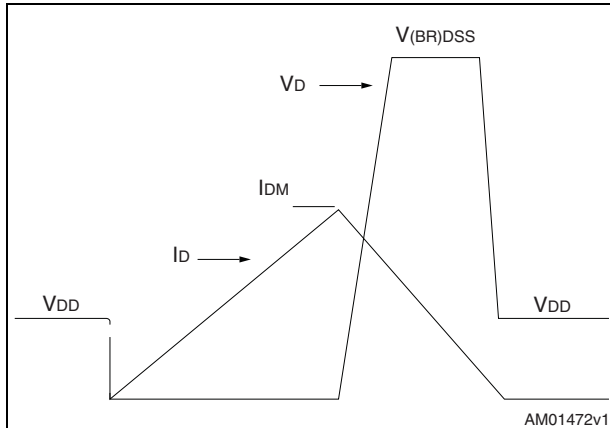
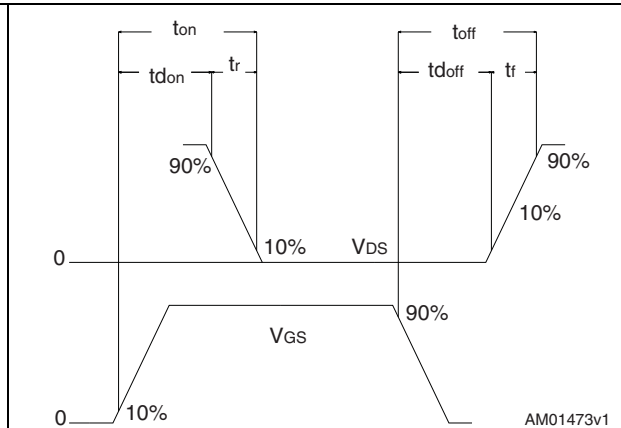

Figure 19. Switching time waveform



4 Package mechanical data

In order to meet environmental requirements, ST offers these devices in different grades of ECOPACK[®] packages, depending on their level of environmental compliance. ECOPACK[®] specifications, grade definitions and product status are available at: www.st.com. ECOPACK is an ST trademark.

TO-220 type A mechanical data

Dim	mm		
	Min	Typ	Max
A	4.40		4.60
b	0.61		0.88
b1	1.14		1.70
c	0.48		0.70
D	15.25		15.75
D1		1.27	
E	10		10.40
e	2.40		2.70
e1	4.95		5.15
F	1.23		1.32
H1	6.20		6.60
J1	2.40		2.72
L	13		14
L1	3.50		3.93
L20		16.40	
L30		28.90	
∅P	3.75		3.85
Q	2.65		2.95

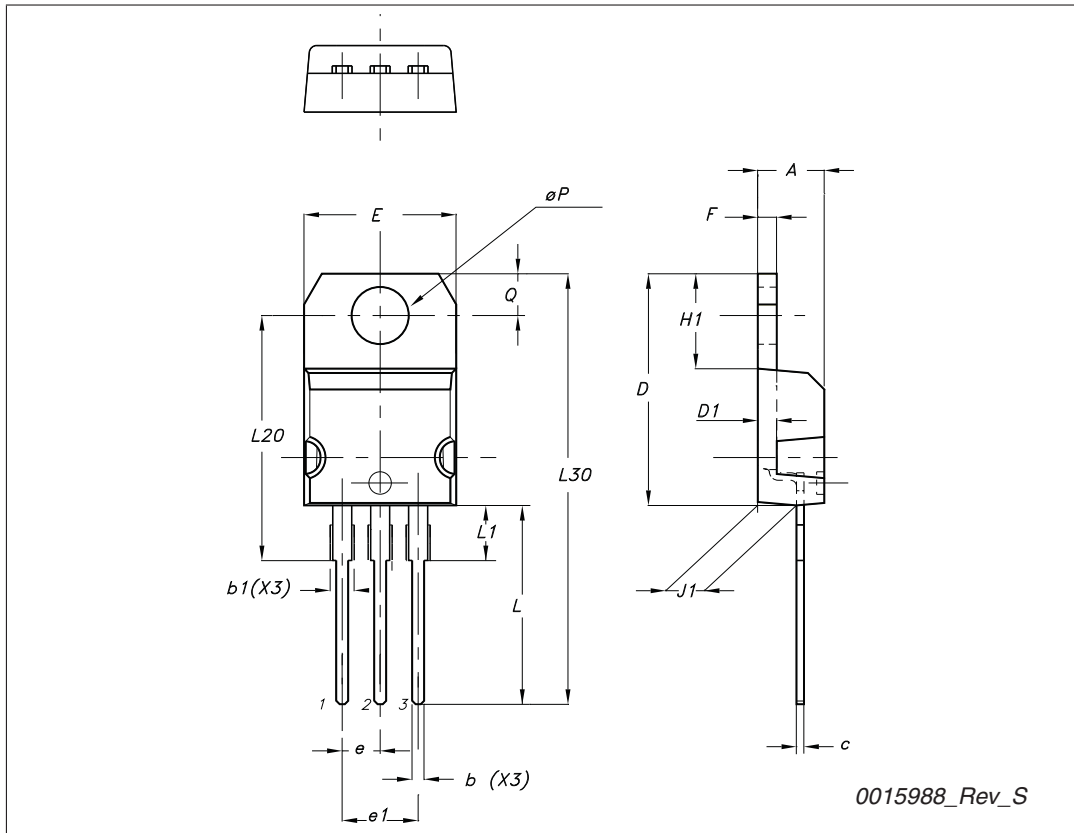

5 Revision history

Table 8. Document revision history

Date	Revision	Changes
16-Dec-2004	1	First version.
17-Aug-2006	2	The document has been reformatted.
31-Jan-2007	3	Typo mistake on Table 2 .
19-Sep-2007	4	Added DPAK.
10-Nov-2010	5	Removed DPAK.

Please Read Carefully:

Information in this document is provided solely in connection with ST products. STMicroelectronics NV and its subsidiaries ("ST") reserve the right to make changes, corrections, modifications or improvements, to this document, and the products and services described herein at any time, without notice.

All ST products are sold pursuant to ST's terms and conditions of sale.

Purchasers are solely responsible for the choice, selection and use of the ST products and services described herein, and ST assumes no liability whatsoever relating to the choice, selection or use of the ST products and services described herein.

No license, express or implied, by estoppel or otherwise, to any intellectual property rights is granted under this document. If any part of this document refers to any third party products or services it shall not be deemed a license grant by ST for the use of such third party products or services, or any intellectual property contained therein or considered as a warranty covering the use in any manner whatsoever of such third party products or services or any intellectual property contained therein.

UNLESS OTHERWISE SET FORTH IN ST'S TERMS AND CONDITIONS OF SALE ST DISCLAIMS ANY EXPRESS OR IMPLIED WARRANTY WITH RESPECT TO THE USE AND/OR SALE OF ST PRODUCTS INCLUDING WITHOUT LIMITATION IMPLIED WARRANTIES OF MERCHANTABILITY, FITNESS FOR A PARTICULAR PURPOSE (AND THEIR EQUIVALENTS UNDER THE LAWS OF ANY JURISDICTION), OR INFRINGEMENT OF ANY PATENT, COPYRIGHT OR OTHER INTELLECTUAL PROPERTY RIGHT.

UNLESS EXPRESSLY APPROVED IN WRITING BY AN AUTHORIZED ST REPRESENTATIVE, ST PRODUCTS ARE NOT RECOMMENDED, AUTHORIZED OR WARRANTED FOR USE IN MILITARY, AIR CRAFT, SPACE, LIFE SAVING, OR LIFE SUSTAINING APPLICATIONS, NOR IN PRODUCTS OR SYSTEMS WHERE FAILURE OR MALFUNCTION MAY RESULT IN PERSONAL INJURY, DEATH, OR SEVERE PROPERTY OR ENVIRONMENTAL DAMAGE. ST PRODUCTS WHICH ARE NOT SPECIFIED AS "AUTOMOTIVE GRADE" MAY ONLY BE USED IN AUTOMOTIVE APPLICATIONS AT USER'S OWN RISK.

Resale of ST products with provisions different from the statements and/or technical features set forth in this document shall immediately void any warranty granted by ST for the ST product or service described herein and shall not create or extend in any manner whatsoever, any liability of ST.

ST and the ST logo are trademarks or registered trademarks of ST in various countries.

Information in this document supersedes and replaces all information previously supplied.

The ST logo is a registered trademark of STMicroelectronics. All other names are the property of their respective owners.

© 2010 STMicroelectronics - All rights reserved

STMicroelectronics group of companies

Australia - Belgium - Brazil - Canada - China - Czech Republic - Finland - France - Germany - Hong Kong - India - Israel - Italy - Japan - Malaysia - Malta - Morocco - Philippines - Singapore - Spain - Sweden - Switzerland - United Kingdom - United States of America

www.st.com