

M12 MALE 0° / M12 FEMALE 90° LED

PUR 5X0.34 bk UL/CSA, drag ch 5m

Male straight to female 90°

M12 - M12, 5-pole

3 × LED (PNP), (NPN) on request

Art.-No. 7005 - M12 Lite - (plastic hexagonal screw) on request

Plastic housings with good resistance against chemicals and oils. The resistance to aggressive media should be individually tested for your application. Further details on request. Further cable lengths on request.

[Link to Product](#)

Illustration



(* for cable type 126 and 732)

Male

Female

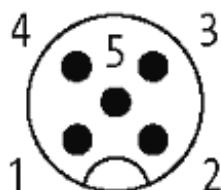

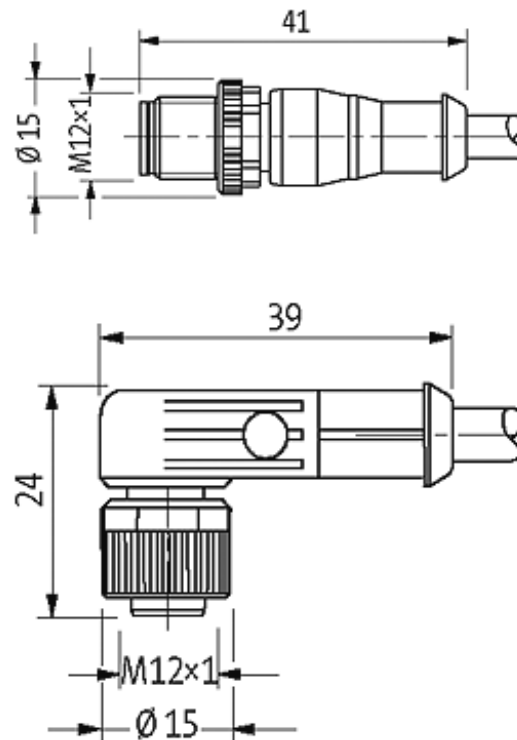

Product may differ from Image

Approvals



* only for products with UL/CSA approved cable

Form

40361

Technical Data

Operating voltage	24 V DC $\pm 25\%$
Operating current per contact	max. 4 A
Locking of ports	Screw thread M12 \times 1 mm (recommended torque 0.6 Nm) self-securing
Protection	IP67 inserted and tightened (EN 60529)

Cables

Cable number	635
No./diameter of wires	5 \times 0.34 mm ²
Wire isolation	PP (br, wh, bl, bk, gnye)
C-track properties	5 Mio.
Torsion	2 Mio. \pm 180°/m
Jacket Color	black
Shore hardness outer jacket	90 \pm 5A

The information in this brochure has been compiled with the utmost care.

Liability for the correctness completeness and topicality of the information is restricted to gross negligence. Version: 05/15

Murrelektronik GmbH | Falkenstraße 3, 71570 Oppenweiler | Fon +49 (71 91) 47-0, Fax +49 (71 91) 47-491000 | shop@murrelektronik.de | shop.murrelektronik.de

Material (jacket)	PUR (UL/CSA)
Outer diameter	approx. 5.0 mm
Bend radius (fixed)	5 × outer Ø
Bend radius (moving)	10 × outer Ø
Temperature range (fixed)	-40...+80 °C
Temperature range (mobile)	-25...+80 °C

Commercial data

country of origin	DE
customs tariff number	85444290
minimum order quantity	1