

Eccentric Quick Clamps · with screw

23390.0133



Product Description

For quick and easy clamping and releasing of workpieces.
When using the "adjustable" design (picture 2) the lever position can be moved.

Material

Support washer

- Thermoplastic POM, glass-fiber reinforced

Lever

- Zinc die-cast, plastic coated, black

Inner parts

- Steel, zinc-plated by galvanization

Screw

- Steel, zinc-plated by galvanization

Adjusting nut

- Steel, zinc-plated by galvanization

Drawing

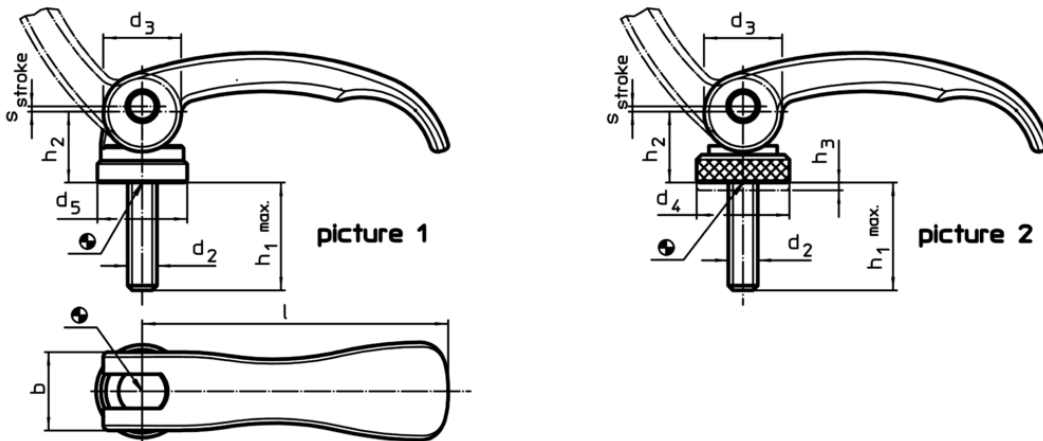

Order information

l	d ₂	h ₁ max. in clamping position	Dimensions				Regulating- range h ₃ min.	b	Stroke s at 90° lever position [mm]	max. [°C]	[g]	Art. No.
			d ₃	d ₄	h ₂ max.	[mm]						
with screw, adjustable – picture 2, steel												
63	M5	30	16	19	16.4	1.5	16	0.75	80	71	23390.0133	

Application example



Compliance

RoHS compliant

Contains lead - compliant according to exceptions 6a / 6b / 6c

Contains SVHC substances >0,1% w/w

Contains lead - SVHC list [REACH] as of 10.06.2022

Contains Proposition 65 substances



Lead can cause cancer and reproductive harm from exposure
<https://www.P65Warnings.ca.gov/>

Free from Conflict Minerals

This product does not contain any substances designated as "conflict minerals" such as tantalum, tin, gold or tungsten from the Democratic Republic of Congo or adjacent countries.