

# FIXED 2.5 AND 5 VOLT MINIATURE VOLTAGE REGULATORS

ISSUE 4 - MARCH 2002

**ZMR SERIES**

## DEVICE DESCRIPTION

The ZMR series of three terminal fixed positive voltage regulators feature internal current limit and will shut down under thermal overload conditions making the devices difficult to destroy.

The circuit design offers an exceptionally low quiescent current, only  $30\mu\text{A}$  for the 2.5 volt device, ideal for low power applications. The initial devices in the series regulate to 2.5 or 5 volts with a drive capability up to 50mA, however, the flexible design will allow other voltage selections to be made.

The device is designed with space saving in mind and is available in the small outline SOT23 package. The device is also available in through hole TO92 package.

## FEATURES

- Small outline SOT23 package
- TO92 package
- 2.5V and 5V output
- 22.5V maximum input voltage (ZMR25H)
- 25V maximum input voltage (ZMR50H)
- Output current up to 50mA
- Very low Quiescent current ( $30\mu\text{A}$ )
- Unconditionally stable
- Other output voltages possible
- Internal short circuit current limit

## VOLTAGE RANGE

ZMR250	2.5V
ZMR500	5.0V
ZMR25H	2.5V
ZMR50H	5.0V

## SCHEMATIC DIAGRAM

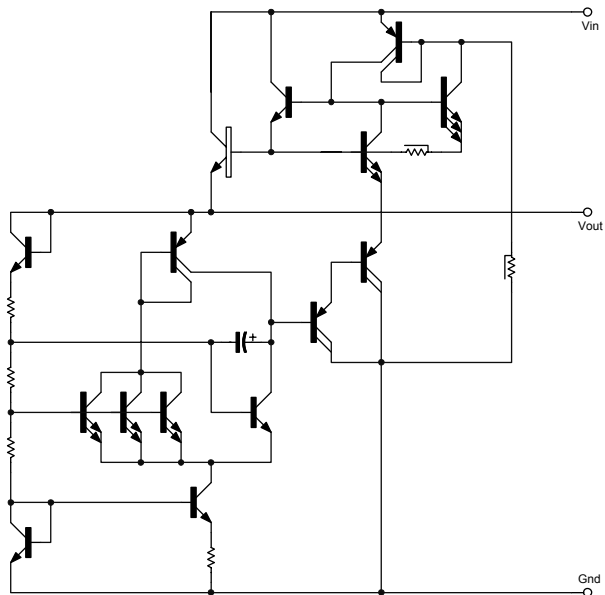

# ZMR SERIES

## ABSOLUTE MAXIMUM RATINGS

Input voltage (ZMR25H)	22.5V	ZMR250	20V
(ZMR50H)	25V	ZMR500	20V
Package power dissipation ( $T_{amb}=25^{\circ}\text{C}$ )		SOT23	500mW (Note 3)
		TO92	600mW
Output current ( $I_o$ )			100mA
Operating temperature			-55 to 125°C
Storage temperature			-65 to 150°C

### Note:

1. The maximum operating input voltage and output current of the device will be governed by the maximum power dissipation of the selected package. Maximum package power dissipation is specified at 25 °C and must be linearly derated to zero at  $T_{amb} = 125^{\circ}\text{C}$ .

2. The following data represents pulse test conditions with junction temperatures as indicated at the initiation of the test. Continuous operation of the devices with the stated conditions might exceed the power dissipation limits of the chosen package.

3. Maximum power dissipation for the SOT23 package, is calculated assuming that the device is mounted on a ceramic substrate measuring 15 x 15 x 0.6mm.

## ZMR25H

### ELECTRICAL CHARACTERISTICS

TEST CONDITIONS (Unless otherwise stated):  $T_j=25^{\circ}\text{C}$ ,  $I_o=10\text{mA}$ ,  $V_{in}=6.5\text{V}$

SYMBOL	PARAMETER	CONDITIONS	MIN.	TYP.	MAX.	UNITS
$V_o$	Output Voltage		2.438	2.5	2.563	V
		$I_o=0$ to 50mA $T_j=-55$ to 125°C	2.360		2.640	V
		$V_{in}=4.5$ to 22.5V $I_o=0$ to 50mA $T_j=-55$ to 125°C	2.360		2.640	V
$\Delta V_o$	Line Regulation	$V_{in}=4.5$ to 22.5V		5	15	mV
$\Delta V_o$	Load Regulation	$I_o=0$ to 50mA $I_o=0$ to 10mA		20 12	30	mV mV
$I_s$	Supply Current	$T_j=-55$ to 125°C		30	40	$\mu\text{A}$
$\Delta I_s$	Supply Current Change	$I_o=0$ to 50mA $V_{in}=4.5$ to 22.5V		1 2	$\pm 10$ 10	$\mu\text{A}$ $\mu\text{A}$
$V_n$	Output Noise Voltage	$f=10\text{Hz}$ to 10KHz		65		$\mu\text{V rms}$
$\Delta V_{in}/\Delta V_o$	Ripple Rejection	$V_{in}=6.3$ to 18V $f=120\text{Hz}$	55	75		dB
$V_{in}$	Input Voltage Required To Maintain Regulation		4.2	3.9		V
$\Delta V_o/\Delta T$	Average Temperature Coefficient of $V_o$	$I_o=5.0\text{mA}$ $T_j=-55$ to 125°C		0.275	0.700	mV/°C

# ZMR SERIES

## ZMR50H

### ELECTRICAL CHARACTERISTICS

TEST CONDITIONS (Unless otherwise stated):  $T_j=25^{\circ}\text{C}$ ,  $I_O=10\text{mA}$ ,  $V_{in}=10\text{V}$

SYMBOL	PARAMETER	CONDITIONS	MIN.	TYP.	MAX.	UNITS
$V_O$	Output Voltage		4.875	5	5.125	V
		$I_O=0$ to 50mA $T_j=-55$ to $125^{\circ}\text{C}$	4.780		5.160	V
		$V_{in}=7$ to 25V $I_O=0$ to 50mA $T_j=-55$ to $125^{\circ}\text{C}$	4.780		5.175	V
$\Delta V_O$	Line Regulation	$V_{in}=7$ to 25V		5	15	mV
$\Delta V_O$	Load Regulation	$I_O=0$ to 50mA $I_O=0$ to 10mA		25 15	40	mV mV
$I_s$	Supply Current	$T_j=-55$ to $125^{\circ}\text{C}$		50	70	$\mu\text{A}$
$\Delta I_s$	Supply Current Change	$I_O=0$ to 50mA $V_{in}=7$ to 25V		1	$\pm 10$	$\mu\text{A}$
				2	10	$\mu\text{A}$
$V_n$	Output Noise Voltage	$f=10\text{Hz}$ to $10\text{KHz}$		90		$\mu\text{V rms}$
$\Delta V_{in}/\Delta V_O$	Ripple Rejection	$V_{in}=8$ to 18V $f=120\text{Hz}$	55	72		dB
$V_{in}$	Input Voltage Required To Maintain Regulation		7	6.7		V
$\Delta V_O/\Delta T$	Average Temperature Coefficient of $V_O$	$I_O=5.0\text{mA}$ $T_j=-55$ to $125^{\circ}\text{C}$		0.275	0.700	$\text{mV}/^{\circ}\text{C}$

# ZMR SERIES

## ZMR250

### ELECTRICAL CHARACTERISTICS

TEST CONDITIONS (Unless otherwise stated):  $T_j=25^{\circ}\text{C}$ ,  $I_O=10\text{mA}$ ,  $V_{in}=6.5\text{V}$

SYMBOL	PARAMETER	CONDITIONS	MIN.	TYP.	MAX.	UNITS
$V_O$	Output Voltage		2.438	2.5	2.563	V
		$I_O=0$ to 50mA $T_j=-55$ to $125^{\circ}\text{C}$	2.360		2.640	V
		$V_{in}=4.5$ to 20V $I_O=0$ to 50mA $T_j=-55$ to $125^{\circ}\text{C}$	2.360		2.640	V
$\Delta V_O$	Line Regulation	$V_{in}=4.5$ to 20V		5	15	mV
$\Delta V_O$	Load Regulation	$I_O=0$ to 50mA $I_O=0$ to 10mA		20 12	30	mV mV
$I_s$	Supply Current	$T_j=-55$ to $125^{\circ}\text{C}$		30	40	$\mu\text{A}$
$\Delta I_s$	Supply Current Change	$I_O=0$ to 50mA $V_{in}=4.5$ to 20V		1 2	$\pm 10$ 10	$\mu\text{A}$ $\mu\text{A}$
$V_n$	Output Noise Voltage	$f=10\text{Hz}$ to 10KHz		65		$\mu\text{V rms}$
$\Delta V_{in}/\Delta V_O$	Ripple Rejection	$V_{in}=6.3$ to 18V $f=120\text{Hz}$	55	75		dB
$V_{in}$	Input Voltage Required To Maintain Regulation		4.2	3.9		V
$\Delta V_O/\Delta T$	Average Temperature Coefficient of $V_O$	$I_O=5.0\text{mA}$ $T_j=-55$ to $125^{\circ}\text{C}$		0.275	0.700	$\text{mV}/^{\circ}\text{C}$

# ZMR SERIES

## ZMR500

### ELECTRICAL CHARACTERISTICS

TEST CONDITIONS (Unless otherwise stated):  $T_j=25^{\circ}\text{C}$ ,  $I_O=10\text{mA}$ ,  $V_{in}=10\text{V}$

SYMBOL	PARAMETER	CONDITIONS	MIN.	TYP.	MAX.	UNITS
$V_O$	Output Voltage		4.875	5	5.125	V
		$I_O=0$ to 50mA $T_j=-55$ to $125^{\circ}\text{C}$	4.780		5.160	V
		$V_{in}=7$ to 20V $I_O=0$ to 50mA $T_j=-55$ to $125^{\circ}\text{C}$	4.780		5.175	V
$\Delta V_O$	Line Regulation	$V_{in}=7$ to 20V		5	15	mV
$\Delta V_O$	Load Regulation	$I_O=0$ to 50mA $I_O=0$ to 10mA		25 15	40	mV mV
$I_s$	Supply Current	$T_j=-55$ to $125^{\circ}\text{C}$		50	70	$\mu\text{A}$
$\Delta I_s$	Supply Current Change	$I_O=0$ to 50mA $V_{in}=7$ to 20V		1	$\pm 10$	$\mu\text{A}$
				2	10	$\mu\text{A}$
$V_n$	Output Noise Voltage	$f=10\text{Hz}$ to $10\text{KHz}$		90		$\mu\text{V rms}$
$\Delta V_{in}/\Delta V_O$	Ripple Rejection	$V_{in}=8$ to 18V $f=120\text{Hz}$	55	72		dB
$V_{in}$	Input Voltage Required To Maintain Regulation		7	6.7		V
$\Delta V_O/\Delta T$	Average Temperature Coefficient of $V_O$	$I_O=5.0\text{mA}$ $T_j=-55$ to $125^{\circ}\text{C}$		0.275	0.700	$\text{mV}/^{\circ}\text{C}$

# ZMR SERIES

## TYPICAL CHARACTERISTICS

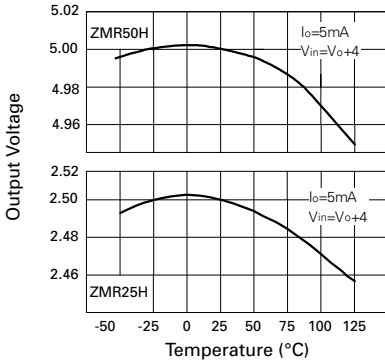

**Output Voltage Temperature**

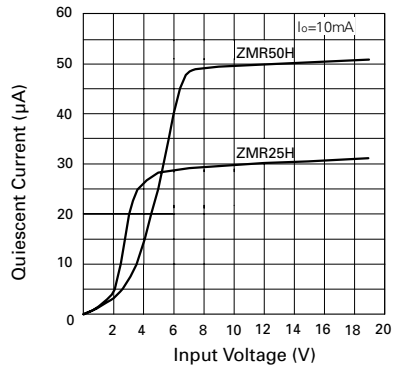

**Quiescent Current v Voltage**

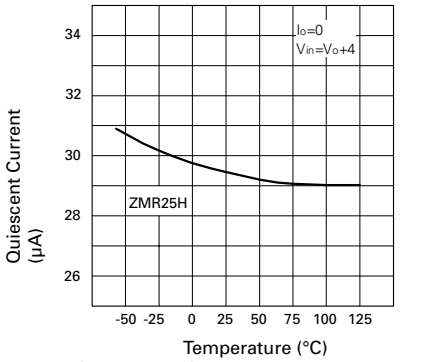

**Quiescent Current v Temperature**

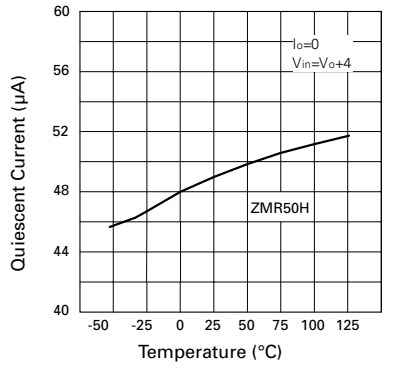

**Quiescent Current v Temperature**

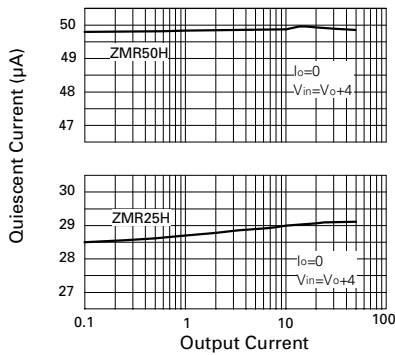

**Quiescent Current v Output Current**

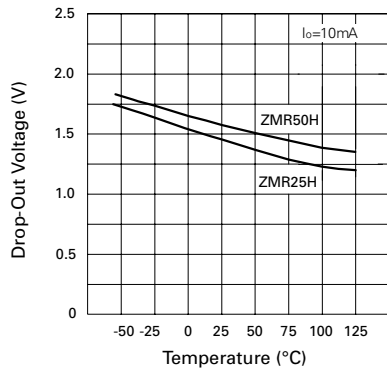

**Drop-Out Voltage v Temperature**

# ZMR SERIES

## TYPICAL CHARACTERISTICS

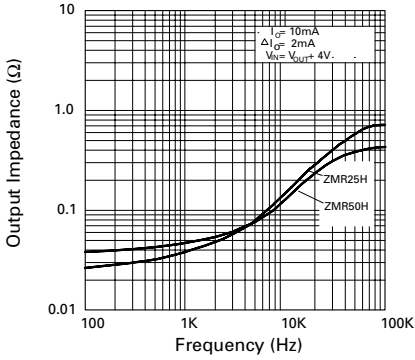

**Output Impedance v Frequency**

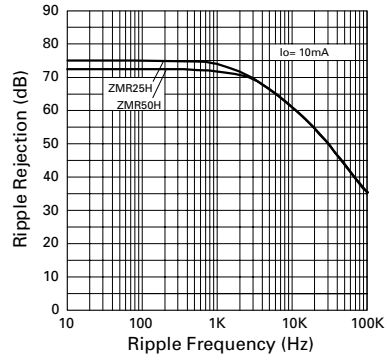

**Ripple Rejection v Ripple Frequency**

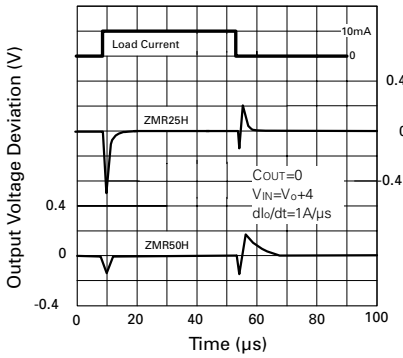

**Load Transient Response**

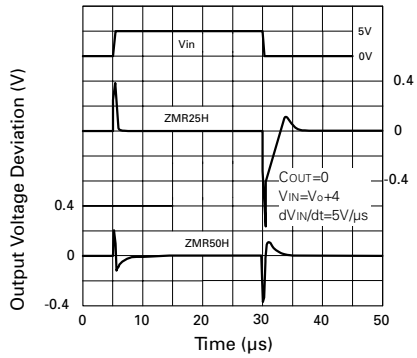

**Line Transient Response**

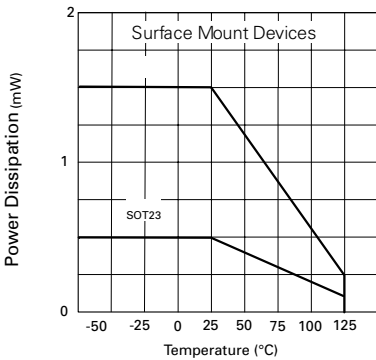

**Power Derating**

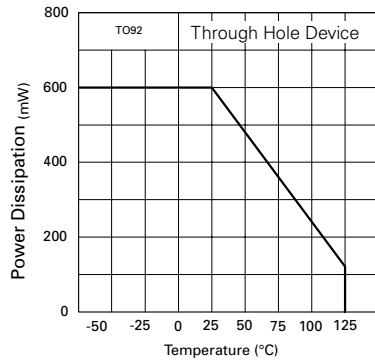

**Power Derating**

## TYPICAL CHARACTERISTICS

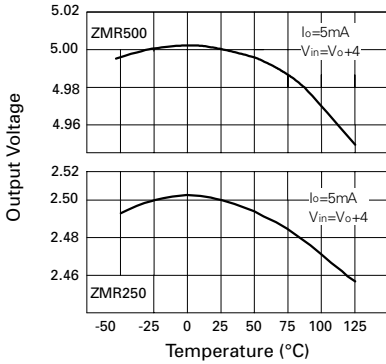

**Output Voltage Temperature**

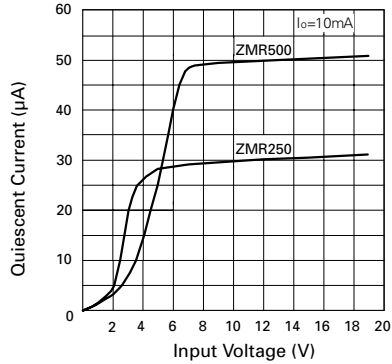

**Quiescent Current v Voltage**

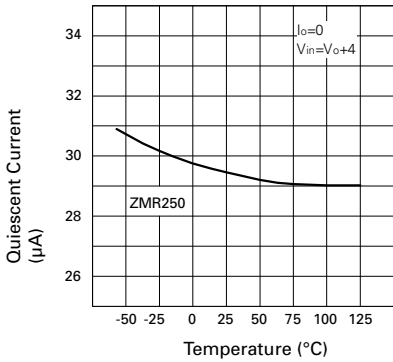

**Quiescent Current v Temperature**

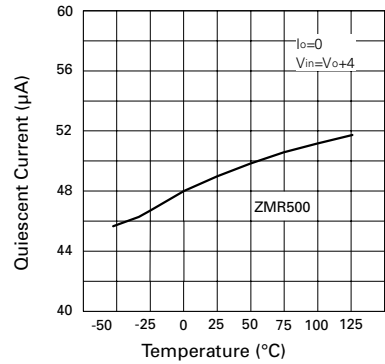

**Quiescent Current v Temperature**

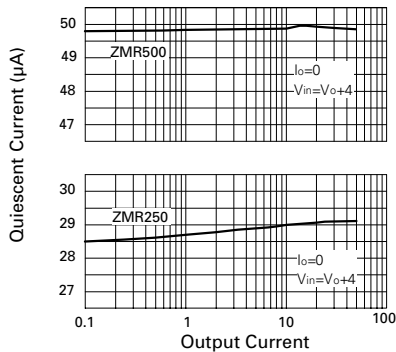

**Quiescent Current v Output Current**

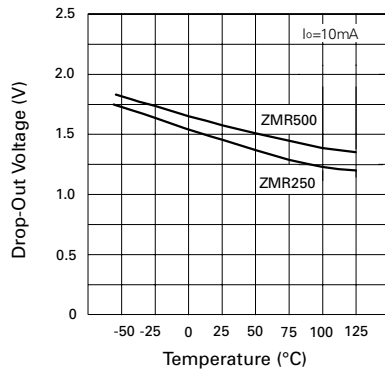

**Drop-Out Voltage v Temperature**



# ZMR SERIES

## TYPICAL CHARACTERISTICS

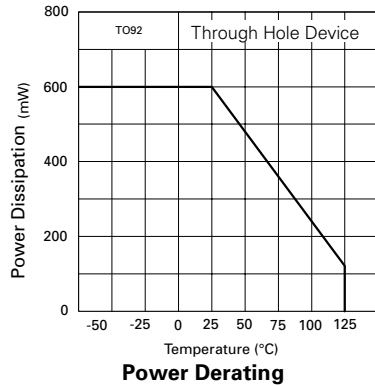
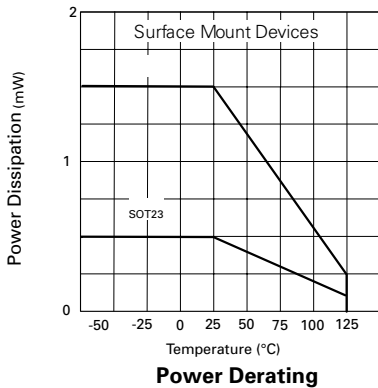
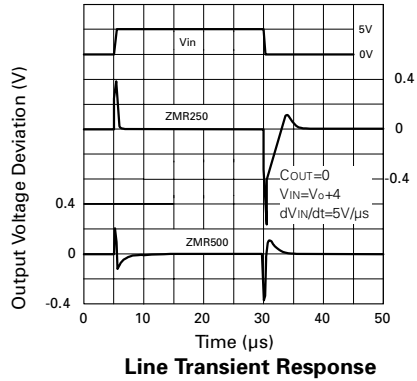
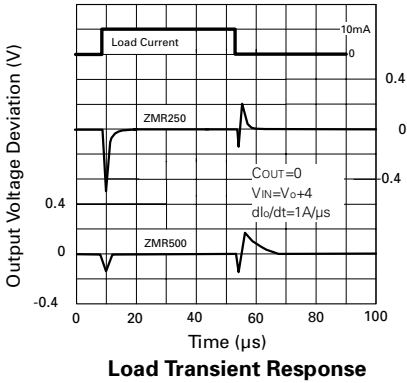
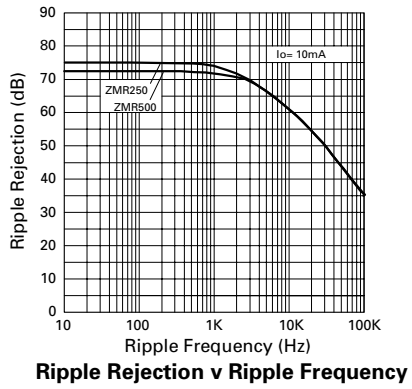
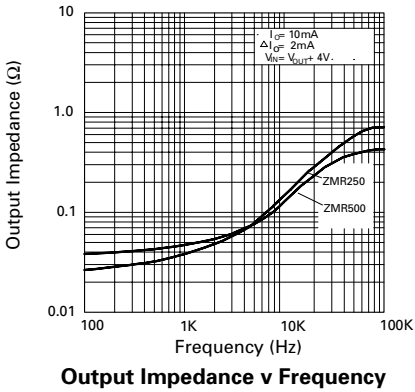

# ZMR SERIES

## CONNECTION DIAGRAMS

### SOT23 Package Suffix - F

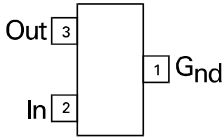

*Top View*

### TO92 Package Suffix - C

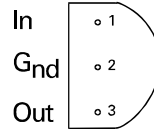

*Bottom View*

## ORDERING INFORMATION

Part Number	Package	Part Mark
ZMR250C	TO92	ZMR250
ZMR250F	SOT23	25K
ZMR25HC	TO92	ZMR25H
ZMR25HF	SOT23	25X
ZMR500C	TO92	ZMR500
ZMR500F	SOT23	50K
ZMR50HC	TO92	ZMR50H
ZMR50HF	SOT23	50R