

angular milling cutter 90° VSM490™-15
for indexable milling inserts XN.U 15T6..



Application:

the WIDIA™ Victory™ angular milling cutter range VSM490™-10 or 15 has been specifically developed for higher cutting volumes and excellent surface qualities of plane surfaces and shoulders. the 90° angular milling cutters are suitable for a wide range of material applications – steel, cast iron, stainless steel and titanium – for machining ranging from roughing to finishing.

Execution:

- double-sided, robust indexable insert with four cutting edges
- highly positive geometry for lower cutting forces
- excellent surface quality on shoulder and front surface
- with internal cooling

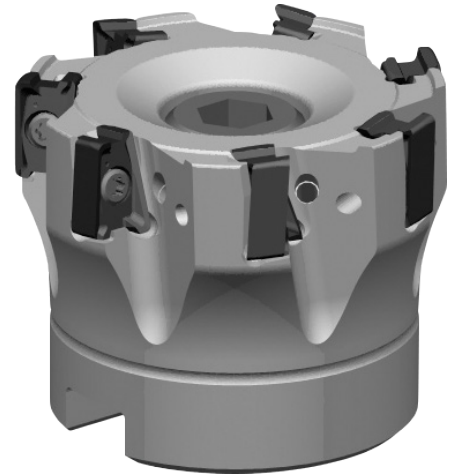

Art. no.	16043 678
Brand	WIDIA
Manufacturer Part Number	57 10522
Cutting edge diameter	50 mm
Length	40 mm
Bore diameter	22 mm
max. ap	15 mm
Number of cutting edges	6 PCS
Gross Weight	0.804 kg
Product Group	1XJ

EAN

4050841618489