

Static Dissipative Swabs

Product Description

Coventry™ Static Dissipative Technology Swabs have been engineered to eliminate static electricity concerns. The handle of these Coventry swabs are static dissipative. They are non-contaminating and have excellent solvent compatibility, even in acetone. These swabs are a perfect choice for cleaning static sensitive components and working around static sensitive parts. Blue handle material is more solvent resistant, while clear handles are stronger and more rigid.

- Surface resistivity of 1.0×10^{10} ohms/sq.
- Low ionic, nonvolatile residue, and particulate contamination
- No humidity dependency
- No amines or amides
- No silicones
- No static dissipative coatings
- No tribo-charge generated
- Handles will dissipate 99% of (5 kV) charge in 0.5 seconds
- Blue handles have excellent solvent resistance due to durable alloy

Compatibility

Fabric Swab Heads are generally compatible with all common solvents including ketones, toluene, dilute or weak acids.

Foam Swab Heads are compatible with most common solvents such as isopropyl alcohol and methanol. Foam swabs are typically not recommended for use with acetone or MEK.

Blue handle material is very resistant to all commonly used solvents.

Sealed Fabric ESD Swabs

- Proprietary single step sealing process
- Excellent strength and solvent compatibility
- Does not generate loose fibers or particles
- Head is thermoformed and welded to the handle; no adhesives or binders used
- Ultra-low ionic, nonvolatile residue, and particle contamination

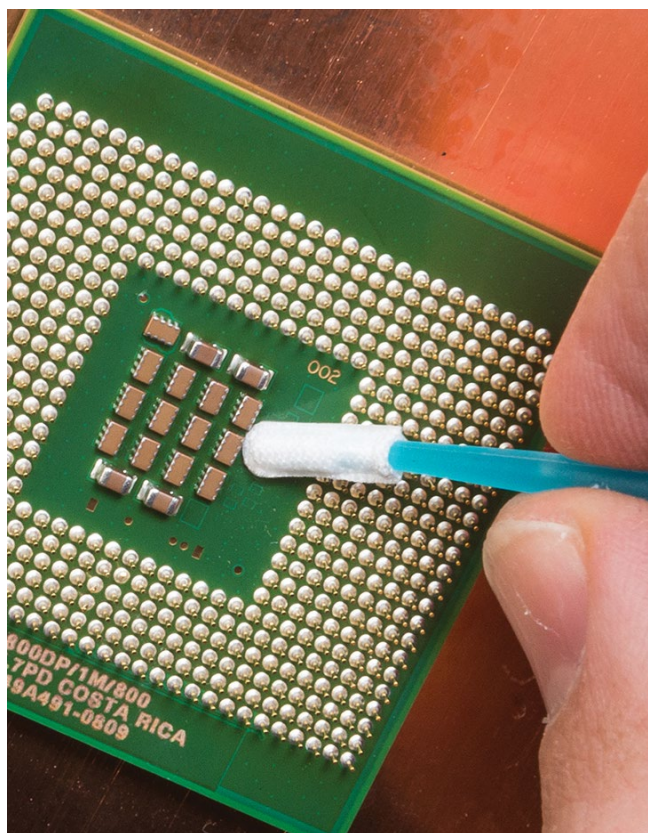

31040ESD	2.8" (7.2 cm) blue handle, 0.12" (3.1 mm) knit polyester head, 500/ bag
36060ESD	5.8" (14.7 cm) blue handle, 0.19" (4.7 mm) knit polyester head, 500/ bag
38040ESD	2.7" (6.9 cm) blue handle, 0.09" (2.3 mm) knit polyester head, 500/ bag
38540ESD	2.7" (6.9 cm) blue handle, 0.12" (3.1 mm) knit polyester head, 500/ bag
36861CLR	6.5" (16.5 cm) clear handle, 0.28" (7 mm) foam head, 500/ bag

TECHNICAL Data Sheet

Rev. D (6/19) Page 2 of 5

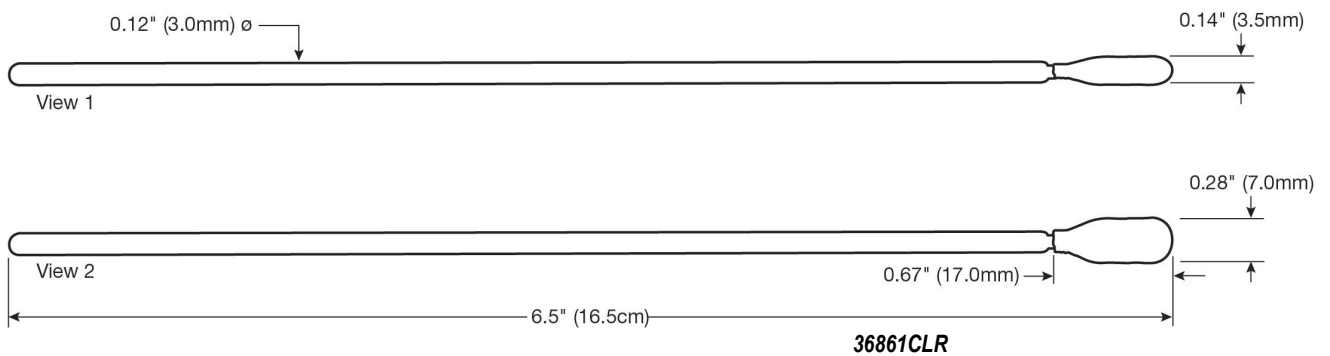
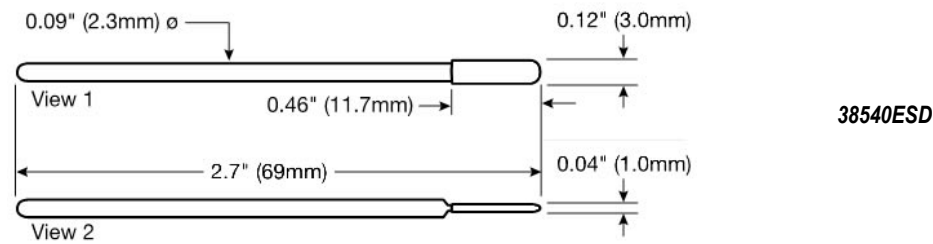
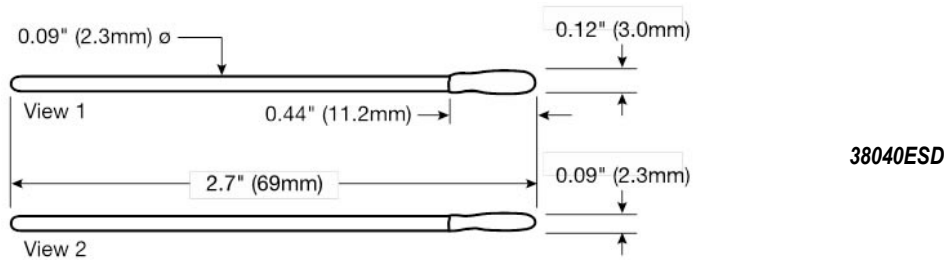
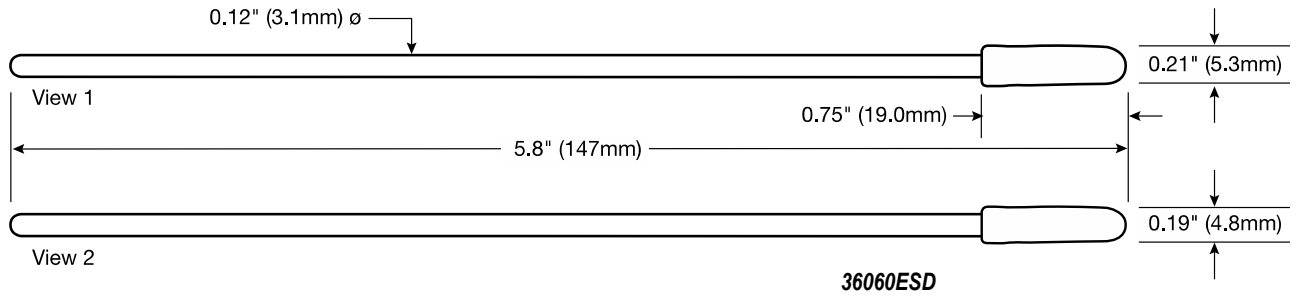
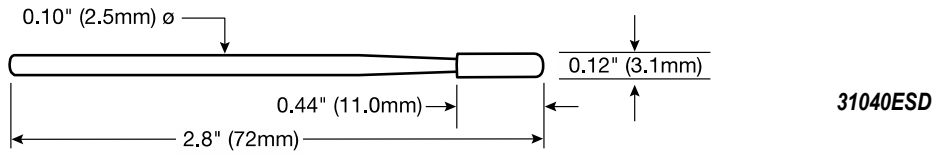

Sealed Foam ESD Swabs

- 100 pores per inch medical grade foam
- Traps surface particles while cleaning
- High solvent capacity; holds solvent well
- Fiberless construction does not generate loose fibers or particles
- Foam is thermally bonded to the swab; no adhesives or binders are used

41050ESD	2.8" (7.2 cm) blue handle, 0.13" (3.3 mm) foam head, 500/ bag
44070ESD	3.2" (8.0 cm) blue handle, soft point conical foam head, 0.11" (2.7 mm) at base, 0.03" (0.76 mm) at tip, 500/ bag
44070SDC	3.2" (8.0 cm) clear handle, stiff point conical foam head, 0.11" (2.7 mm) at base, 0.03" (0.76 mm) at tip, 500/ bag
48040ESD	2.7" (6.9 cm) blue handle, 0.12" (3.0 mm) foam head, 500/ bag
49250ESD	5.75" (14.5 cm) blue handle, 0.47" (12.0 mm) foam head, 500/ bag
49285CLR	6.5" (16.5 cm) clear handle, 0.32" (6.5 mm) foam head, 500/ bag

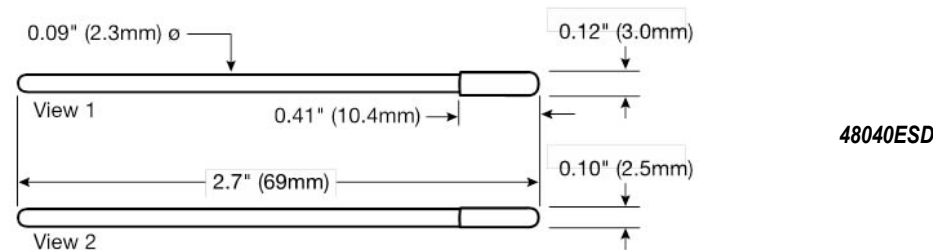
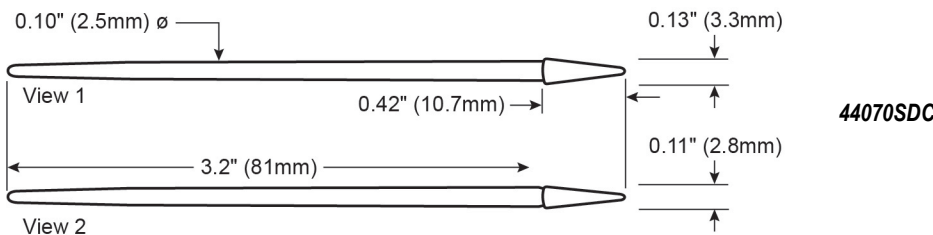
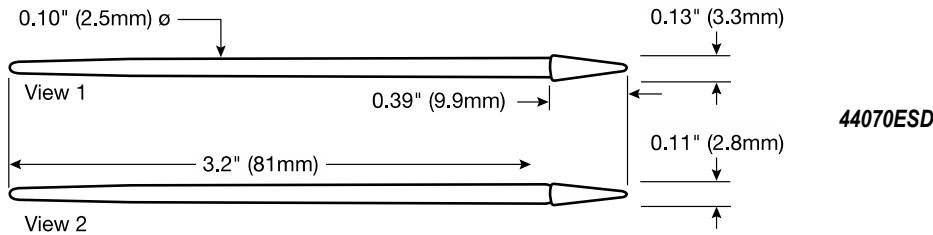
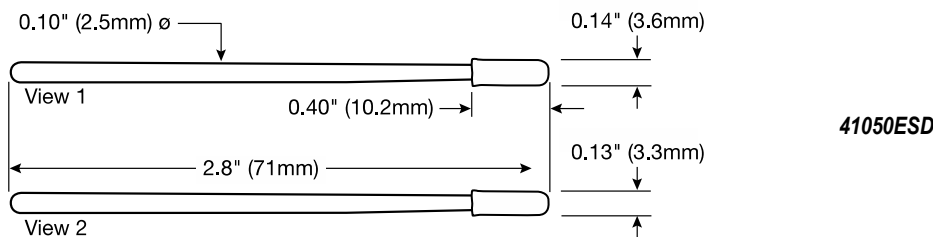

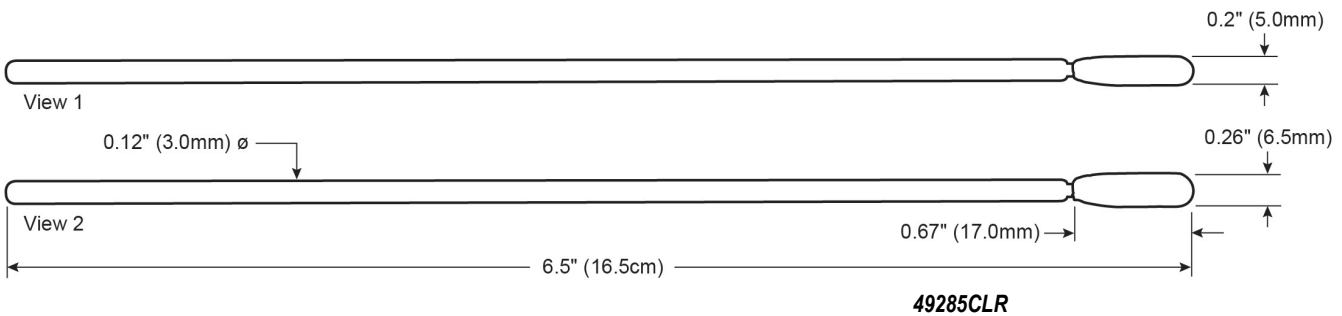
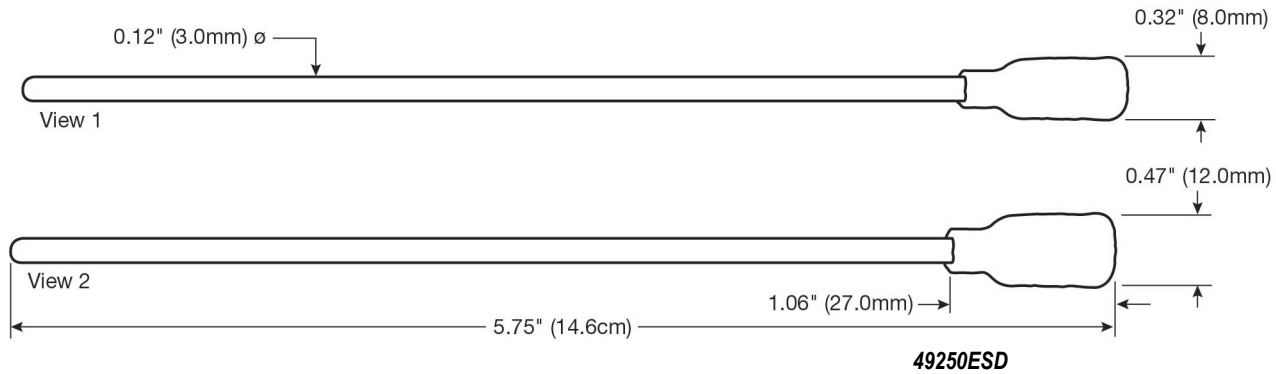

Wrapped Foam ESD Swab

- Excellent wicking action draws soils and solvent away from surfaces
- Stronger head than other foam swabs
- Fiberless construction does not generate loose fibers or particles
- No adhesives or binders are used in the construction

21050ESD

2.8" (7.1 cm) blue handle,
0.14" (3.7 mm) foam head, 500/ bag

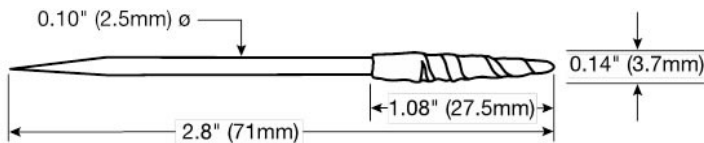

21050ESD

Polyester Pillow-Tip ESD Swab

- No edge seamless head design on all swabs
- High strength, durable head
- Low particulate and nonvolatile residue contamination
- No adhesives or binders are used in the construction
- Excellent solvent compatibility
- High solvent capacity

51121ESD

2.8" (7.1 cm) blue handle,
0.25" (6.5 mm) polyester head, 500/ bag

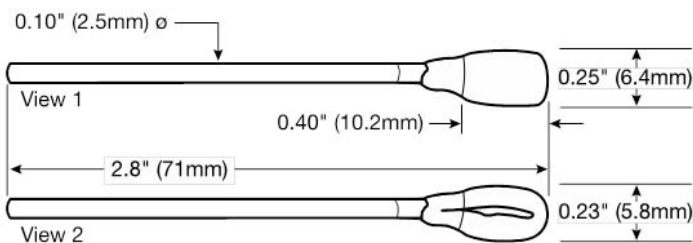

51121ESD

ESD Swabs - Sample Test Data

Swabs:	21050ESD	36060ESD	41050ESD	44070ESD	48040ESD	51121ESD
Particle Counts:						
0.5 - 1 um	755	685	571	1,867	797	3,463
1.0 - 2 um	97	189	96	336	230	1,605
2.0 - 5 um	20	58	37	71	66	206
5.0 - 10 um	7	30	31	31	24	29
10 - 25 um	13	19	19	15	11	14
Over 25 um	3	9	9	2	2	23
TOTAL	895	990	762	2,322	1,130	5,340
NVR (ug/swab)	none	none	none		none	none
Chlorides (ug/swab)	2	none	1	0.21	none	3

The swabs were tested by Particle Measurement Technology. All the swabs tests were done using the recommended practices of the Institute of Environmental Science, Swabs and Wipes Working Group.

	ESD Handles - Blue	ESD Handles - Clear
Surface Resistivity	10 ¹⁰ ohms/sq	10 ¹⁰ ohms/sq
Material	Polypropylene / Static Dissipative Copolymer Blend	ABS / Static Dissipative Copolymer Blend

The ESD handles do not contain silicone, amides, or static dissipative coatings. The proprietary copolymer blend is not humidity dependent. The handles have excellent chemical compatibility, even in acetone.

Technical and Application Assistance

Chemtronics provides a technical hotline to answer your technical and application related questions.

The toll free number is: 1-800-TECH-401

Note:

This information is believed to be accurate. It is intended for professional end users having the skills to evaluate and use the data properly. CHEMTRONICS does not guarantee the accuracy of the data and assumes no liability in connection with damages incurred while using it.

Chemtronics® is a registered trademark of Chemtronics. All rights reserved. Coventry™ and Aqua-Prime™ are trademarks of Chemtronics. All rights reserved.