

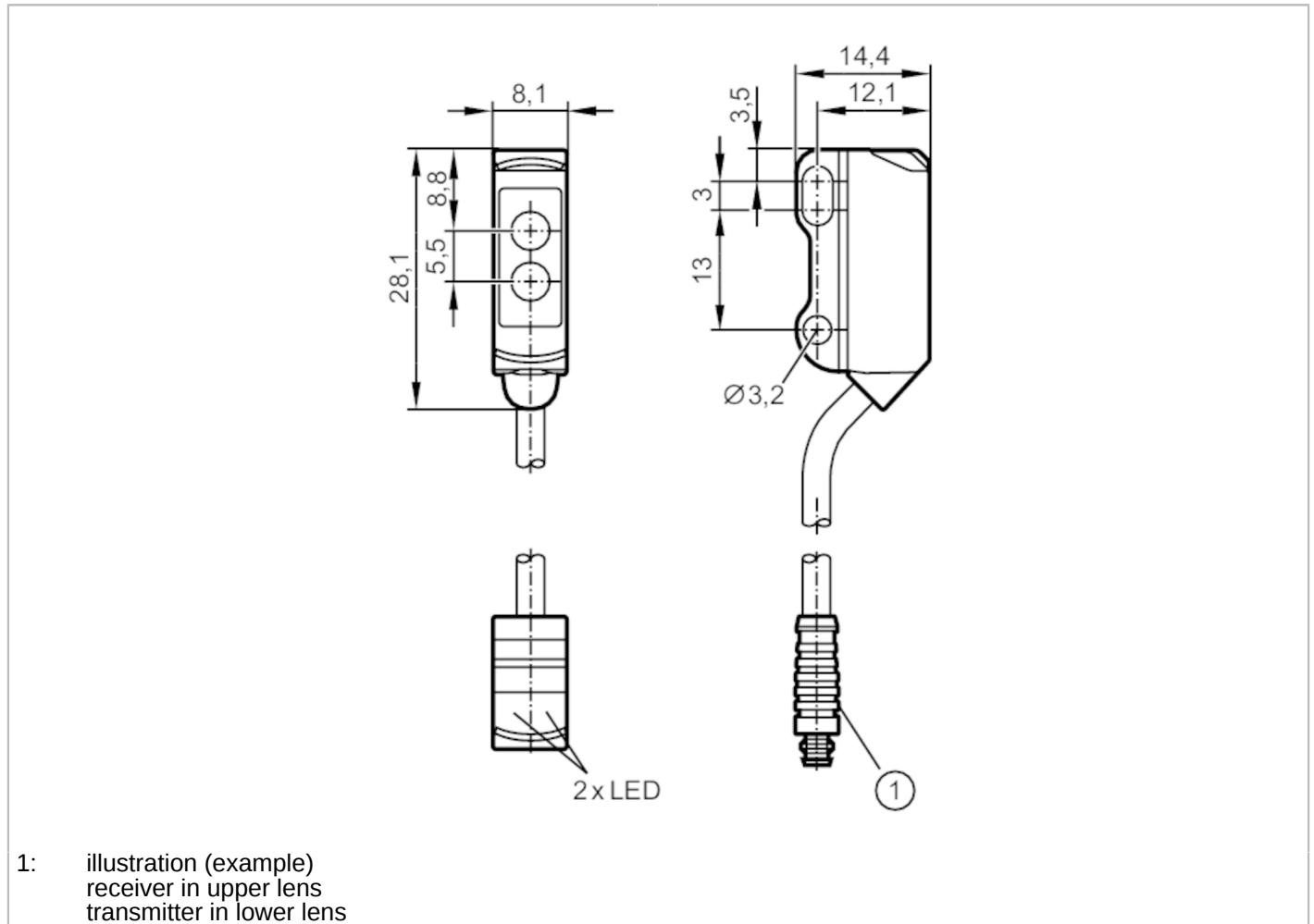

Diffuse reflection sensor with background suppression

O8H-HPKG/IO-Link/0,30M/AS/3P



Product characteristics	
Type of light	red light
Communication interface	IO-Link
Housing	rectangular
Dimensions [mm]	28.1 x 8.1 x 14.4
Application	
Special feature	Background suppression
Function principle	Diffuse reflection sensor
Electrical data	
Operating voltage [V]	10...30 DC
Current consumption [mA]	20; ((24 V))
Protection class	III
Reverse polarity protection	yes
Type of light	red light
Wave length [nm]	633



Diffuse reflection sensor with background suppression

O8H-HPKG/IO-Link/0,30M/AS/3P

Outputs	
Electrical design	PNP
Output function	light-on mode
Max. voltage drop switching output DC [V]	2.5
Permanent current rating of switching output DC [mA]	100
Switching frequency DC [Hz]	1000
Short-circuit protection	yes
Type of short-circuit protection	pulsed
Detection zone	
Range [mm]	1...30; (white paper 200 x 200 mm)
Range on white object (90 % remission) [mm]	1...30
Range on grey object (18 % remission) [mm]	5...30
Range on black object (6 % remission) [mm]	5...29
Range adjustable	yes
Max. light spot diameter [mm]	4
Light spot dimensions refer to	at maximum range
Monitoring range final value [mm]	10...80
Background suppression available	yes
Interfaces	
Communication interface	IO-Link
Transmission type	COM2 (38.4 kBaud)
IO-Link revision	1.1
SDCI standard	IEC 61131-9
IO-Link device ID	535 d / 00 02 17 h
Profiles	Smart Sensor: Device Identification; Device Diagnosis; Teach Channel; Binary Data Channel
SIO mode	yes
Required master port type	A
Operating conditions	
Ambient temperature [°C]	-25...60
Protection	IP 65; IP 67
Tests / approvals	
EMC	EN 60947-5-2
MTTF [years]	757

O8H208



Diffuse reflection sensor with background suppression

O8H-HPKG/IO-Link/0,30M/AS/3P

Mechanical data

Weight	[g]	20.9
Housing		rectangular
Dimensions	[mm]	28.1 x 8.1 x 14.4
Materials		housing: ABS; stainless steel (1.4404 / 316L)
Lens material		PMMA
Lens alignment		side lens

Displays / operating elements

Display	switching status	1 x LED, yellow
	operation	1 x LED, green

Remarks

Pack quantity	1 pcs.
---------------	--------

Electrical connection

Cable: 0.3 m, PVC; 3 x 0.08 mm²

Connector: 1 x M8



Connection

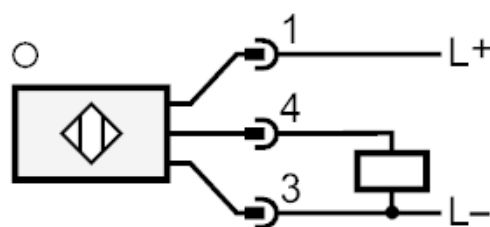



Diffuse reflection sensor with background suppression

O8H-HPKG/IO-Link/0,30M/AS/3P

Diagrams and graphs

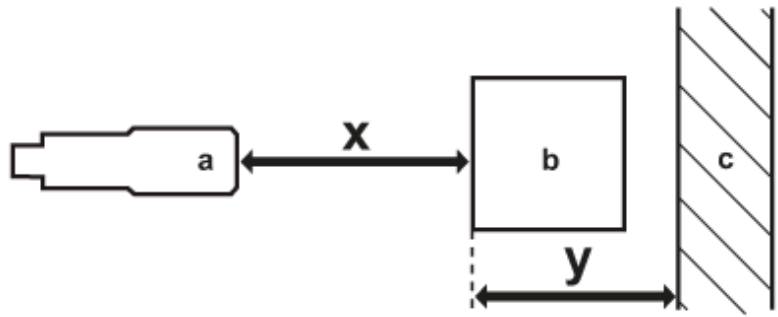

- a: sensor
- b: object
- c: background
- x: distance sensor/object [mm]
- y: min. distance object/background [mm]

accuracy graph

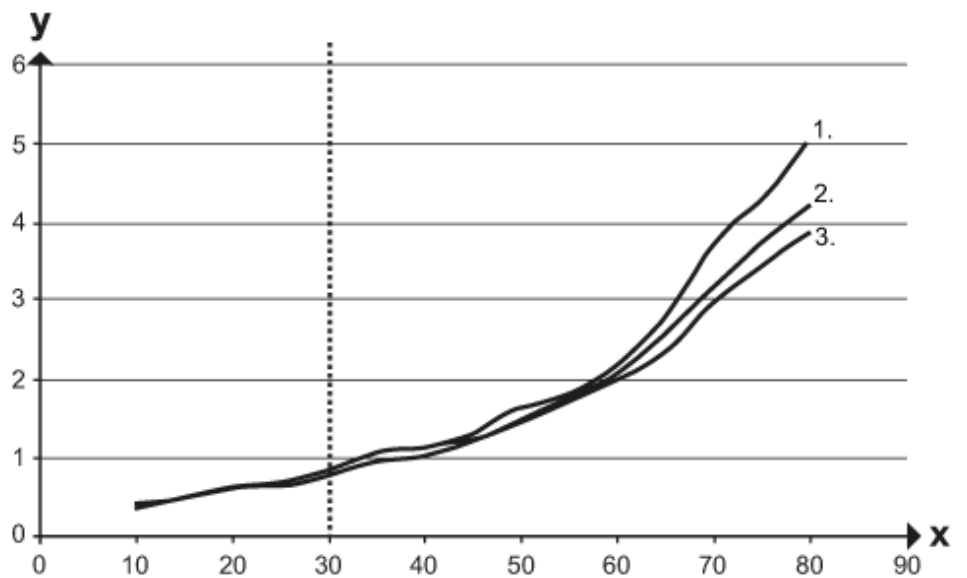

- x: distance sensor/object [mm]
- y: min. distance object/background [mm]
- 1 = object black (6 % remission) , background (white 90 % remission)
- 2 = object grey (18 % remission) , background (white 90 % remission)
- 3 = object white (90 % remission) , background (white 90 % remission)