

**M12 FEMALE 90°**

PUR 8x0,25 GRAY, drag ch 25m

M12

Female 90°

8-pole

Art.-No. 7005 - M12 Lite - (plastic hexagonal screw) on request

Plastic housings with good resistance against chemicals and oils. The resistance to aggressive media should be individually tested for your application. Further details on request. Further cable lengths on request.

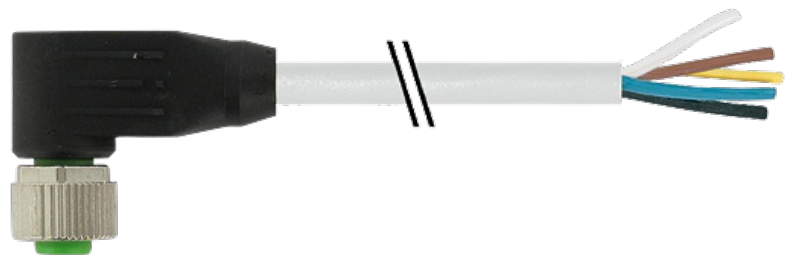
[Link to Product](#)**Illustration**

Female

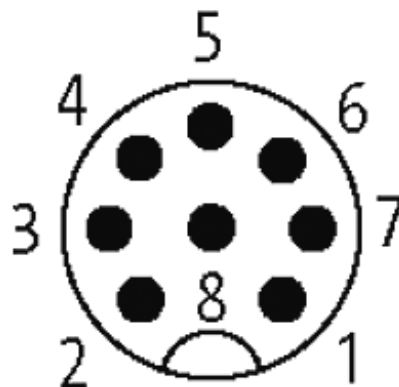

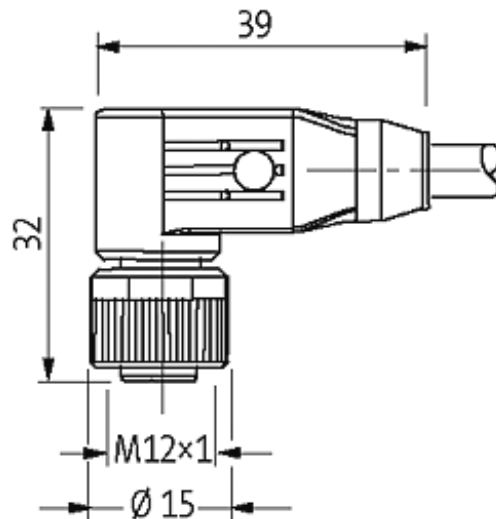

1	white
2	brown
3	green
4	yellow
5	gray
6	pink
7	blue
8	red

Product may differ from Image

### Approvals



\* only for products with UL/CSA approved cable

### Form

17061

### Technical Data

Operating voltage	max. 30 V AC/DC
Operating current per contact	max. 2 A
Locking of ports	Screw thread M12 × 1 mm (recommended torque 0.6 Nm) self-securing
Protection	IP67 inserted and tightened (EN 60529)

**Cables**

Cable number	292
No./diameter of wires	8 × 0.25 mm <sup>2</sup>
Wire isolation	PP (wh, br, gn, ye, gr, pk, bl, rd)
C-track properties	2 Mio.
Jacket Color	gray
Shore hardness outer jacket	85 ± 5A
Material (jacket)	PUR
Outer diameter	approx. 6.0 mm
Bend radius (fixed)	10 × outer Ø
Bend radius (moving)	15 × outer Ø
Temperature range (fixed)	-40...+80 °C
Temperature range (mobile)	-20...+80 °C

**Commercial data**

country of origin	DE
customs tariff number	85444290
minimum order quantity	1