

### 4 PIN DIP PHOTOTRANSISTOR PHOTOCOUPLER EL816 Series

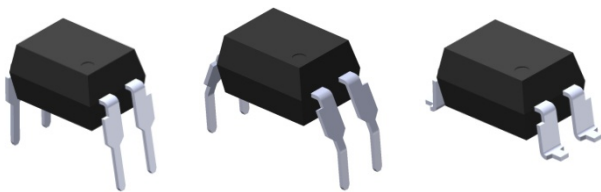

Schematic

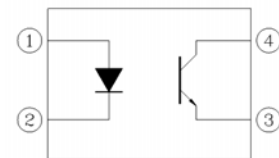

Pin Configuration

1. Anode
2. Cathode
3. Emitter
4. Collector

#### Features:

- Current transfer ratio  
(CTR: 50~600% at  $I_F = 5\text{mA}$ ,  $V_{CE} = 5\text{V}$ )  
(CTR: 63~320% at  $I_F = 10\text{mA}$ ,  $V_{CE} = 5\text{V}$ )
- High isolation voltage between inputs and output ( $V_{iso} = 5000\text{ V rms}$ )
- Creepage distance  $> 7.62\text{ mm}$
- Operating temperature up to  $+110^\circ\text{C}$
- Compact small outline package
- Pb free and RoHS compliant.
- UL approved (No. E214129)
- VDE approved (No. 132249)
- SEMKO approved
- NEMKO approved
- DEMKO approved
- FIMKO approved
- CSA approved

#### Description

The EL816 series of devices each consist of an infrared emitting diodes, optically coupled to a phototransistor detector. They are packaged in a 4-pin DIP package and available in wide-lead spacing and SMD option.

#### Applications

- Programmable controllers
- System appliances, measuring instruments
- Telecommunication equipments
- Home appliances, such as fan heaters, etc.
- Signal transmission between circuits of different potentials and impedances

**Absolute Maximum Ratings (Ta=25°C)**

	Parameter	Symbol	Rating	Unit
Input	Forward current	$I_F$	60	mA
	Peak forward current (1us, pulse)	$I_{FP}$	1	A
	Reverse voltage	$V_R$	6	V
	Power Dissipation No derating required up to $T_a = 100^\circ\text{C}$	$P_D$	100	mW
Output	Power dissipation Derating factor (above $T_a = 80^\circ\text{C}$ )	$P_C$	150 5.8	mW mW/°C
	Collector current	$I_C$	50	mA
	Collector-Emitter voltage	$V_{CEO}$	80	V
	Emitter-Collector voltage	$V_{ECO}$	6	V
	Total Power Dissipation	$P_{TOT}$	200	mW
Isolation Voltage*1	$V_{ISO}$	5000	V rms	
Operating Temperature	$T_{OPR}$	-55 to 110	°C	
Storage Temperature	$T_{STG}$	-55 to 125	°C	
Soldering Temperature*2	$T_{SOL}$	260	°C	

Notes:

\*1 AC for 1 minute, R.H.= 40 ~ 60% R.H. In this test, pins 1, 2 are shorted together, and pins 3, 4 are shorted together.

\*2 For 10 seconds

**Electro-Optical Characteristics (Ta=25°C unless specified otherwise)**

**Input**

Parameter	Symbol	Min.	Typ.	Max.	Unit	Condition
Forward Voltage	$V_F$	-	1.2	1.4	V	$I_F = 20\text{mA}$
Reverse Current	$I_R$	-	-	10	$\mu\text{A}$	$V_R = 4\text{V}$
Input capacitance	$C_{in}$	-	30	250	pF	$V = 0, f = 1\text{kHz}$

**Output**

Parameter	Symbol	Min	Typ.	Max.	Unit	Condition
Collector-Emitter dark current	$I_{CEO}$	-	-	100	nA	$V_{CE} = 20\text{V}, I_F = 0\text{mA}$
Collector-Emitter breakdown voltage	$BV_{CEO}$	80	-	-	V	$I_C = 0.1\text{mA}$
Emitter-Collector breakdown voltage	$BV_{ECO}$	6	-	-	V	$I_E = 0.1\text{mA}$

**Transfer Characteristics**

Parameter	Symbol	Min	Typ.	Max.	Unit	Condition	
Current Transfer ratio	EL816	50	-	600	%	$I_F = 5\text{mA}, V_{CE} = 5\text{V}$	
	EL816A	80	-	160			
	EL816B	130	-	260			
	EL816C	200	-	400			
	EL816D	300	-	600			
	EL816X	100	-	200			
	EL816Y	150	-	300			
	EL816I	63	-	125			$I_F = 10\text{mA}, V_{CE} = 5\text{V}$
	EL816J	100	-	200			
	EL816K	160	-	320			
	EL816I	22	-	-			
	EL816J	34	-	-			
	EL816K	56	-	-			$I_F = 1\text{mA}, V_{CE} = 5\text{V}$

**Transfer Characteristics ( $T_a=25^{\circ}\text{C}$  unless specified otherwise) Continuity**

Parameter	Symbol	Min	Typ.	Max.	Unit	Condition
Collector-Emitter saturation voltage	$V_{CE(sat)}$	-	0.1	0.2	V	$I_F = 20\text{mA}, I_C = 1\text{mA}$
Isolation resistance	$R_{IO}$	$5 \times 10^{10}$	-	-	$\Omega$	$V_{IO} = 500\text{Vdc}$ , 40~60% R.H.
Floating capacitance	$C_{IO}$	-	0.6	1.0	pF	$V_{IO} = 0, f = 1\text{MHz}$
Cut-off frequency	$f_c$	-	80	-	kHz	$V_{CE} = 5\text{V}, I_C = 2\text{mA}$ $R_L = 100\Omega, -3\text{dB}$
Rise time	$t_r$	-	4	18	$\mu\text{s}$	$V_{CE} = 2\text{V}, I_C = 2\text{mA}$ , $R_L = 100\Omega$
Fall time	$t_f$	-	3	18	$\mu\text{s}$	

\* Typical values at  $T_a = 25^{\circ}\text{C}$

Typical Electro-Optical Characteristics Curves

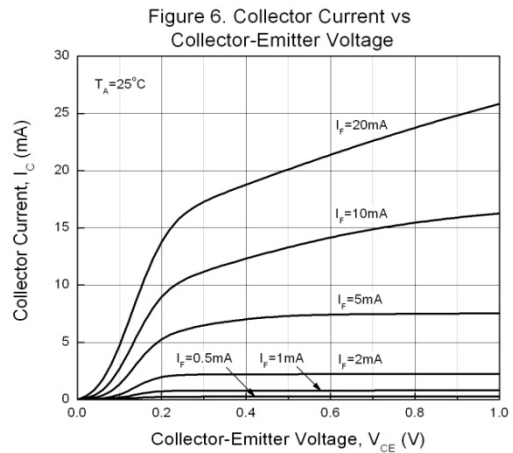
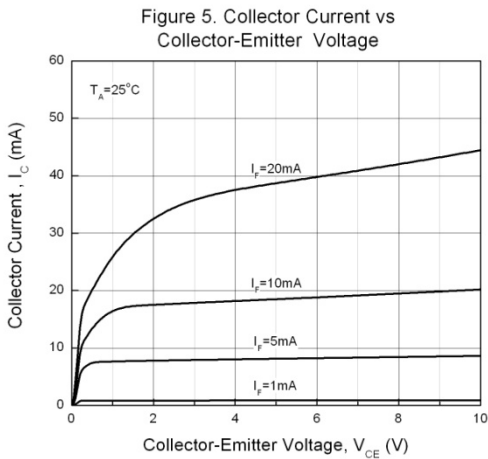
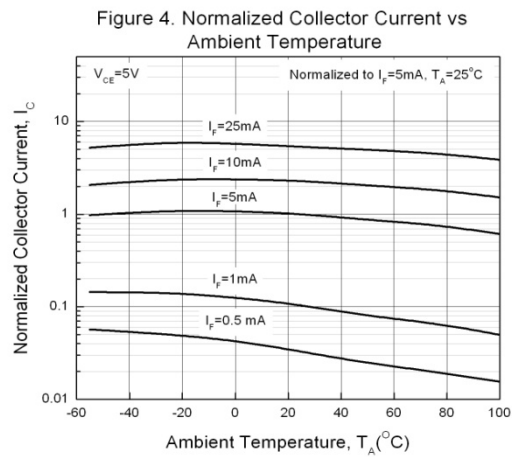
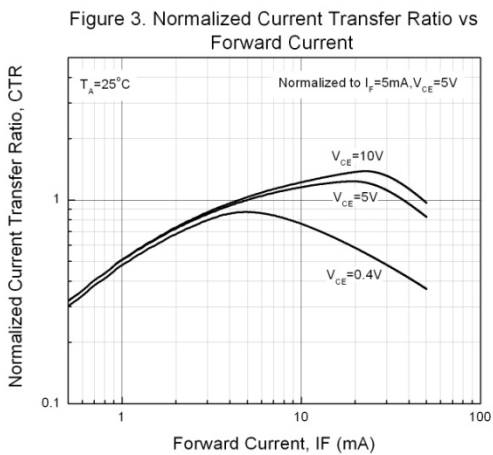
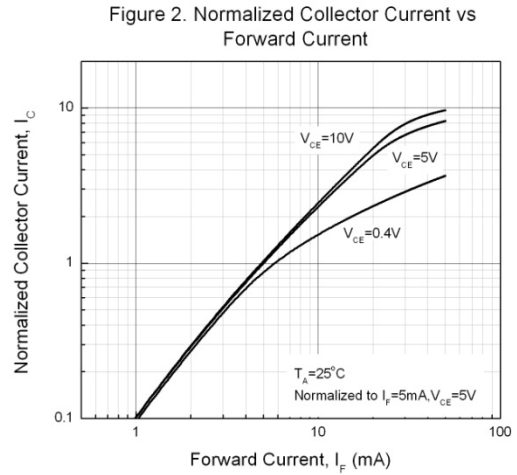
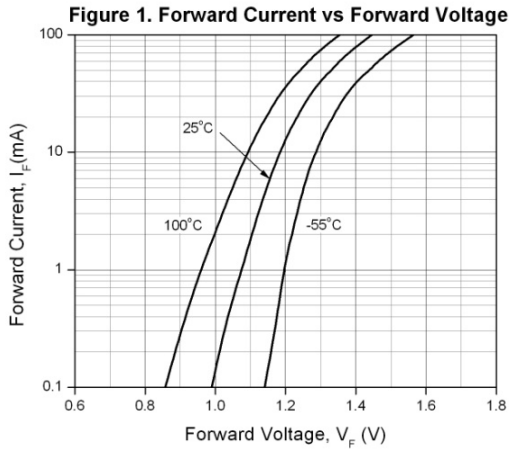

Figure 7. Collector Dark Current vs Ambient Temperature

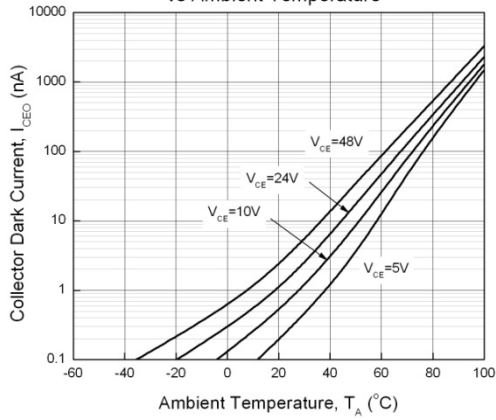

Figure 8. Switching Time vs Load Resistance

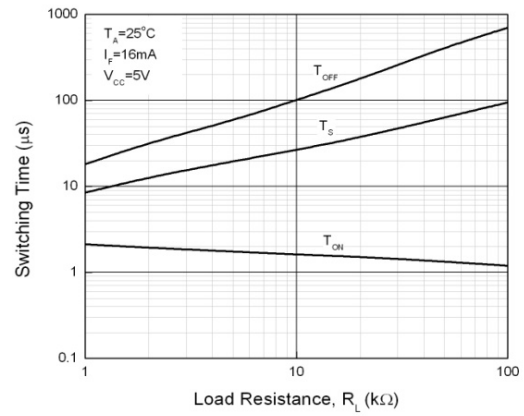

Figure 9. Collector-Emitter Saturation Voltage vs Ambient Temperature

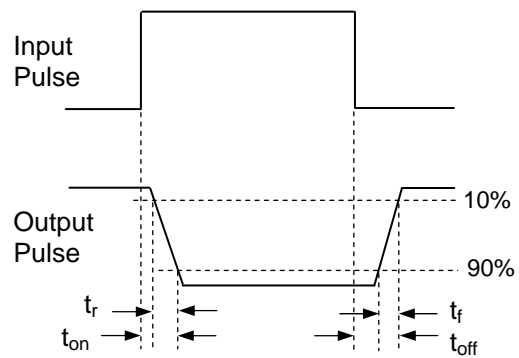
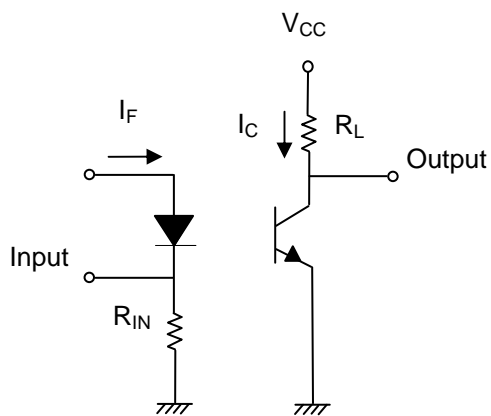
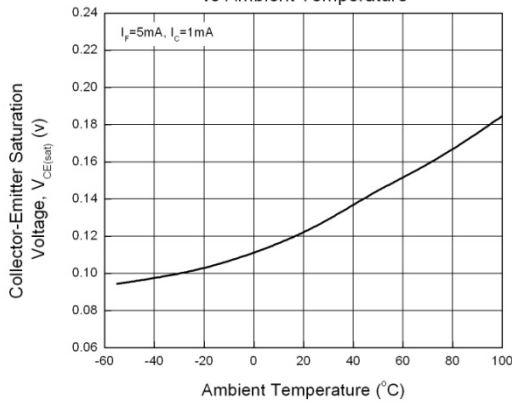

Figure 10. Switching Time Test Circuit & Waveforms

**Order Information**

**Part Number**

**EL816X(Y)(Z)-FV**

**Note**

- X = Lead form option (S, S1, S2, M or none)
- Y = CTR Rank (A, B, C, D, X, Y, I, J, K or none)
- Z = Tape and reel option (TA, TB, TU, TD or none).
- F = Lead frame option (F: Iron, None: copper)
- V = VDE safety (optional).

Option	Description	Packing quantity
None	Standard DIP-4	100 units per tube
M	Wide lead bend (0.4 inch spacing)	100 units per tube
S (TA)	Surface mount lead form + TA tape & reel option	1000 units per reel
S (TB)	Surface mount lead form + TB tape & reel option	1000 units per reel
S1 (TA)	Surface mount lead form (low profile) + TA tape & reel option	1000 units per reel
S1 (TB)	Surface mount lead form (low profile) + TB tape & reel option	1000 units per reel
S2 (TA)	Surface mount lead form (Gull-wing) + TA tape & reel option	1000 units per reel
S2 (TB)	Surface mount lead form (Gull-wing) + TB tape & reel option	1000 units per reel
S (TU)	Surface mount lead form + TU tape & reel option	1500 units per reel
S (TD)	Surface mount lead form + TD tape & reel option	1500 units per reel
S1 (TU)	Surface mount lead form (low profile) + TU tape & reel option	1500 units per reel
S1 (TD)	Surface mount lead form (low profile) + TD tape & reel option	1500 units per reel

**Package Dimension (Dimensions in mm)**

**Standard DIP Type**

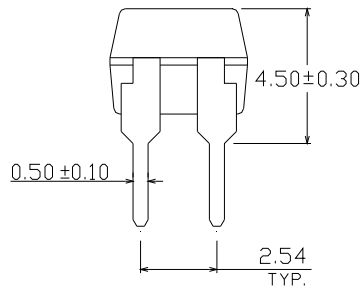
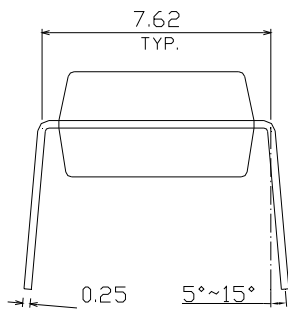
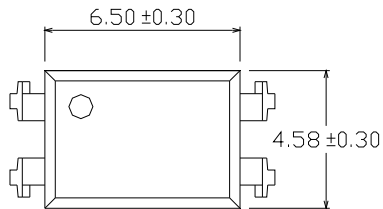

**Option M Type**

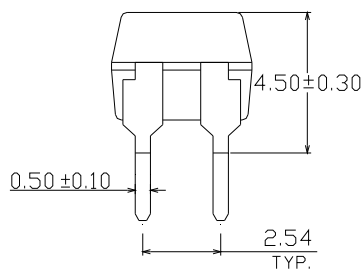
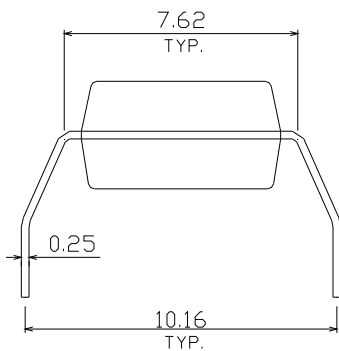
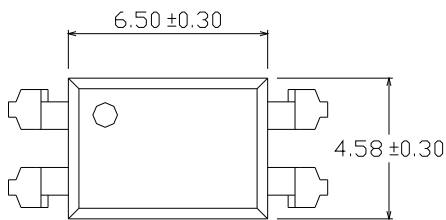



Option S Type

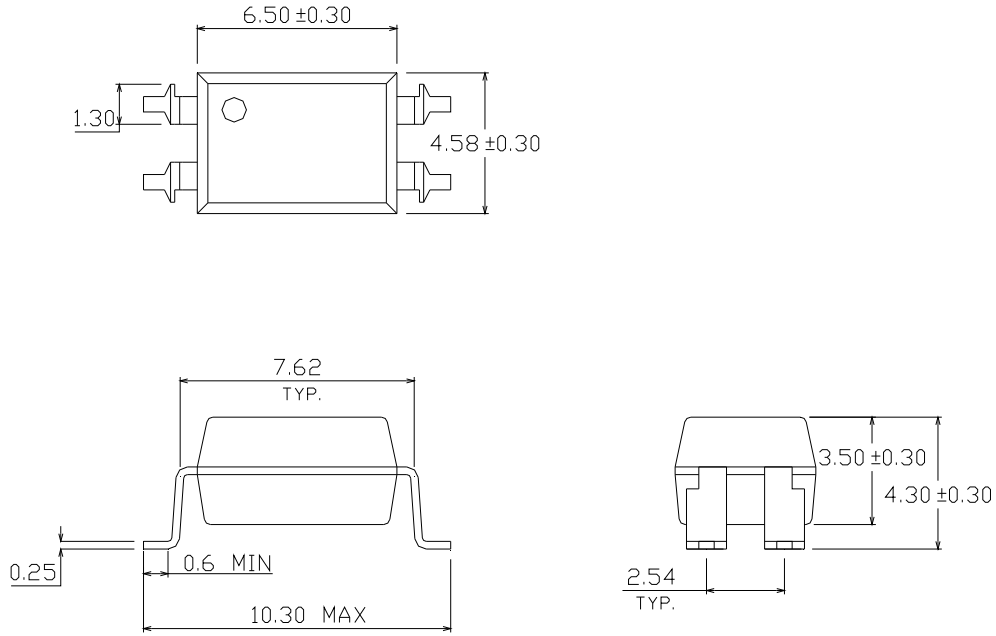

Option S1 Type

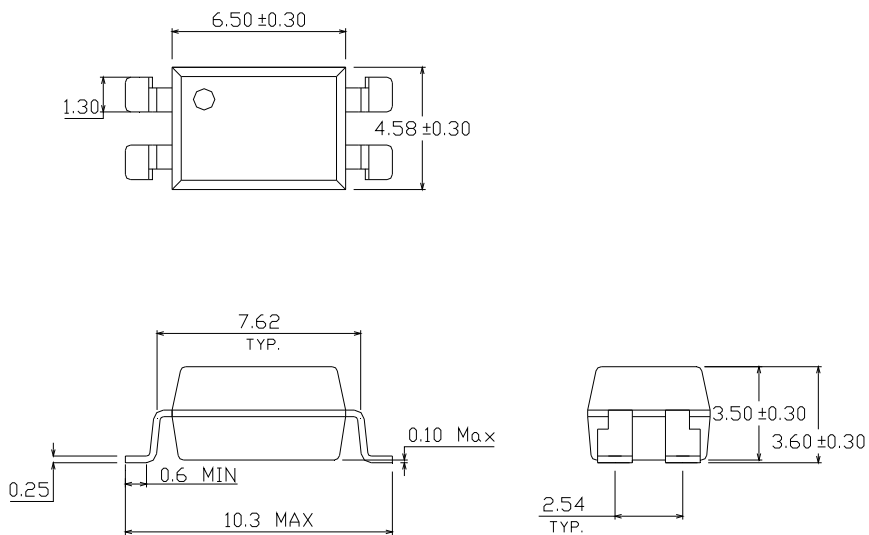

**Option S2 Type**

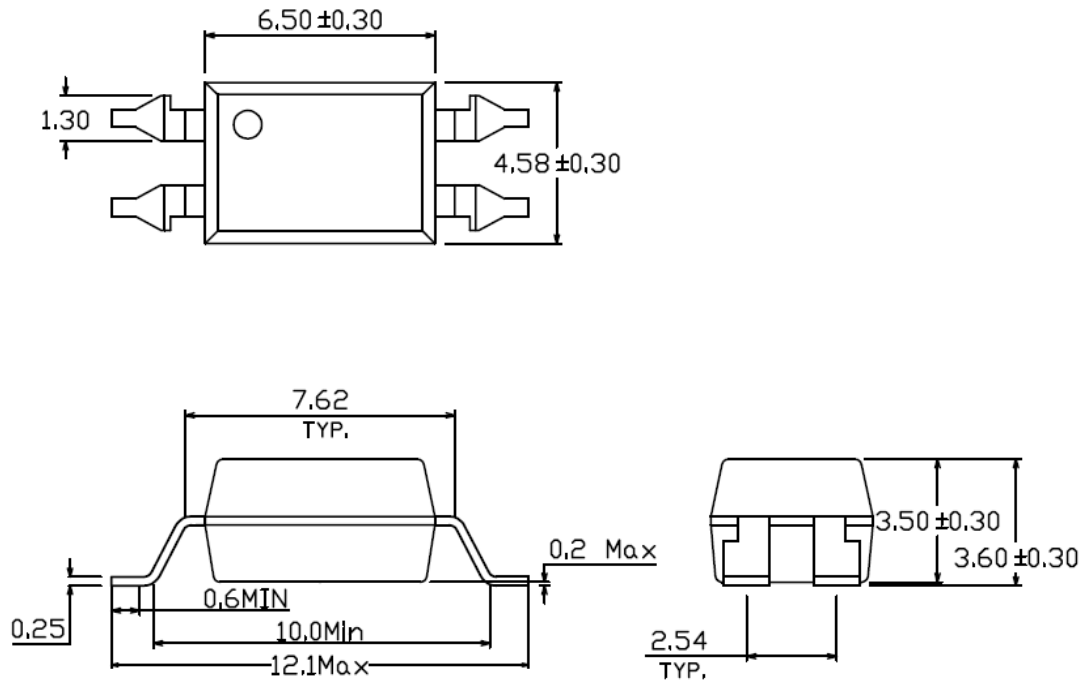

**Recommended pad layout for surface mount leadform**

**For S and S1 option**

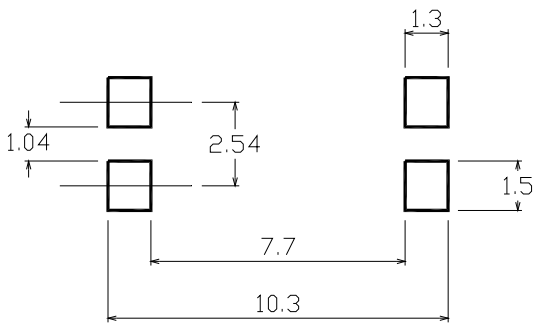

**For S2 option**

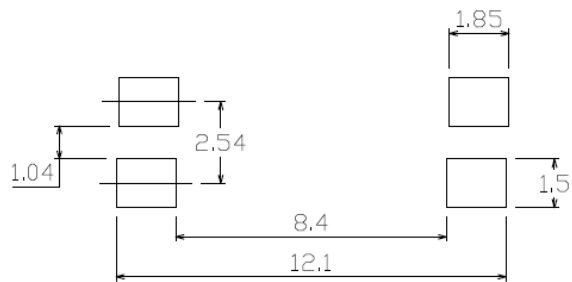

## Device Marking

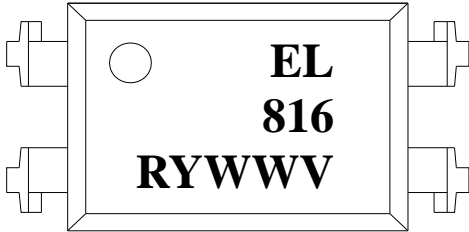

## Notes

EL	denotes EVERLIGHT
816	denotes Device Number
R	denotes CTR Rank
Y	denotes 1 digit Year code
WW	denotes 2 digit Week code
V	denotes VDE (optional)

### Tape & Reel Packing Specifications

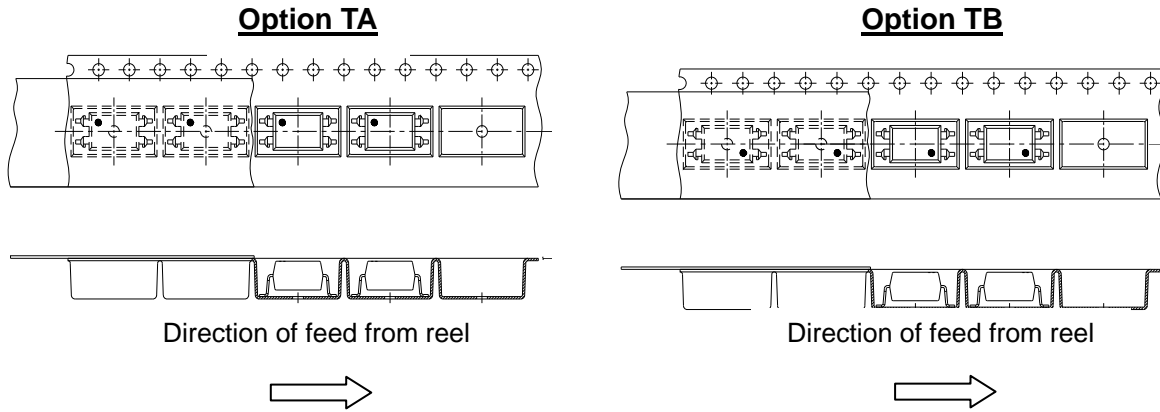

### Tape dimensions

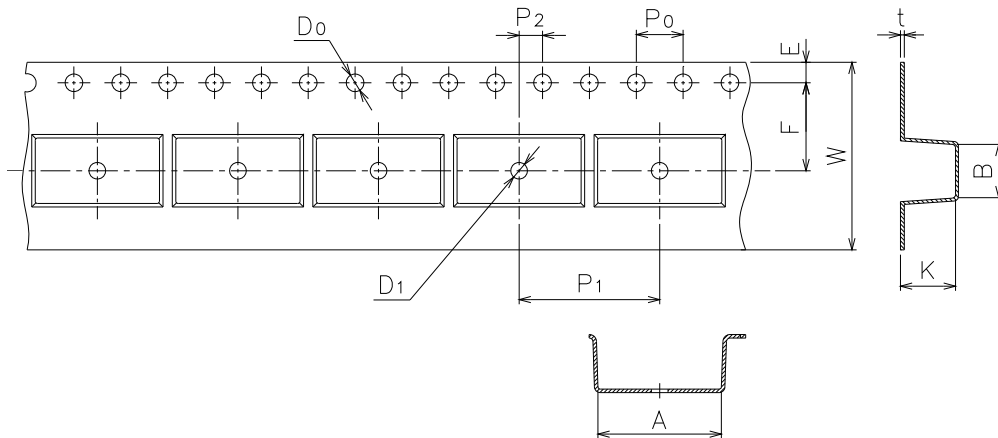

### Tape dimensions

Dimension No.	<b>A</b>	<b>B</b>	<b>Do</b>	<b>D1</b>	<b>E</b>	<b>F</b>
Dimension (mm)	10.5±0.1	4.65±0.1	1.55±0.1	1.50±0.1	1.75±0.1	7.5±0.1
Dimension (mm) S2	12.15±0.1	4.65±0.1	1.55±0.1	1.50±0.1	1.75±0.1	7.5±0.1
Dimension No.	<b>Po</b>	<b>P1</b>	<b>P2</b>	<b>t</b>	<b>W</b>	<b>K</b>
Dimension (mm)	4.0±0.1	12.0±0.1	2.0±0.1	0.35±0.1	16.0±0.3	4.75±0.1
Dimension (mm) S2	4.0±0.1	16.0±0.1	2.0±0.1	0.35±0.1	16.0±0.3	3.90±0.1

**Option TD**

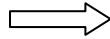
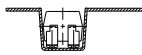
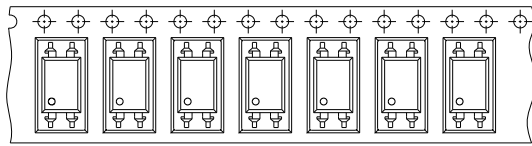

Direction of feed from reel

**Option TU**

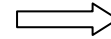
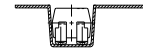
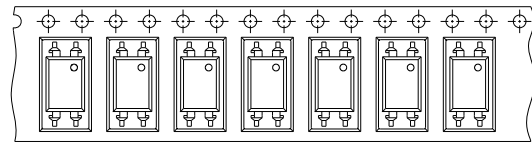

Direction of feed from reel

**Tape dimensions**

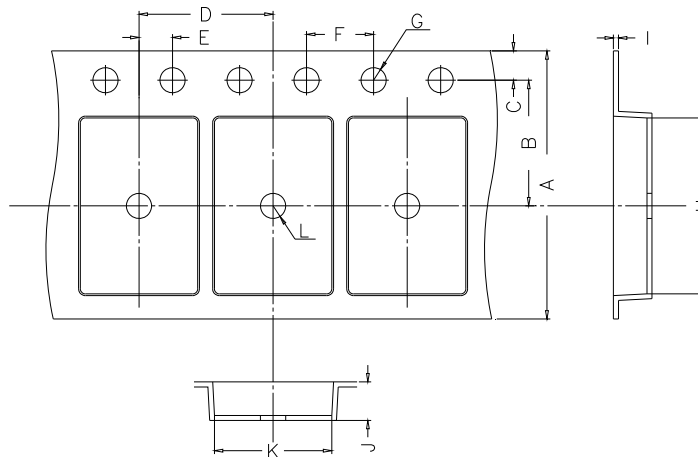

Dimension No.	<b>A</b>	<b>B</b>	<b>C</b>	<b>D</b>	<b>E</b>	<b>F</b>
Dimension(mm)	16.00±0.3	7.5±0.1	1.75±0.1	8.0±0.1	2.0±0.1	4.0±0.1
Dimension No.	<b>G</b>	<b>H</b>	<b>I</b>	<b>J</b>	<b>K</b>	<b>L</b>
Dimension(mm)	1.55±0.05	10.4±0.1	0.4±0.05	4.60±0.1	5.1±0.1	1.55±0.05

## Precautions for Use

### 1. Soldering Condition

#### 1.1 (A) Maximum Body Case Temperature Profile for evaluation of Reflow Profile

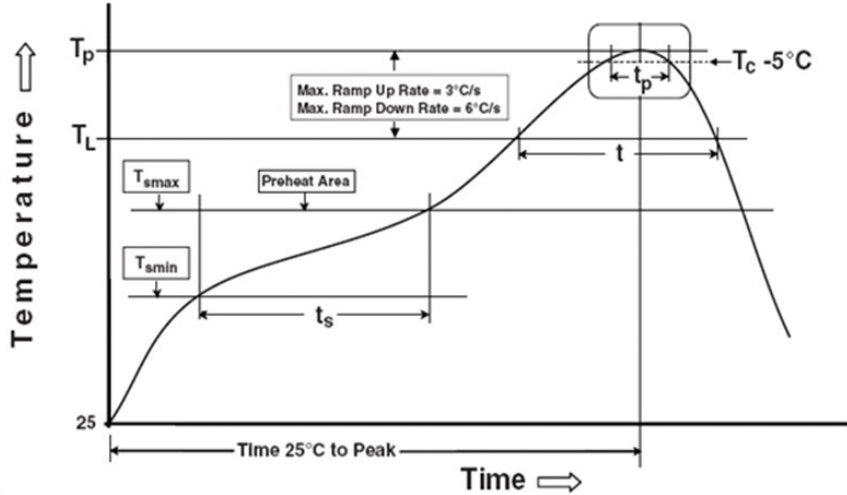

Note:

Reference: IPC/JEDEC J-STD-020D

#### Preheat

Temperature min ( $T_{smin}$ )	150 °C
Temperature max ( $T_{smax}$ )	200°C
Time ( $T_{smin}$ to $T_{smax}$ ) ( $t_s$ )	60-120 seconds
Average ramp-up rate ( $T_{smax}$ to $T_p$ )	3 °C/second max

#### Other

Liquidus Temperature ( $T_L$ )	217 °C
Time above Liquidus Temperature ( $t_L$ )	60-100 sec
Peak Temperature ( $T_p$ )	260°C
Time within 5 °C of Actual Peak Temperature: $T_p - 5^\circ\text{C}$	30 s
Ramp- Down Rate from Peak Temperature	6°C /second max.
Time 25°C to peak temperature	8 minutes max.
Reflow times	3 times

## **DISCLAIMER**

1. Above specification may be changed without notice. EVERLIGHT will reserve authority on material change for above specification.
2. When using this product, please observe the absolute maximum ratings and the instructions for using outlined in these specification sheets. EVERLIGHT assumes no responsibility for any damage resulting from use of the product which does not comply with the absolute maximum ratings and the instructions included in these specification sheets.
3. These specification sheets include materials protected under copyright of EVERLIGHT corporation. Please don't reproduce or cause anyone to reproduce them without EVERLIGHT's consent.