

# E20429

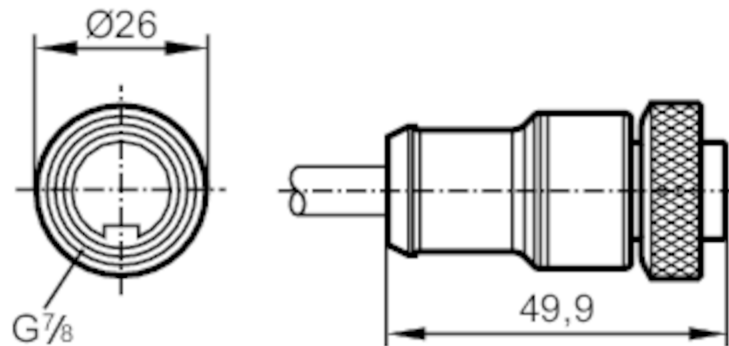

## Connecting cable with socket

AD0GB030PLS0005E03



### Electrical data

Operating voltage [V] < 250 AC

### Operating conditions

Ambient temperature [°C] -40...80

Protection IP 68

### Mechanical data

Weight [g] 279.3

Dimensions [mm] 26 x 26 x 49.9

Materials TPU

Material nut diecast zinc, nickel-plated

### Remarks

Pack quantity 1 pcs.

### Electrical connection

Cable: 5 m, PVC, black, Ø 5.2 mm; 3 x 0.75 mm<sup>2</sup> (24 x Ø 0.2 mm )

### Electrical connection - socket

Connector: 1 x 7/8", straight; Moulded body: TPU; Locking: diecast zinc, nickel-plated

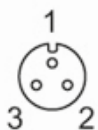

# E20429



## Connecting cable with socket

AD0GB030PLS0005E03

### Connection

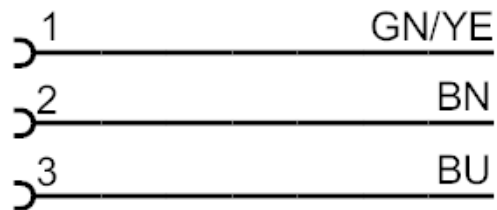

Core colours :

BN = brown

BU = blue

GN/YE = green/yellow