

**MHS 5/02 H T3 B T****Weidmüller Interface GmbH & Co. KG**

Klingenbergstraße 26

D-32758 Detmold

Germany

www.weidmueller.com

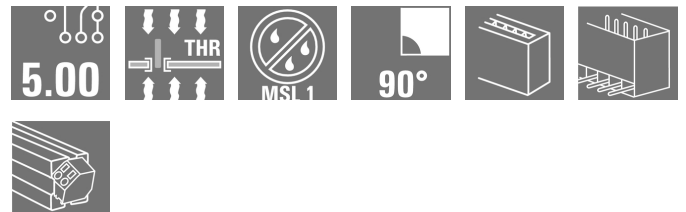
**Product image**

Configurable connector portfolio with fast and safe SNAP IN connection technology. The modular slice concept allows different hybrid combinations out of signal, data and power in one. The future-proof system is suitable for the highest requirements of the digital and connected world.

**General ordering data**

Order No.	<a href="#">274140000</a>
Type	MHS 5/02 H T3 B T
GTIN (EAN)	4064675055389
Qty.	48 pc(s).
Product data	IEC: 400 V / 26.8 A UL: 300 V / 18.5 A
Packaging	Tube

Creation date 11 February 2021 05:33:12 CET

Catalogue status 29.01.2021 / We reserve the right to make technical changes.

## MHS 5/02 H T3 B T

Weidmüller Interface GmbH &amp; Co. KG

Klingenbergstraße 26

D-32758 Detmold

Germany

www.weidmueller.com

## Technical data

## Dimensions and weights

Depth	14 mm	Depth (inches)	0.551 inch
Height	15.1 mm	Height (inches)	0.594 inch
Height of lowest version	11.9 mm	Net weight	1.801 g
Weight	1.78 g	Width	11.4 mm
Width (inches)	0.449 inch		

## System specifications

Type of connection	Board connection	Mounting onto the PCB	THT/THR solder connection
Pitch in mm (P)	5 mm	Pitch in inches (P)	0.197 inch
Outgoing elbow	90°	Number of poles	2
Number of solder pins per pole	1	Solder pin length (l)	3.2 mm
Solder pin dimensions	1.0 x 1.0 mm	Solder eyelet hole diameter (D)	1.4 mm
Solder eyelet hole diameter tolerance (D)+ 0,1 mm		Outside diameter of solder pad	2.3 mm
Template aperture diameter	2.1 mm	L1 in mm	5 mm
L1 in inches	0.197 inch	Number of rows	1
Pin series quantity	1	Touch-safe protection acc. to DIN VDE 57 106	Touch-safe above the printed circuit board
Touch-safe protection acc. to DIN VDE 0470	IP 20	Volume resistance	≤5 mΩ
Plugging force/pole, max.	8.5 N	Pulling force/pole, max.	8.5 N

## Material data

Insulating material	PA 9T	Colour	black
Colour chart (similar)	RAL 9011	Insulating material group	I
Comparative Tracking Index (CTI)	≥ 600	Moisture Level (MSL)	1
UL 94 flammability rating	V-0	Contact base material	CuMg
Contact material	CuMg	Contact surface	tinned
Tinning type	matt	Layer structure of solder connection	1...3 μm Ni / 2...4 μm Sn matt
Layer structure of plug contact	1...3 μm Ni / 2...4 μm Sn matt	Storage temperature, min.	-25 °C
Storage temperature, max.	55 °C	Operating temperature, min.	-50 °C
Operating temperature, max.	100 °C		

## Rated data acc. to IEC

tested acc. to standard	IEC 60664-1, IEC 61984	Rated current, min. number of poles (Tu=20°C)	26.8 A
Rated current, max. number of poles (Tu=20°C)	19.7 A	Rated current, min. number of poles (Tu=40°C)	23.1 A
Rated current, max. number of poles (Tu=40°C)	16.9 A	Rated voltage for surge voltage class / pollution degree II/2	400 V
Rated voltage for surge voltage class / pollution degree III/2	320 V	Rated voltage for surge voltage class / pollution degree III/3	250 V
Rated impulse voltage for surge voltage class/ pollution degree II/2	4 kV	Rated impulse voltage for surge voltage class/ pollution degree III/2	4 kV
Rated impulse voltage for surge voltage class/ contamination degree III/3	4 kV		

**Data sheet**

**MHS 5/02 H T3 B T**

**Weidmüller Interface GmbH & Co. KG**  
 Klingenbergstraße 26  
 D-32758 Detmold  
 Germany

www.weidmueller.com

**Technical data**

**Rated data acc. to UL 1059**

Institute (cURus)		Certificate No. (cURus)	E60693
Rated voltage (Use group B / UL 1059)	300 V	Rated voltage (Use group D / UL 1059)	300 V
Rated current (Use group B / UL 1059)	18.5 A	Rated current (Use group D / UL 1059)	10 A
Reference to approval values	Specifications are maximum values, details - see approval certificate.		

**Classifications**

ETIM 6.0	EC002637	ETIM 7.0	EC002637
ECLASS 9.0	27-44-04-02	ECLASS 9.1	27-44-04-02
ECLASS 10.0	27-44-04-02	ECLASS 11.0	27-46-02-01

**Important note**

IPC conformity	Conformity: The products are developed, manufactured and delivered according international recognized standards and norms and comply with the assured properties in the data sheet resp. fulfill decorative properties in accordance with IPC-A-610 "Class 2". Further claims on the products can be evaluated on request.
Notes	<ul style="list-style-type: none"> <li>• Rated current related to rated cross-section &amp; min. No. of poles.</li> <li>• P on drawing = pitch</li> <li>• Rated data refer only to the component itself. Clearance and creepage distances to other components are to be designed in accordance with the relevant application standards.</li> <li>• Diameter of solder eyelet D = 1.4+0.1mm</li> </ul>

**Approvals**

Approvals	
UL File Number Search	E60693

**Downloads**

Engineering Data	<a href="#">STEP</a>
------------------	----------------------

**MHS 5/02 H T3 B T**

**Weidmüller Interface GmbH & Co. KG**  
 Klingenbergstraße 26  
 D-32758 Detmold  
 Germany

[www.weidmueller.com](http://www.weidmueller.com)

**Drawings**

**Product image**

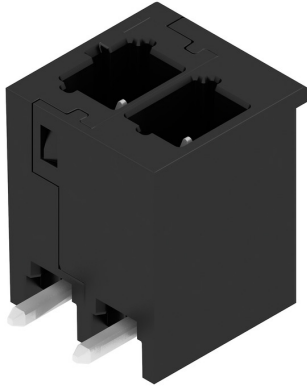

**Dimensional drawing**

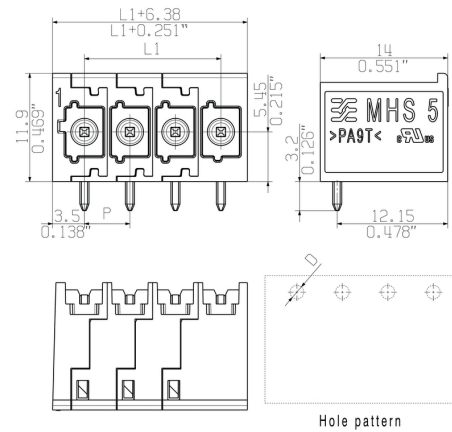

Allgemeingültige Kundenzeichnung, aktueller Stand nur auf Anfrage  
 General customer drawing, topical version only if required

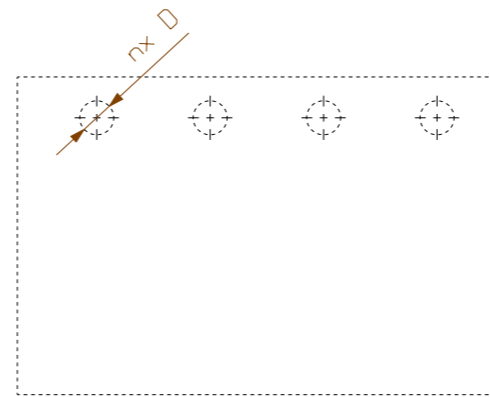
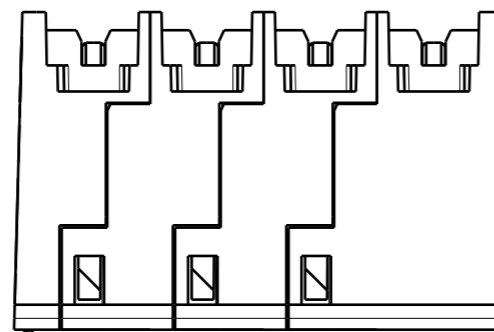
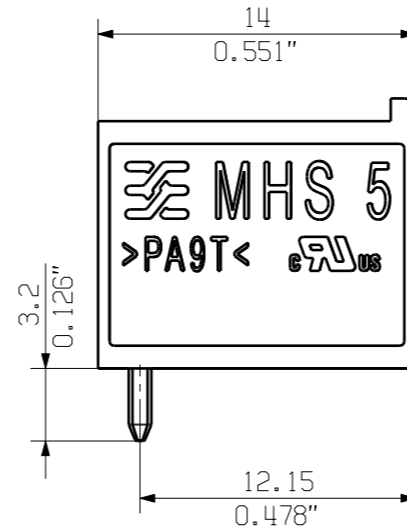
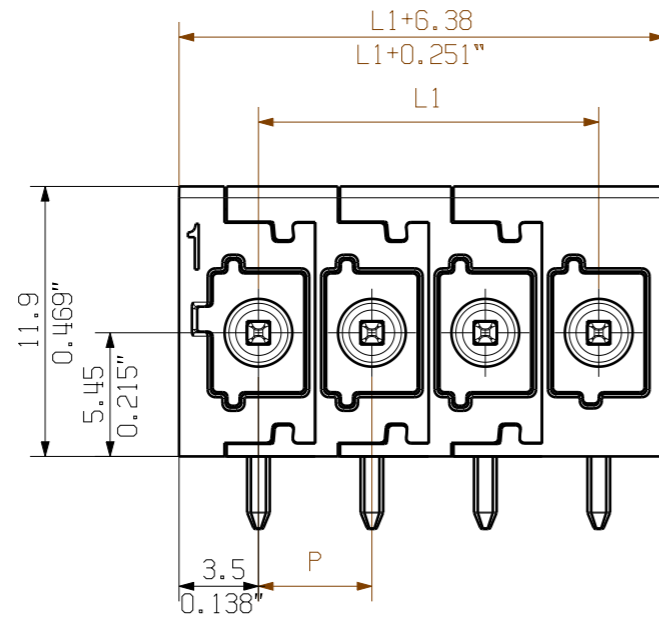

Hole pattern

12	55.00	2.165
11	50.00	1.969
10	45.00	1.772
9	40.00	1.575
8	35.00	1.378
7	30.00	1.181
6	25.00	0.984
5	20.00	0.787
4	15.00	0.591
3	10.00	0.394
2	5.00	0.197
n Poles	L1 [mm]	L1 [inch]

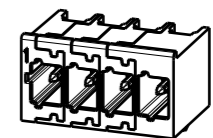

M 1/1

For the mounting of PCBs, it should be noted that the rated data relates only to the PCB components alone.

The necessary creepage and clearance paths must be observed in connection with the respective applicant in accordance to IEC 664 / VDE 0110. The current-carrying capacity and pitch tolerance is to be determined according to DIN IEC 326 part 3 very fine.

Weidmueller PCB components are tested according to the DIN EN 61984 or to the DIN EN 60947-7-4 standard, and are valid for its field of application. Provided that the components are used to the intended purpose, all requirements with respect to the occurring of electrical, mechanical, thermic and corrosive stress will be satisfied.

Further Dim. & Info. See data sheet

General tolerance:  
 DIN ISO 2768-mK

	EC00004370 P028441	Prim PLM Part No.: .		Prim ERP Part No.: .	
	First Issue Date 07.05.2020	Max. nos.			<b>72562</b> Drawing no. Issue no. Sheet 3 of 4 sheets
	Modification				
	Drawn	Date	Name		
	Responsible		Schmitz, Till		
	Approved	15.01.2021	Sapina, Svetos		
Scale: 3/1	Size: A3	Drawings Assembly		Product file:	

**MHS 5/... T3**  
 STIFTLISTE  
 MALE HEADER

## Recommended reflow soldering profile

**Weidmüller Interface GmbH & Co. KG**  
 Klingenbergstraße 16  
 D-32758 Detmold  
 Germany  
 Fon: +49 5231 14-0  
 Fax: +49 5231 14-292083  
 www.weidmueller.com

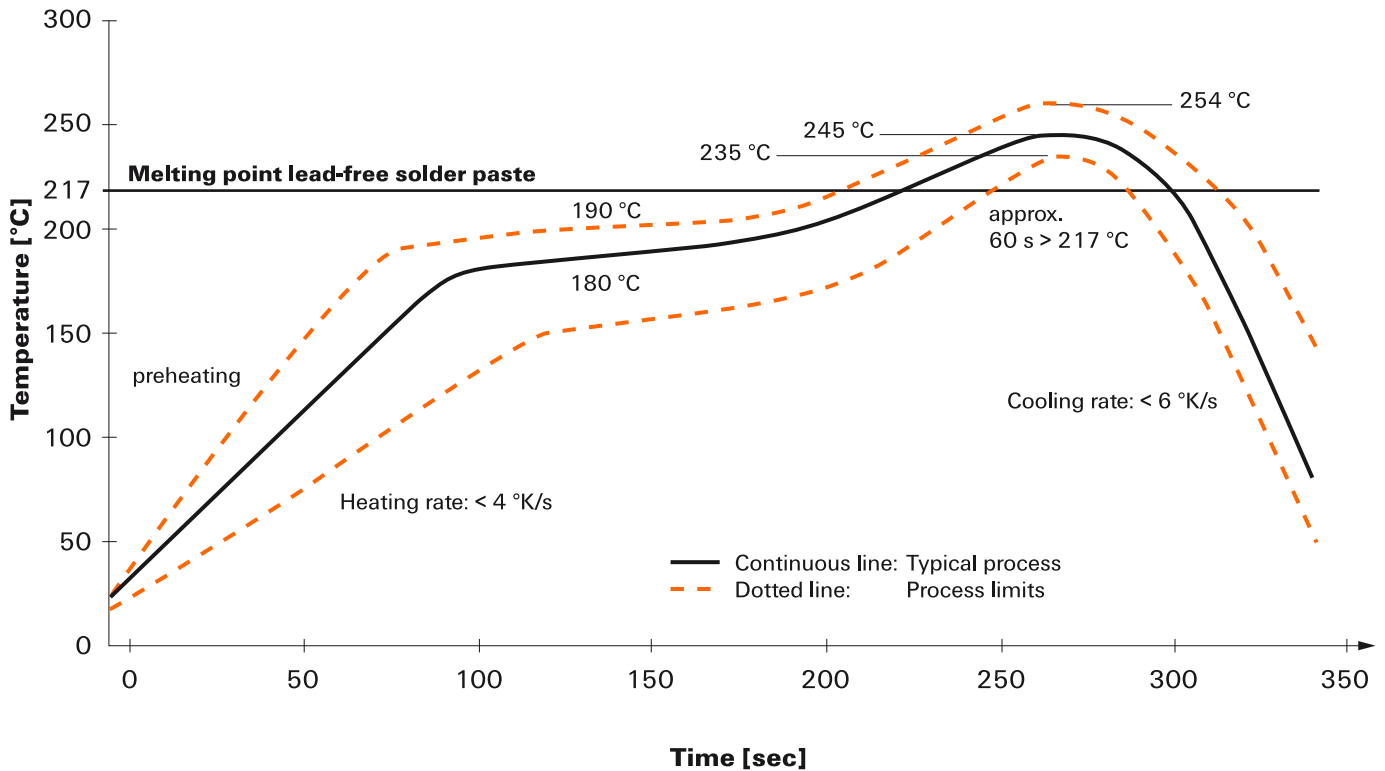

### Reflow soldering profile

The perfect soldering profile for SMT Surface Mount Technology is one the most exiting question in SMT production. But there are more than one correct answer: The diagram of temperature-on-time is related to processing features of solder paste and to maximum load of components.

We have to consider the following parameters:

- Time for pre heating
- Maximum temperature
- Time above melting point
- Time for cooling
- Maximum heating rate
- Maximum cooling rate

We recommend a typical solder profile with associated process limits. With preheating components and board are prepared smoothly for the solder phase. Heating rate is typically  $\leq +4\text{K/s}$ . In parallel the solder paste is ‚activated‘. The time above melting point of  $217\text{°C}$  the paste gets liquid and components and boards begin to connect. The maximum temperature of  $245\text{°C}$  to  $254\text{°C}$  should stay between 10 and 40 seconds. In the cooling phase at  $\geq -6\text{K/s}$  solder is cured. Board and components cool down while avoiding cold cracks.

## Recommended wave soldering profiles

**Weidmüller Interface GmbH & Co. KG**  
 Klingenbergstraße 16  
 D-32758 Detmold  
 Germany  
 Fon: +49 5231 14-0  
 Fax: +49 5231 14-292083  
 www.weidmueller.com

### Single Wave:

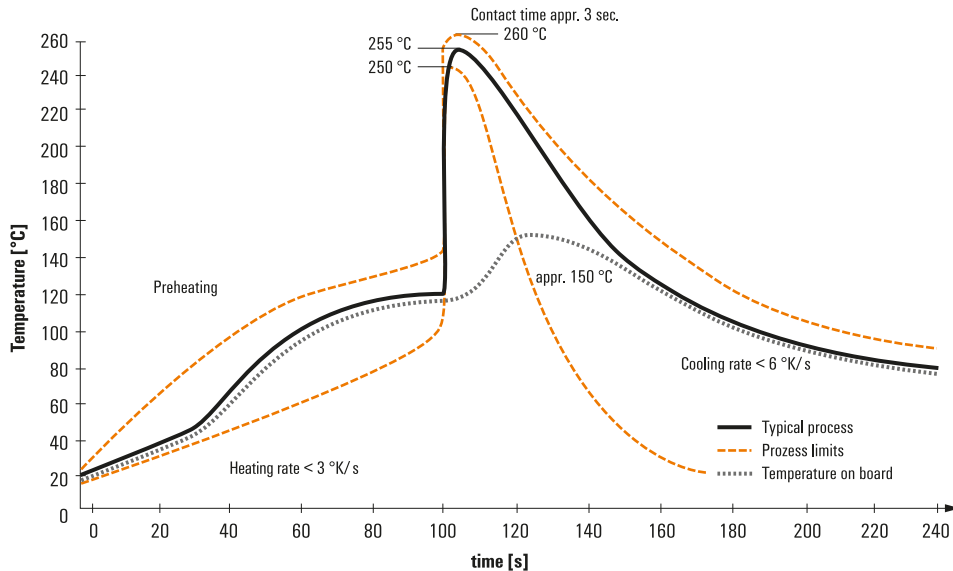

### Double Wave:

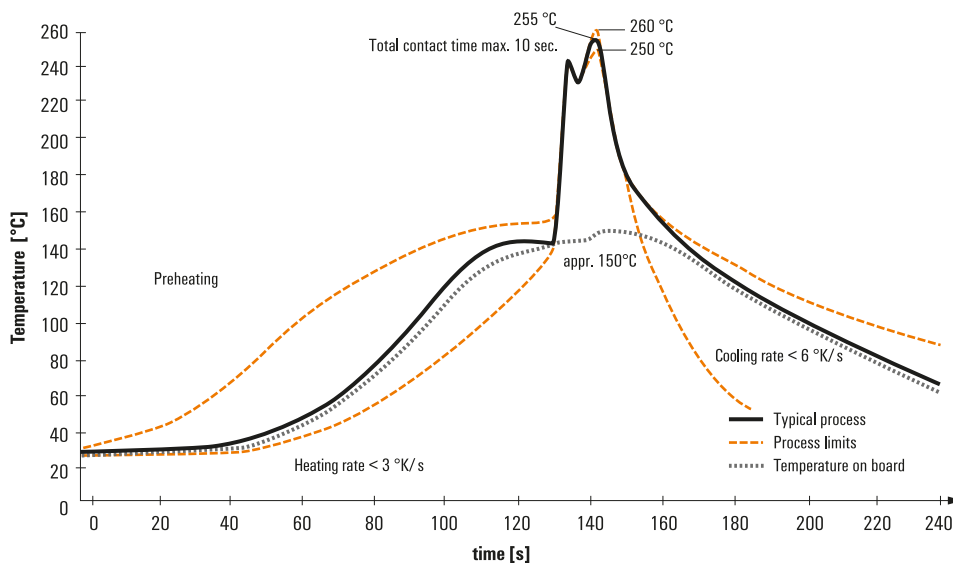

### Wave soldering profiles

Wired connection elements should be processed in accordance with the DIN EN 6 1760-1 standard. We have included two recommendations for practical wave soldering profiles, with which Weidmüller PCB terminals and connectors are qualified.

When choosing a suitable profile for your application, the following factors also need to be considered:

- PCB thickness
- Proportion of Cu in the layers
- Single/double-sided assembly
- Product range
- Heating and cooling rates

The single and double wave profiles each indicate the recommended operating range, including the maximum soldering temperature of 260°C. In practice, the maximum soldering temperature is quite often well below the above maximum profile.

We reserve the right to make technical changes.