

# DATA SHEET

## INDUCTOR

Power Inductors

BMRx Series

RoHS compliant & Halogen Free



## BMRx Series



BMRx series is designed for low profile type with low RDC and ultra large current. Its molded magnetic shielded type is suitable for high-density mounting and ultra low buzz noise. Soldering conditions can be easily confirmed when mounting onto the board. This series also provides customers with embossed carrier type packaging for automatic mounting machine.

### Features

- RoHS, Halogen Free and REACH Compliance
- High rated current
- Ultra low buzz noise

### Applications

- Laptops and PCs
- Switches and servers
- Base stations
- DC/DC converters

### Product Identification

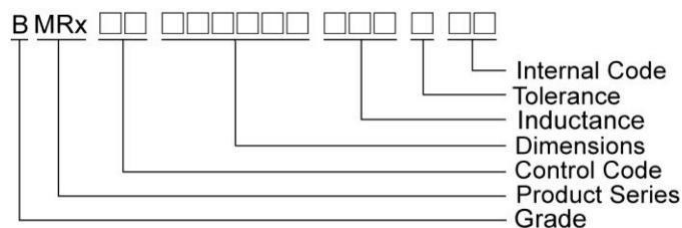

### Shape and Dimensions

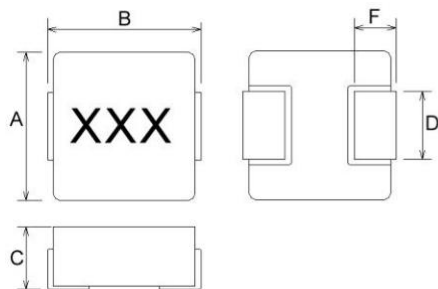

### Recommended Pattern

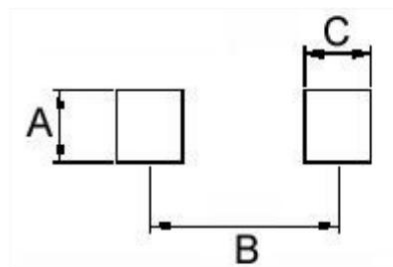

Dimensions in mm

TYPE	A	B Max	C Max	D	F
BMRA00040412	4.1±0.2	4.6±0.2	1.2	1.5±0.3	1.0±0.5
BMRA00040415	4.1±0.2	4.6±0.2	1.5	1.5±0.3	1.0±0.5
BMRA00040420	4.1±0.2	4.6±0.2	2.0	1.5±0.3	1.0±0.5
BMRB00050512	5.4±0.35	5.7±0.2	1.2	2.0±0.3	1.1±0.3
BMRx00050515	5.4±0.35	5.7±0.2	1.5	2.0±0.3	1.5±0.3
BMRB00050518	5.4±0.35	5.7±0.2	1.8	2.0±0.3	1.5±0.3
BMRB00050518-B	5.2±0.2	5.4±0.35	1.6±0.2	2.0±0.3	1.1±0.3
BMRA00050520	5.4±0.35	5.7±0.2	1.8±0.2	2.0±0.3	1.5±0.3
BMRA00050530	5.4±0.35	5.7±0.2	3.0	2.0±0.3	1.5±0.3

Dimensions in mm

TYPE	A	B	C
BMRA00040412	2.5	3.7	1.5
BMRA00040415	2.5	3.7	1.5
BMRA00040420	2.5	3.7	1.5
BMRB00050512	2.5	4.1	1.9
BMRx00050515	2.5	4.1	1.9
BMRB00050518	2.5	4.1	1.9
BMRA00050520	2.5	4.1	1.9
BMRA00050530	2.5	4.1	1.9

**Shape and Dimensions**

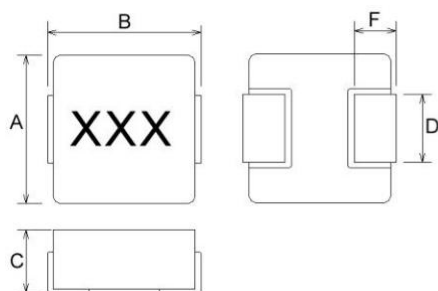

**Recommended Pattern**

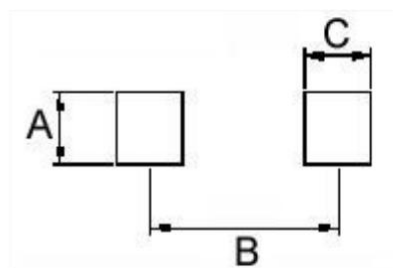

Dimensions in mm

TYPE	A	B Max	C Max	D	F
BMRB00060612	6.6±0.2	7.3	1.2	2.9	1.6±0.5
BMRx00060615	6.6±0.2	7.3	1.3±0.2	2.9	1.6±0.5
BMRB00060618	6.6±0.2	7.3	1.6±0.2	2.9	1.6±0.5
BMRB00060624	6.6±0.2	7.3	2.4	2.9	1.6±0.5
BMRx00060630	6.6±0.2	7.3	3.0	2.9	1.6±0.5
BMRB00060650	6.6±0.2	7.3	5.0	2.9	1.6±0.5
BMRG00101030	10.1±0.3	11.6	3.0	3.0	2.5±0.5
BMRF00101040	10.1±0.3	11.6	4.0	3.0	2.5±0.5
BMRF00131350	12.6±0.2	13.8	5.0	3.7	2.7±0.7
BMRG00131360	12.6±0.2	13.8	6.0	3.7	2.7±0.7

Dimensions in mm

TYPE	A	B	C
BMRB00060612	3.5	6.05	2.35
BMRx00060615	3.5	6.05	2.35
BMRB00060618	3.5	6.05	2.35
BMRB00060624	3.5	6.05	2.35
BMRx00060630	3.5	6.05	2.35
BMRB00060650	3.5	6.05	2.35
BMRG00101030	4.0	9.5	3.5
BMRF00101040	4.0	9.5	3.5
BMRF00131350	5.0	10.5	4.0
BMRG00131360	5.5	10.5	4.0

**Electrical Characteristics**

Part Number	Inductance (uH)	Tolerance (±%)	Test Frequency (kHz)	RDC (mΩ) Max	Isat (A)Typ.	Irms (A)Typ.
BMRA00040412R22MA1	0.22	20	100	12	11.5	8.5
BMRA00040412R33MA1	0.33	20	100	19	8.5	6.5
BMRA00040412R47MA1	0.47	20	100	25	7.0	5.0
BMRA00040412R68MA1	0.68	20	100	36	6.0	4.5
BMRA000404121R0MA1	1.0	20	100	47	5.2	4.2
BMRA000404121R5MA1	1.5	20	100	75	4.0	3.25
BMRA000404122R2MA1	2.2	20	100	83.5	3.5	2.75
BMRA000404123R3MA1	3.3	20	100	165	3.0	2.0
BMRA000404124R7MA1	4.7	20	100	195	2.8	1.8

**Note: When ordering, please specify tolerance code. Tolerance: M=±20%**

- Operating temperature range - 55°C ~ 125°C(Including self - temperature rise)
- Isat for Inductance drop 30% from its value without current
- Irms for a 40°C temperature rise from 25°C ambient with current
- Absolute maximum voltage 30VDC
- Measure Equipment :  
 L : WK 3260B or WK 6500P, 100kHz 0.5V  
 RDC : CHEN HWA 502 or CHEN HWA 46502B

**Test Instruments : WK3260B Impedance / Material Analyzer**

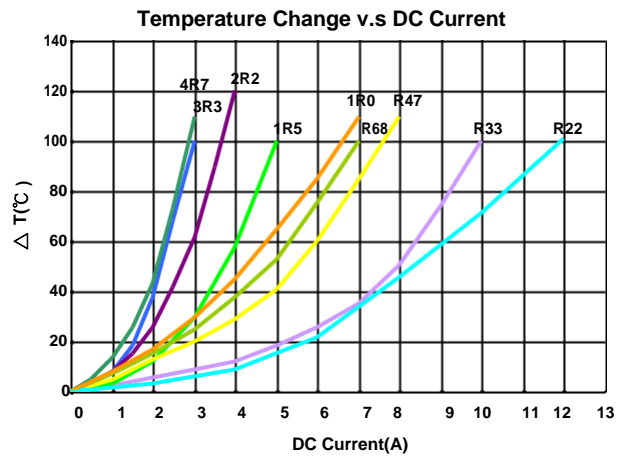
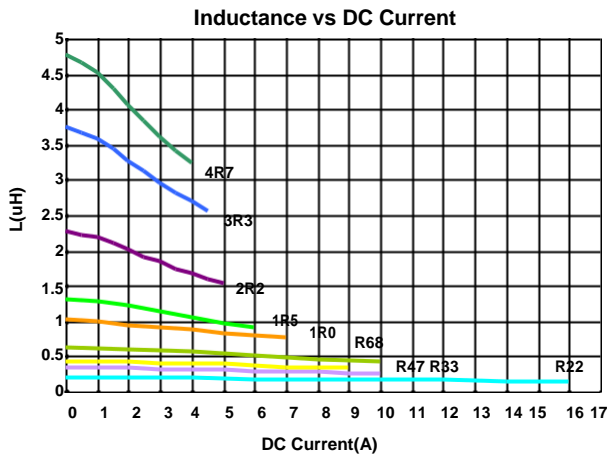

**Electrical Characteristics**

Part Number	Inductance (uH)	Tolerance (±%)	Test Frequency (kHz)	RDC (mΩ) Max	Isat (A)Typ.	Irms (A)Typ.
BMRA000404151R0MA1	1.0	20	100	42	7	4
BMRA000404151R5MA1	1.5	20	100	50	6	3.5
BMRA000404152R2MA1	2.2	20	100	79	5	3
BMRA000404153R3MA1	3.3	20	100	132	4.5	2.3
BMRA000404154R7MA1	4.7	20	100	146	4	2

**Note: When ordering, please specify tolerance code. Tolerance: M=±20%**

- Operating temperature range - 55°C ~ 125°C(Including self - temperature rise)
- Isat for Inductance drop 30% from its value without current
- I rms for a 40°C temperature rise from 25°C ambient with current
- Absolute maximum voltage 30VDC
- Measure Equipment :  
L : WK 3260B or WK 6500P, 100kHz 0.5V  
RDC : CHEN HWA 502 or CHEN HWA 46502B

**Test Instruments : WK3260B Impedance / Material Analyzer**

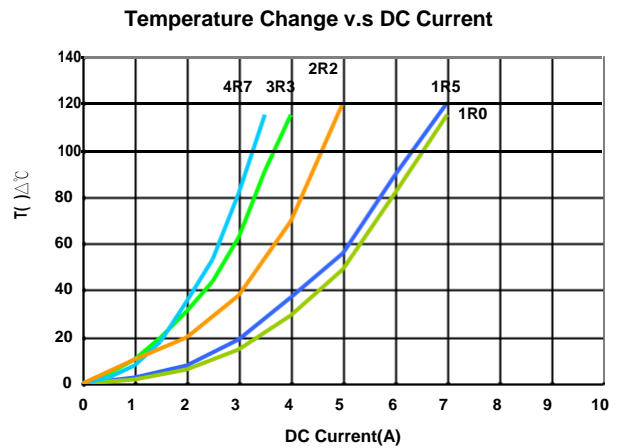
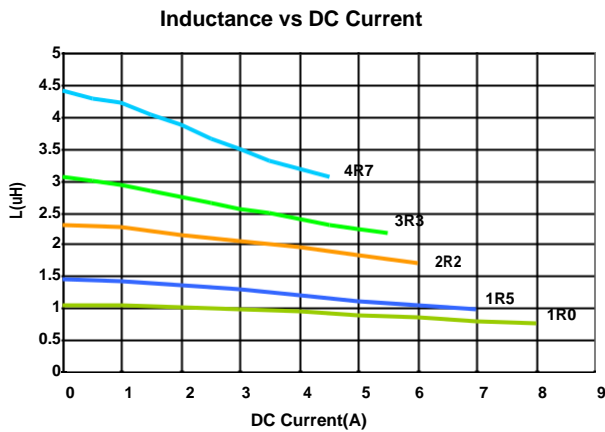

**Electrical Characteristics**

Part Number	Inductance (uH)	Tolerance (±%)	Test Frequency (kHz)	RDC (mΩ) Max	Isat (A)Typ.	Irms (A)Typ.
BMRA00040420R10MA1	0.10	20	100	4	25	12.0
BMRA00040420R22MA1	0.22	20	100	6.6	12.5	9.0
BMRA00040420R47MA1	0.47	20	100	14	9.5	7.0
BMRA00040420R56MA1	0.56	20	100	16	10.0	6.5
BMRA00040420R68MA1	0.68	20	100	21	8.0	5.2
BMRA00040420R10MA1	1.0	20	100	27	7.0	4.5
BMRA00040420R15MA1	1.5	20	100	46	6.0	4.0
BMRA00040420R22MA1	2.2	20	100	58	5.0	3.0
BMRA00040420R33MA1	3.3	20	100	87	4.0	2.5
BMRA00040420R47MA1	4.7	20	100	126	3.0	2.2
BMRA00040420R68MA1	6.8	20	100	135	2.5	2.0
BMRA00040420R82MA1	8.2	20	100	216	2.5	2.0
BMRA00040420R100MA1	10	20	100	258	2.0	1.6

**Note: When ordering, please specify tolerance code. Tolerance: M=±20%**

- Operating temperature range - 55°C ~ 125°C(Including self - temperature rise)
- Isat for Inductance drop 30% from its value without current
- Irms for a 40°C temperature rise from 25°C ambient with current
- Absolute maximum voltage 30VDC
- Measure Equipment :  
 L : WK 3260B or WK 6500P, 100KHz 0.5V  
 RDC : CHEN HWA 502 or CHEN HWA 46502B

**Test Instruments : WK3260B Impedance / Material Analyzer**

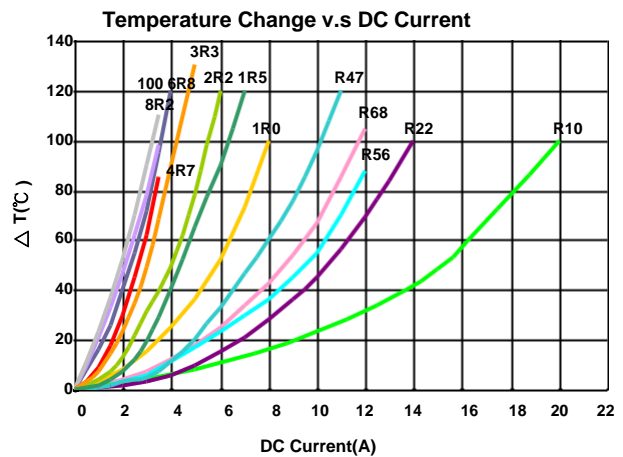
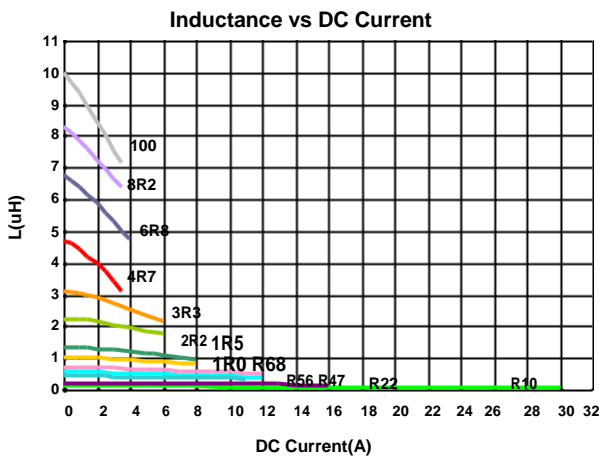

**Electrical Characteristics**

Part Number	Inductance (uH)	Tolerance (±%)	Test Frequency (kHz)	RDC (mΩ) Max	Isat (A)Typ.	Irms (A)Typ.
BMRB000505121R0MA1	1.0	20	100	30	6.0	5.0
BMRB000505122R2MA1	2.2	20	100	76	4.0	3.5
BMRB000505126R8MA1	6.8	20	100	250	2.3	2.0

**Note: When ordering, please specify tolerance code. Tolerance: M=±20%**

- Operating temperature range - 55°C ~ 125°C(Including self - temperature rise)
- Isat for Inductance drop 30% from its value without current
- Irms for a 40°C temperature rise from 25°C ambient with current
- Absolute maximum voltage 30VDC
- Measure Equipment :  
 L : WK 3260B or WK 6500P, 100kHz 0.5V  
 RDC : CHEN HWA 502 or CHEN HWA 46502B

**Test Instruments : WK3260B Impedance / Material Analyzer**

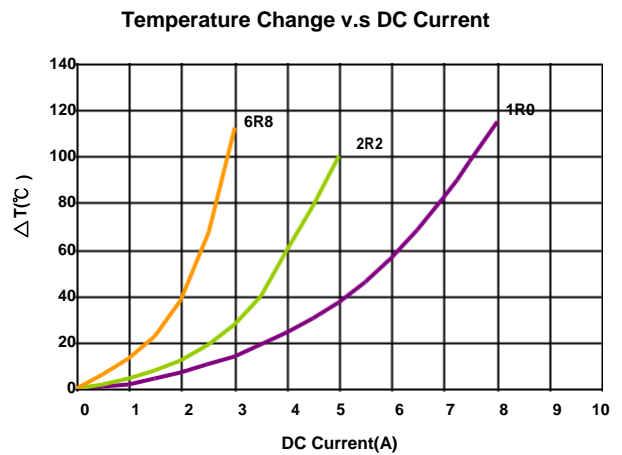
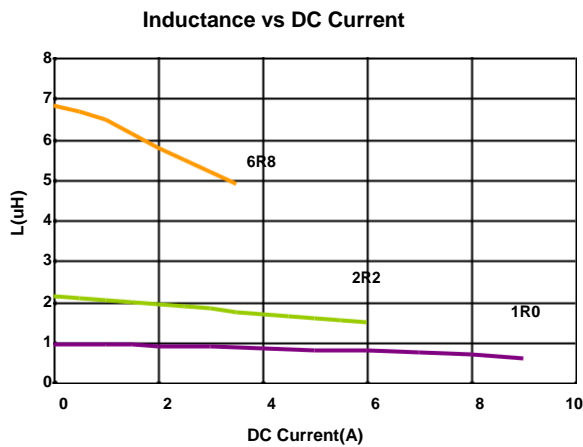

**Electrical Characteristics**

Part Number	Inductance (uH)	Tolerance (±%)	Test Frequency (kHz)	RDC (mΩ) Max	Isat (A)Typ.	Irms (A)Typ.
BMRA00050515R47MA1	0.47	20	100	16	12	8.0
BMRA00050515R68MA1	0.68	20	100	23	10	6.0
BMRA000505151R0MA1	1.0	20	100	33	8.0	5.0
BMRA000505151R5MA1	1.5	20	100	50	6.0	4.0
BMRA000505152R2MA1	2.2	20	100	68	6.0	3.3
BMRA000505153R3MA1	3.3	20	100	84	5.0	3.0
BMRA000505154R7MA1	4.7	20	100	135	4.0	2.5
BMRA000505155R6MA1	5.6	20	100	175	3.5	2.2
BMRA000505156R8MA1	6.8	20	100	192	3.0	2.0
BMRA00050515100MA1	10	20	100	195	2.0	1.5

**Note: When ordering, please specify tolerance code. Tolerance: M=±20%**

- Operating temperature range - 55°C ~ 125°C(Including self - temperature rise)
- Isat for Inductance drop 30% from its value without current
- Irms for a 40°C temperature rise from 25°C ambient with current
- Absolute maximum voltage 30VDC
- Measure Equipment :  
L : WK 3260B or WK 6500P, 100kHz 0.5V  
RDC : CHEN HWA 502 or CHEN HWA 46502B

**Test Instruments : WK3260B Impedance / Material Analyzer**

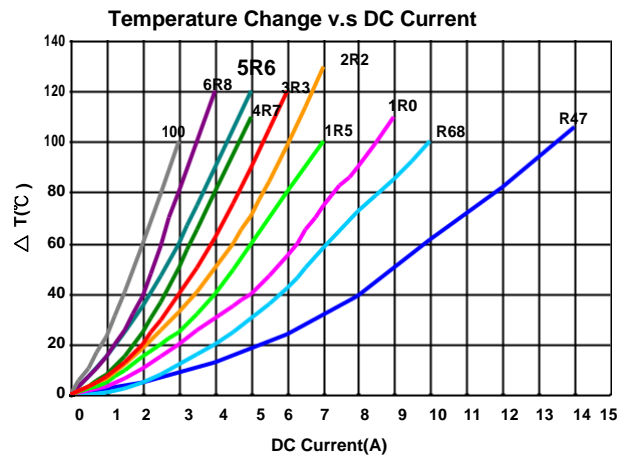
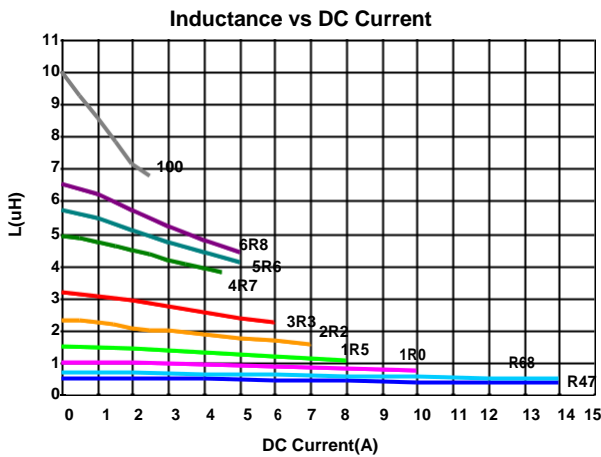



**Electrical Characteristics**

Part Number	Inductance (uH)	Tolerance (±%)	Test Frequency (kHz)	RDC (mΩ) Max	Isat (A)Typ.	Irms (A)Typ.
BMRB000505151R0MA1	1.0	20	100	23	9	6.5
BMRB000505152R2MA1	2.2	20	100	64	6	3.3
BMRB000505154R7MA1	4.7	20	100	106	4	3.0
BMRB00050515100MA1	10	20	100	170	3	2.0

**Note: When ordering, please specify tolerance code. Tolerance: M=±20%**

- Operating temperature range - 55°C ~ 125°C(Including self - temperature rise)
- Isat for Inductance drop 30% from its value without current
- Irms for a 40°C temperature rise from 25°C ambient with current
- Absolute maximum voltage 30VDC
- Measure Equipment :  
L : WK 3260B or WK 6500P, 100kHz 0.5V  
RDC : CHEN HWA 502 or CHEN HWA 46502B

**Test Instruments : WK3260B Impedance / Material Analyzer**

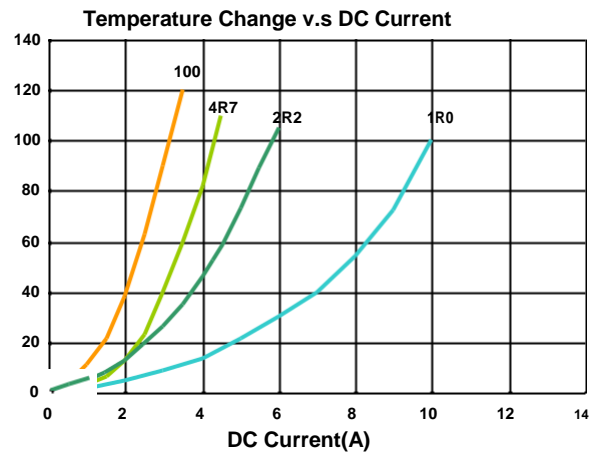
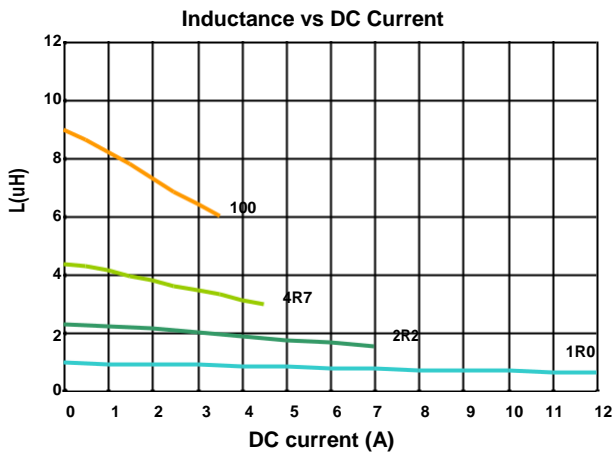

**Electrical Characteristics**

Part Number	Inductance (uH)	Tolerance (±%)	Test Frequency (kHz)	RDC(mΩ) Max(Typ)	Isat (A)Typ.	Irms (A)Typ.
BMRB00050518R47MB1	0.47	20	100	8.5(7.6)	15.5	10.5
BMRB00050518R68MB1	0.68	20	100	13.8(12)	13	9
BMRB000505181R0MB1	1.0	20	100	18(15)	10	8
BMRB000505181R5MB1	1.5	20	100	28(23)	9	6.2

**Note: When ordering, please specify tolerance code. Tolerance: M=±20%**

- Operating temperature range - 55°C ~ 125°C(Including self - temperature rise)
- Isat for Inductance drop 30% from its value without current
- Irms for a 40°C temperature rise from 25°C ambient with current
- Absolute maximum voltage 30VDC
- Measure Equipment :  
L : WK 3260B or WK 6500P, 100kHz 0.5V  
RDC : CHEN HWA 502 or CHEN HWA 46502B

**Test Instruments : WK3260B Impedance / Material Analyzer**

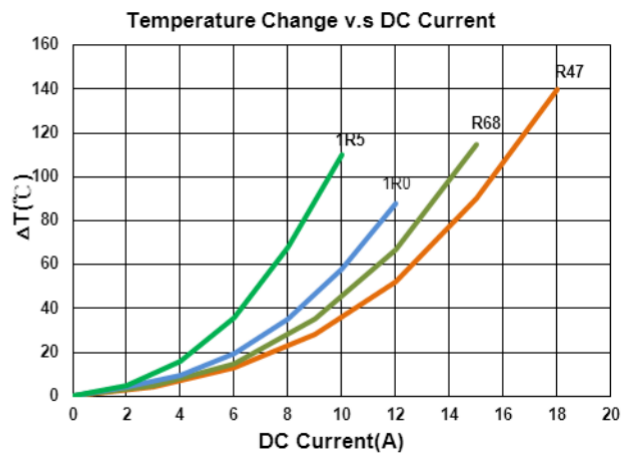
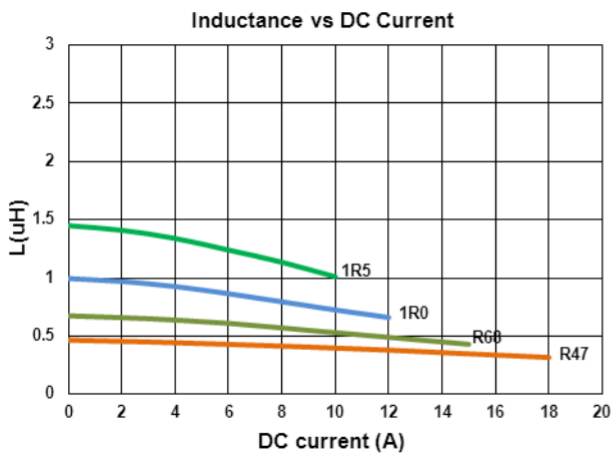

**Electrical Characteristics**

Part Number	Inductance (uH)	Tolerance (±%)	Test Frequency (kHz)	RDC (mΩ) Max	Isat (A)Typ.	Irms (A)Typ.
BMRB00050518R47MA1	0.47	20	100	9.0	15.5	10.5
BMRB000505181R0MA1	1.0	20	100	17	9.0	8.0
BMRB000505182R2MA1	2.2	20	100	35	6.5	5.0
BMRB000505183R3MA1	3.3	20	100	58	5.0	4.5
BMRB000505184R7MA1	4.7	20	100	85	4.0	3.5
BMRB000505186R8MA1	6.8	20	100	120	3.4	2.8
BMRB00050518100MA1	10	20	100	155	3.0	2.5

**Note: When ordering, please specify tolerance code. Tolerance: M=±20%**

- Operating temperature range - 55°C ~ 125°C(Including self - temperature rise)
- Isat for Inductance drop 30% from its value without current
- I rms for a 40°C temperature rise from 25°C ambient with current
- Absolute maximum voltage 30VDC
- Measure Equipment :  
L : WK 3260B or WK 6500P, 100kHz 0.5V  
RDC : CHEN HWA 502 or CHEN HWA 46502B

**Test Instruments : WK3260B Impedance / Material Analyzer**

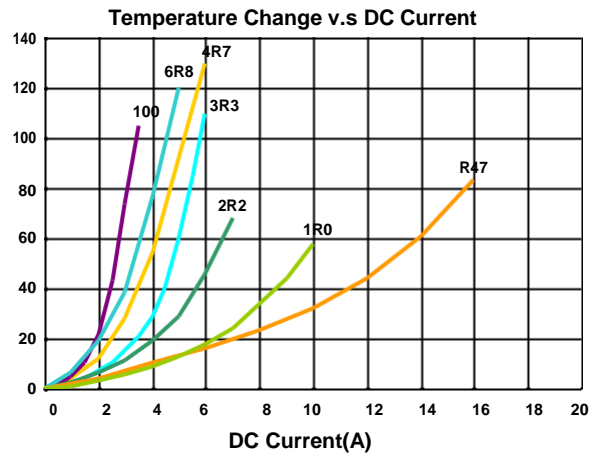
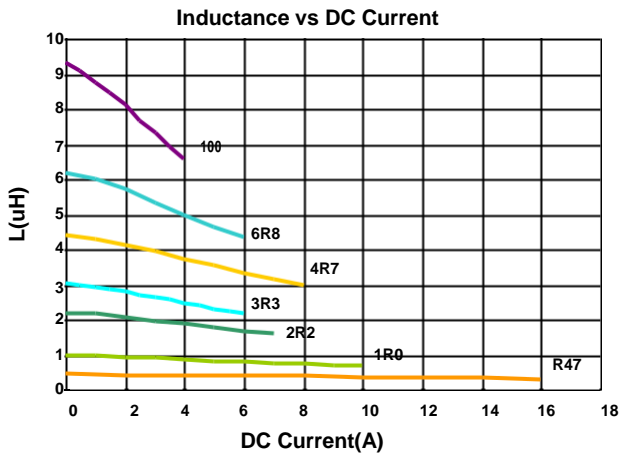

**Electrical Characteristics**

Part Number	Inductance (uH)	Tolerance (±%)	Test Frequency (kHz)	RDC (mΩ) Max	Isat (A)Typ.	Irms (A)Typ.
BMRA00050520R47MA1	0.47	20	100	9	15.5	10.5
BMRA000505201R0MA1	1.0	20	100	30	7.0	6.0
BMRA000505201R5MA1	1.5	20	100	35	6.5	5.5
BMRA000505202R2MA1	2.2	20	100	45	6.0	4.0
BMRA000505203R3MA1	3.3	20	100	60	5.5	3.5
BMRA000505204R7MA1	4.7	20	100	90	5.0	3.0
BMRA000505205R6MA1	5.6	20	100	120	4.5	2.8
BMRA000505206R8MA1	6.8	20	100	125	4.5	2.8
BMRA00050520100MA1	10	20	100	180	4.0	2.3

**Note: When ordering, please specify tolerance code. Tolerance: M=±20%**

- Operating temperature range - 55°C ~ 125°C(Including self - temperature rise)
- Isat for Inductance drop 30% from its value without current
- Irms for a 40°C temperature rise from 25°C ambient with current
- Absolute maximum voltage 30VDC
- Measure Equipment :  
L : WK 3260B or WK 6500P, 100kHz 0.5V  
RDC : CHEN HWA 502 or CHEN HWA 46502B

**Test Instruments : WK3260B Impedance / Material Analyzer**

**Inductance v.s DC Current**

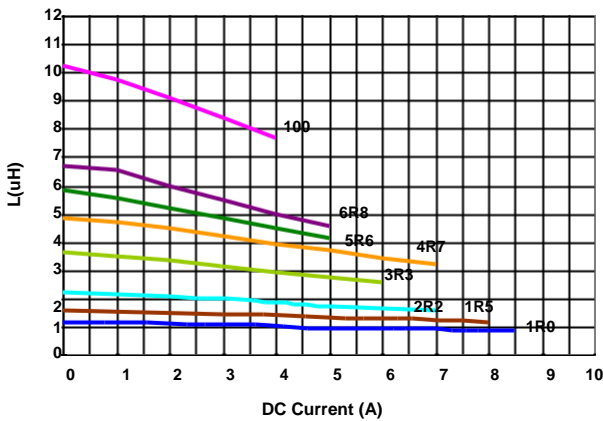

**Temperature Change v.s DC Current**

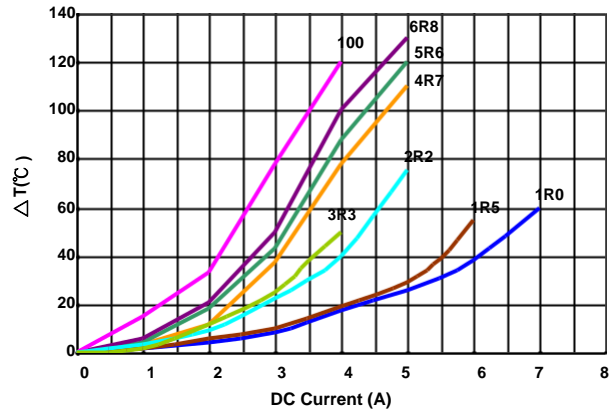

Electrical Characteristics

Part Number	Inductance (uH)	Tolerance (±%)	Test Frequency (kHz)	RDC (mΩ)Max	Isat (A)Typ.	Irms (A)Typ.
BMRA00050530R20MA1	0.20	20	100	3.9	14.5	17.0
BMRA00050530R47MA1	0.47	20	100	8	14	10.0
BMRA00050530R68MA1	0.68	20	100	12	14	8.0
BMRA000505301R0MA1	1.0	20	100	15	11	7.0
BMRA000505301R2MA1	1.2	20	100	15	11	6.5
BMRA000505301R5MA1	1.5	20	100	25	10	6.0
BMRA000505302R2MA1	2.2	20	100	35	8	5.0
BMRA000505303R3MA1	3.3	20	100	46	7	4.5
BMRA000505304R7MA1	4.7	20	100	60	6	4.0
BMRA000505306R8MA1	6.8	20	100	110	5	3.0
BMRA00050530100MA1	10	20	100	126	4.5	2.5

Note: When ordering, please specify tolerance code. Tolerance: M=±20%

- Operating temperature range - 55°C ~ 125°C(Including self - temperature rise)
- Isat for Inductance drop 30% from its value without current
- I rms for a 40°C temperature rise from 25°C ambient with current
- Absolute maximum voltage 30VDC
- Measure Equipment :  
L : WK 3260B or WK 6500P, 100kHz 0.5V  
RDC : CHEN HWA 502 or CHEN HWA 46502B

Test Instruments : WK3260B Impedance / Material Analyzer

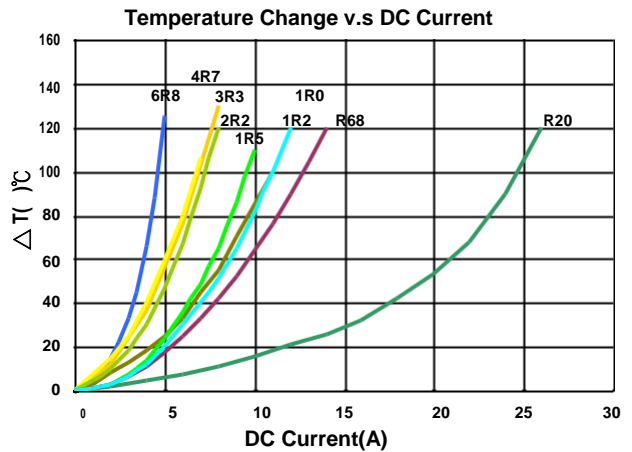
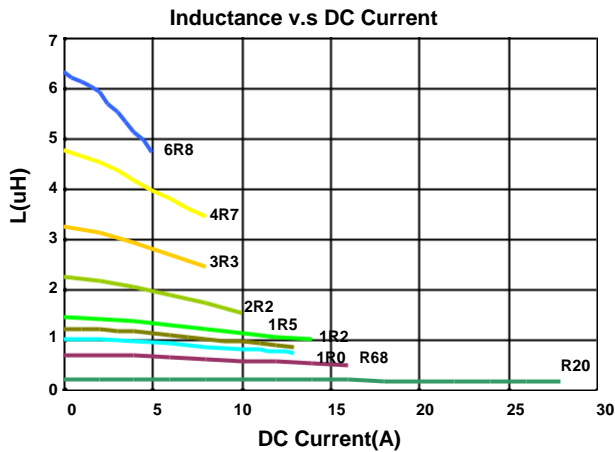

**Electrical Characteristics**

Part Number	Inductance (uH)	Tolerance (±%)	Test Frequency (kHz)	RDC (mΩ) Max	Isat (A)Typ.	Irms (A)Typ.
BMRB000606124R7MA1	4.7	20	100	122	3.5	2.5
BMRB000606126R8MA1	6.8	20	100	210	2.8	2.2

**Note: When ordering, please specify tolerance code. Tolerance: M=±20%**

- Operating temperature range - 55°C ~ 125°C(Including self - temperature rise)
- Isat for Inductance drop 30% from its value without current
- I rms for a 40°C temperature rise from 25°C ambient with current
- Absolute maximum voltage 30VDC
- Measure Equipment :  
 L : WK 3260B or WK 6500P, 100kHz 0.5V  
 RDC : CHEN HWA 502 or CHEN HWA 46502B

**Test Instruments :** WK3260B Impedance / Material Analyzer

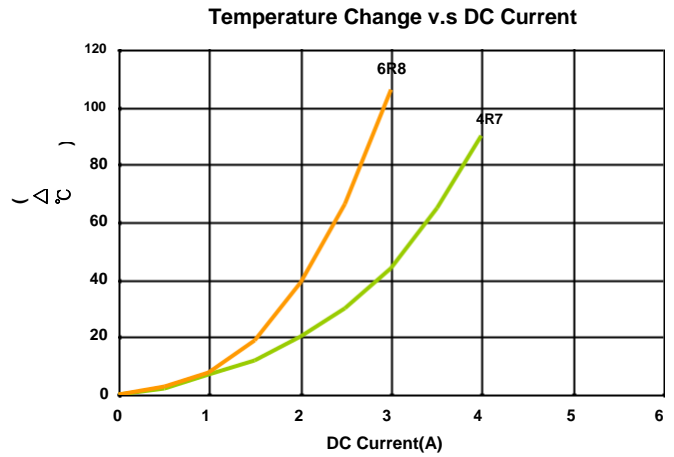
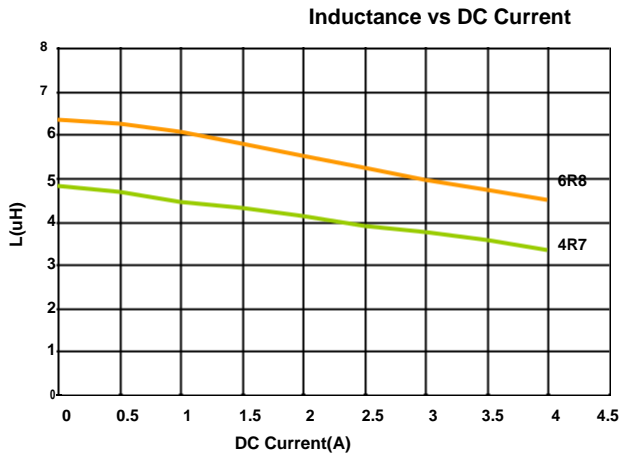

**Electrical Characteristics**

Part Number	Inductance (uH)	Tolerance (±%)	Test Frequency (kHz)	RDC (mΩ)Max	Isat (A)Typ.	Irms (A)Typ.
BMRA000606152R2MA1	2.2	20	100	54	6.0	3.5
BMRA000606153R3MA1	3.3	20	100	63	5.5	3.3
BMRA000606154R7MA1	4.7	20	100	105	4.5	3.2
BMRA000606156R8MA1	6.8	20	100	140	4.0	2.5

**Note: When ordering, please specify tolerance code. Tolerance: M=±20%**

- Operating temperature range - 55°C ~ 125°C(Including self - temperature rise)
- Isat for Inductance drop 30% from its value without current
- I rms for a 40°C temperature rise from 25°C ambient with current
- Absolute maximum voltage 30VDC
- Measure Equipment :  
L : WK 3260B or WK 6500P, 100kHz 0.5V  
RDC : CHEN HWA 502 or CHEN HWA 46502B

**Test Instruments :** WK3260B Impedance / Material Analyzer

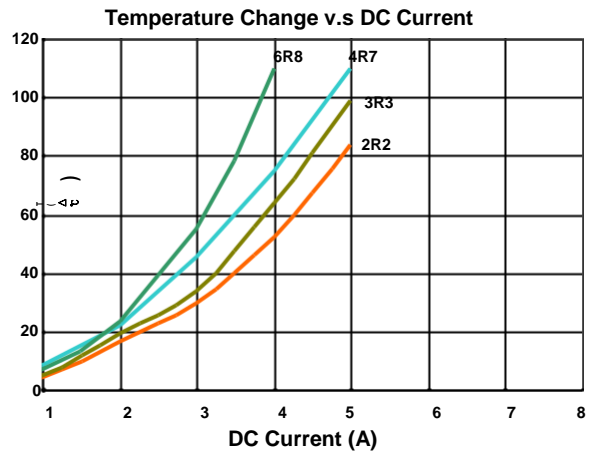
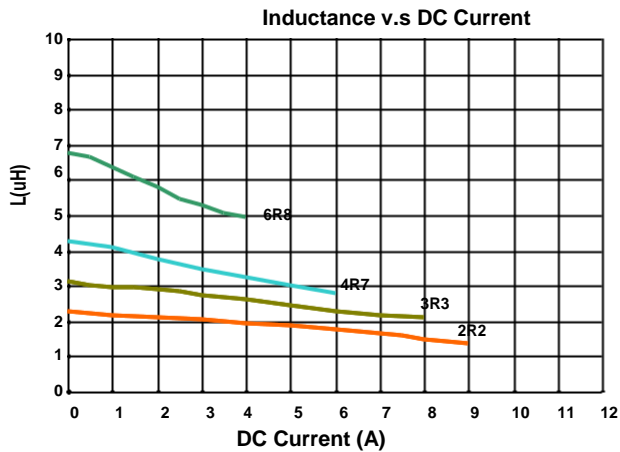

**Electrical Characteristics**

Part Number	Inductance (uH)	Tolerance (±%)	Test Frequency (kHz)	RDC (mΩ)Max	Isat (A)Typ.	Irms (A)Typ.
BMRB000606151R0MA1	1.0	20	100	21	9.0	5.5
BMRB000606153R3MA1	3.3	20	100	63	5.5	3.3
BMRB00060615100MA1	10	20	100	175	3.0	2.0

**Note: When ordering, please specify tolerance code. Tolerance: M=±20%**

- Operating temperature range - 55°C ~ 125°C(Including self - temperature rise)
- Isat for Inductance drop 30% from its value without current
- I rms for a 40°C temperature rise from 25°C ambient with current
- Absolute maximum voltage 30VDC
- Measure Equipment :  
L : WK 3260B or WK 6500P, 100kHz 0.5V  
RDC : CHEN HWA 502 or CHEN HWA 46502B

**Test Instruments : WK3260B Impedance / Material Analyzer**

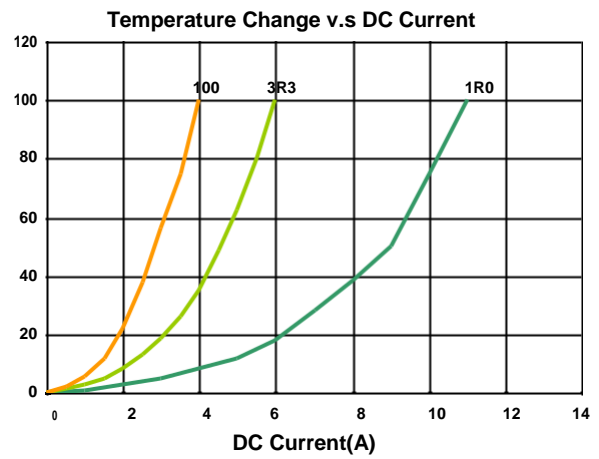
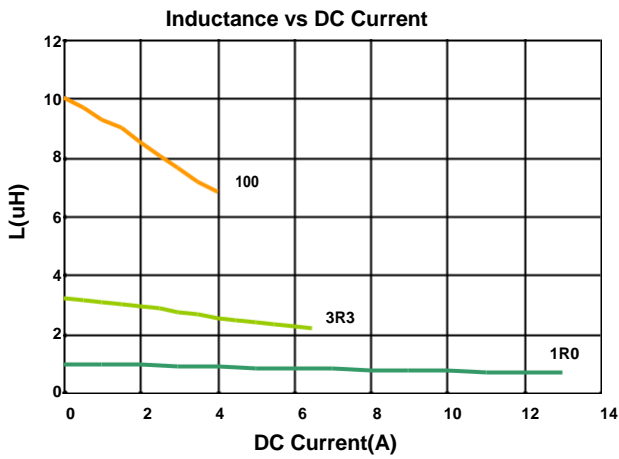



Electrical Characteristics

Part Number	Inductance (uH)	Tolerance (±%)	Test Frequency (kHz)	RDC (mΩ)Max	Isat (A)Typ.	Irms (A)Typ.
BMRB00060618R22MA1	0.22	20	100	5.2	29	14
BMRB00060618R33MA1	0.33	20	100	6.8	22	12
BMRB00060618R47MA1	0.47	20	100	8.4	18	11
BMRB00060618R68MA1	0.68	20	100	12.7	17	9
BMRB000606181R0MA1	1.0	20	100	17	14	7
BMRB000606181R5MA1	1.5	20	100	26	12	6.5
BMRB000606182R2MA1	2.2	20	100	35	10	6.0
BMRB000606184R7MA1	4.7	20	100	70	5	3.5
BMRB000606186R8MA1	6.8	20	100	110	3.5	2.8
BMRB00060618100MA1	10	20	100	155	2.5	2.3

Note: When ordering, please specify tolerance code. Tolerance: M=±20%

- Operating temperature range - 55°C ~ 125°C(Including self - temperature rise)
- Isat for Inductance drop 30% from its value without current
- Irms for a 40°C temperature rise from 25°C ambient with current
- Absolute maximum voltage 30VDC
- Measure Equipment :  
L : WK 3260B or WK 6500P, 100kHz 0.5V  
RDC : CHEN HWA 502 or CHEN HWA 46502B

Test Instruments : WK3260B Impedance / Material Analyzer

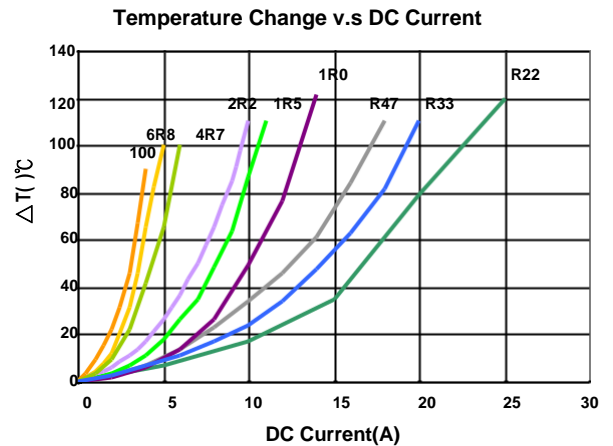
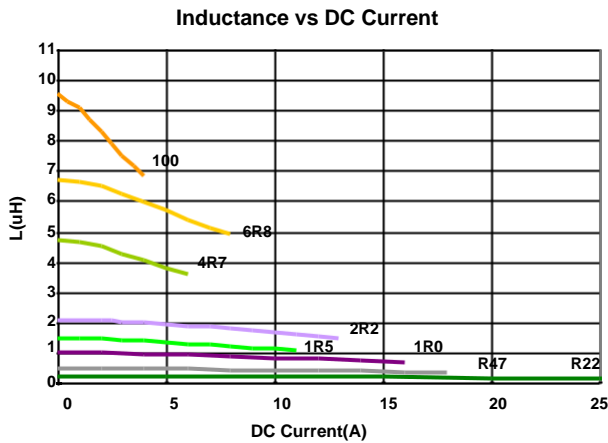

partment before ordering.

**Electrical Characteristics**

Part Number	Inductance (uH)	Tolerance (±%)	Test Frequency (kHz)	RDC (mΩ)Max	Isat (A)Typ.	Irms (A)Typ.
BMRB00060624R22MA1	0.22	20	100	3.2	34	21
BMRB00060624R33MA1	0.33	20	100	4.1	24.5	18
BMRB00060624R47MA1	0.47	20	100	5.1	22	15
BMRB000606241R0MA1	1.0	20	100	13.5	16	9
BMRB000606241R5MA1	1.5	20	100	20	15	9
BMRB000606242R2MA1	2.2	20	100	28	11	7
BMRB000606243R3MA1	3.3	20	100	39	10	5.5
BMRB000606244R7MA1	4.7	20	100	50	10	5.0
BMRB000606246R8MA1	6.8	20	100	70	6.0	4.0
BMRB00060624100MA1	10	20	100	101	4.0	3.1
BMRB00060624150MA1	15	20	100	160	3.3	2.5

**Note: When ordering, please specify tolerance code. Tolerance: M=±20%**

- Operating temperature range - 55°C ~ 125°C(Including self - temperature rise)
- Isat for Inductance drop 30% from its value without current
- Irms for a 40°C temperature rise from 25°C ambient with current
- Absolute maximum voltage 30VDC
- Measure Equipment :  
L : WK 3260B or WK 6500P, 100kHz 0.5V  
RDC : CHEN HWA 502 or CHEN HWA 46502B

**Test Instruments : WK3260B Impedance / Material Analyzer**

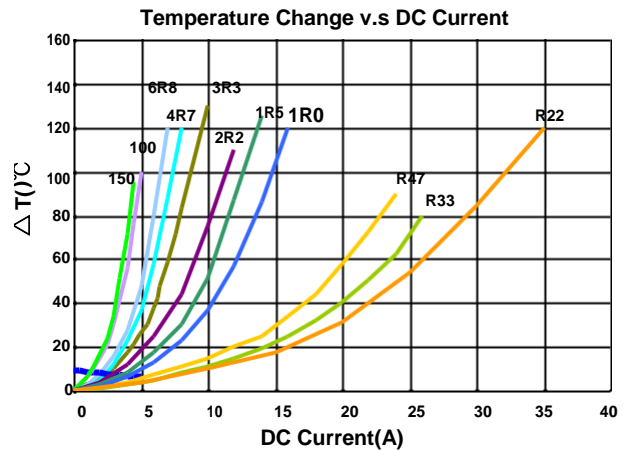
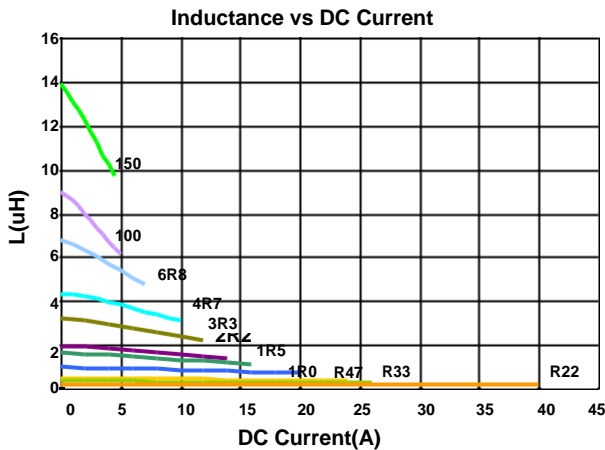

Electrical Characteristics

Part Number	Inductance (uH)	Tolerance (±%)	Test Frequency (kHz)	RDC (mΩ) Max	Isat (A)Typ.	Irms (A)Typ.
BMRA00060630R10MA1	0.10	20	100	1.5	45	37
BMRA00060630R22MA1	0.22	20	100	2.8	40	23
BMRA00060630R33MA1	0.33	20	100	4.2	33	20
BMRA00060630R47MA1	0.47	20	100	5.5	27	16.5
BMRA00060630R56MA1	0.56	20	100	5.5	27	16.5
BMRA00060630R68MA1	0.68	20	100	6.3	24	15
BMRA00060630R82MA1	0.82	20	100	8.0	23	13
BMRA00060630R10MA1	1.0	20	100	10	22	12
BMRA00060630R15MA1	1.5	20	100	15	18	9.5
BMRA00060630R18MA1	1.8	20	100	15	14	9.5
BMRA00060630R22MA1	2.2	20	100	20	14	8.5
BMRA00060630R33MA1	3.3	20	100	35	12	6.0
BMRA00060630R47MA1	4.7	20	100	40	9	5.5
BMRA00060630R56MA1	5.6	20	100	40	8	5.5
BMRA00060630R68MA1	6.8	20	100	60	8	4.5
BMRF00060630R82MA1	8.2	20	100	60	6	4.5
BMRF00060630R100MA1	10	20	100	68	5.5	4.0
BMRA00060630R150MA1	15	20	100	122	5.0	3.0
BMRA00060630R220MA1	22	20	100	145	3.2	3.0
BMRA00060630R330MA1	33	20	100	270	3.0	2.0

Note: When ordering, please specify tolerance code. Tolerance: M=±20%

- Operating temperature range - 55°C ~ 125°C(Including self - temperature rise)
- Isat for Inductance drop 30% from its value without current
- Irms for a 40°C temperature rise from 25°C ambient with current
- Absolute maximum voltage 30VDC
- Measure Equipment :  
L : WK 3260B or WK 6500P, 100kHz 0.5V  
RDC : CHEN HWA 502 or CHEN HWA 46502B

Test Instruments : WK3260B Impedance / Material Analyzer

Inductance v.s DC Current

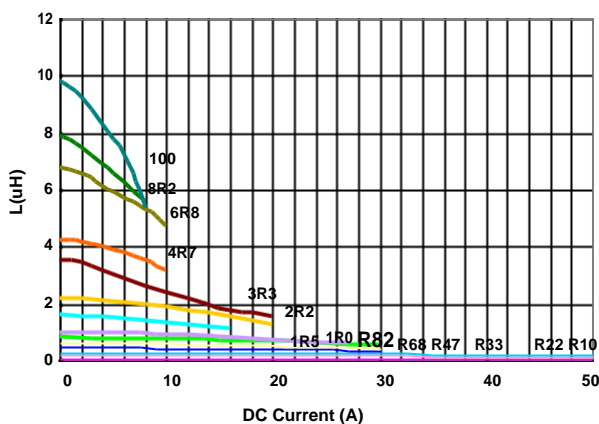

Temperature Change v.s DC Current

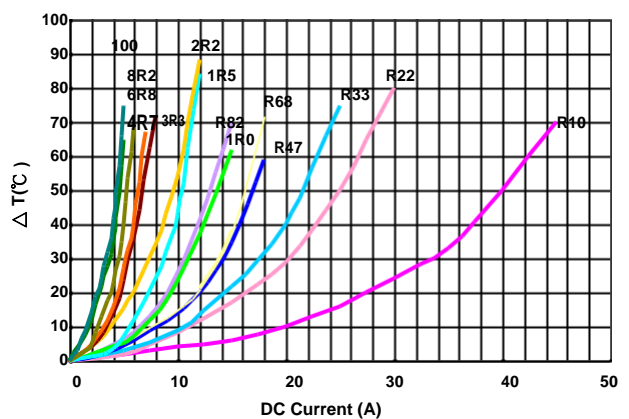

**Electrical Characteristics**

Part Number	Inductance (uH)	Tolerance (±%)	Test Frequency (kHz)	RDC (mΩ)Max	Isat (A)Typ.	Irms (A)Typ.
BMRB00060630R10MA1	0.10	20	100	1.7	60	32.5
BMRB00060630R15MA1	0.15	20	100	2.5	40	30
BMRB00060630R22MA1	0.22	20	100	3.0	34	23
BMRB00060630R33MA1	0.33	20	100	3.5	25	21
BMRB00060630R36MA1	0.36	20	100	3.9	24	20
BMRB00060630R47MA1	0.47	20	100	4.1	20	18
BMRB00060630R56MA1	0.56	20	100	4.5	18	16.5
BMRB00060630R68MA1	0.68	20	100	5.3	17	16
BMRB00060630R82MA1	0.82	20	100	6.0	16	14
BMRB000606301R0MA1	1.0	20	100	7.4	15	12
BMRB000606301R2MA1	1.2	20	100	10	14	10
BMRB000606301R5MA1	1.5	20	100	12.1	14	10
BMRB000606302R2MA1	2.2	20	100	15	10	8
BMRB000606303R3MA1	3.3	20	100	22	9.5	6.5
BMRB000606304R7MA1	4.7	20	100	33	6.5	5.5
BMRB000606305R6MA1	5.6	20	100	42	6	5.5
BMRB000606306R8MA1	6.8	20	100	50	6	4.5
BMRB000606308R2MA1	8.2	20	100	60	6	4.5
BMRB00060630100MA1	10	20	100	68	5.5	4

**Note: When ordering, please specify tolerance code. Tolerance: M=±20%**

- Operating temperature range - 55°C ~ 125°C(Including self - temperature rise)
- Isat for Inductance drop 30% from its value without current
- Irms for a 40°C temperature rise from 25°C ambient with current
- Absolute maximum voltage 30VDC
- Measure Equipment :  
L : WK 3260B or WK 6500P, 100kHz 0.5V  
RDC : CHEN HWA 502 or CHEN HWA 46502B

**Test Instruments : WK3260B Impedance / Material Analyzer**

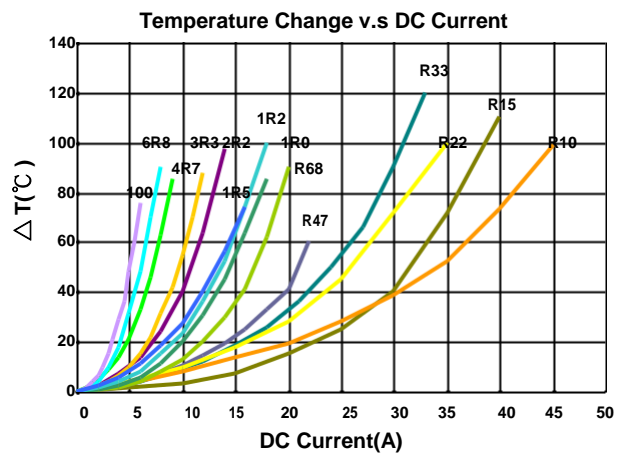
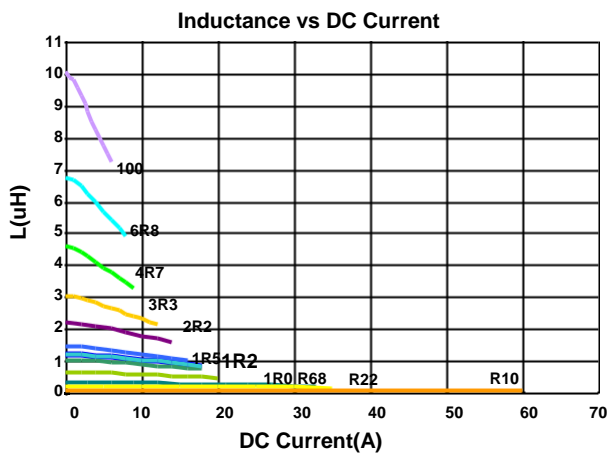

**Electrical Characteristics**

Part Number	Inductance (uH)	Tolerance (±%)	Test Frequency (kHz)	RDC (mΩ) Max	Isat (A)Typ.	Irms (A)Typ.
BMRB00060650R56MA1	0.56	20	100	3.3	20	20
BMRB000606501R0MA1	1.0	20	100	6.5	15	13
BMRB000606502R2MA1	2.2	20	100	12.5	12	8
BMRB000606503R3MA1	3.3	20	100	20.9	9	7
BMRB000606504R7MA1	4.7	20	100	25.0	7	6.5

**Note: When ordering, please specify tolerance code. Tolerance: M=±20%**

- Operating temperature range - 55°C ~ 125°C(Including self - temperature rise)
- Isat for Inductance drop 30% from its value without current
- Irms for a 40°C temperature rise from 25°C ambient with current
- Absolute maximum voltage 30VDC
- Measure Equipment :  
L : WK 3260B or WK 6500P, 100kHz 0.5V  
RDC : CHEN HWA 502 or CHEN HWA 46502B

**Test Instruments : WK3260B Impedance / Material Analyzer**

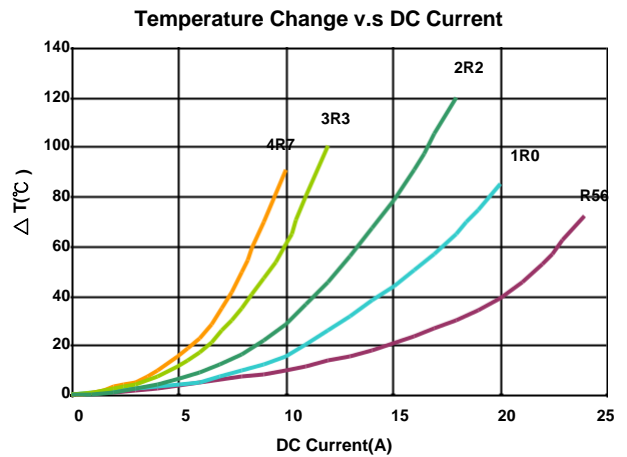
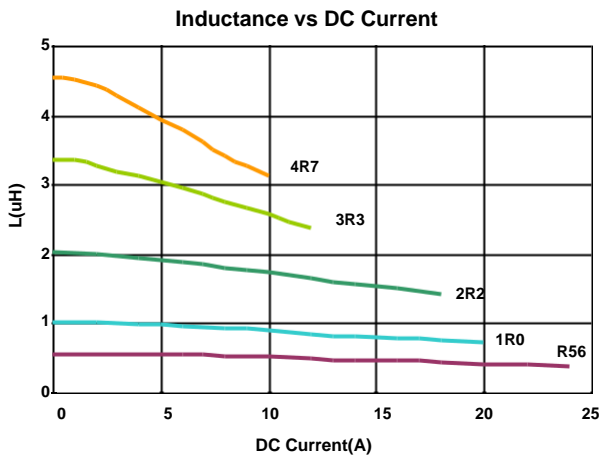

**Electrical Characteristics**

Part Number	Inductance (uH)	Tolerance (±%)	Test Frequency (kHz)	RDC (mΩ) Max	Isat (A)Typ.	Irms (A)Typ.
BMRG00101030R33MD1	0.33	20	100	1.6	32	23
BMRG001010301R0MD1	1.0	20	100	6.0	21	15
BMRG001010303R3MA1	3.3	20	100	16.0	14	9

**Note: When ordering, please specify tolerance code. Tolerance: M=±20%**

- Operating temperature range - 55°C ~ 125°C(Including self - temperature rise)
- Isat for Inductance drop 30% from its value without current
- Irms for a 40°C temperature rise from 25°C ambient with current
- Absolute maximum voltage 30VDC
- Measure Equipment :  
 L : WK 3260B or WK 6500P, 100kHz 0.5V  
 RDC : CHEN HWA 502 or CHEN HWA 46502B

**Test Instruments :** WK3260B Impedance / Material Analyzer

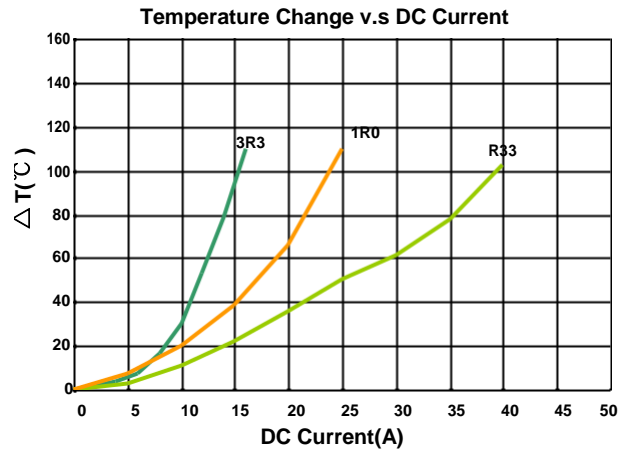
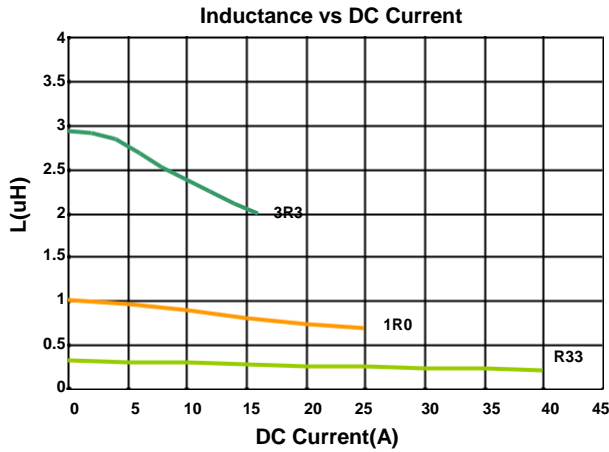

**Electrical Characteristics**

Part Number	Inductance (uH)	Tolerance (±%)	Test Frequency (kHz)	RDC (mΩ) Max	Isat (A)Typ.	Irms (A)Typ.
BMRF00101040R22MD1	0.22	20	100	0.6	45	35
BMRF00101040R36MD1	0.36	20	100	1.2	42	34
BMRF00101040R45MD1	0.45	20	100	1.2	38	33
BMRF00101040R47MD1	0.47	20	100	1.2	38	33
BMRF00101040R56MD1	0.56	20	100	1.55	32	27
BMRF00101040R68MD1	0.68	20	100	1.55	30	27
BMRF00101040R90MD1	0.9	20	100	3.0	20	22
BMRF001010401R0MD1	1.0	20	100	3.1	26	20
BMRF001010401R5MD1	1.5	20	100	4.2	22	16
BMRF001010401R8MD1	1.8	20	100	5	16	15.3
BMRF001010402R2MD1	2.2	20	100	7	16	14
BMRF001010403R3MA1	3.3	20	100	13.2	12	11
BMRF001010404R7MA1	4.7	20	100	16.5	12	9
BMRF001010406R8MA1	6.8	20	100	25	10	6
BMRF001010408R2MA1	8.2	20	100	30	9	6
BMRF00101040100MA1	10	20	100	30	7	6.5
BMRF00101040150MA1	15	20	100	45	6	6.25
BMRF00101040220MA1	22	20	100	64	4.5	4.5

**Note: When ordering, please specify tolerance code. Tolerance: M=±20%**

- Operating temperature range - 55°C ~ 125°C(Including self - temperature rise)
- Isat for Inductance drop 30% from its value without current
- Irms for a 40°C temperature rise from 25°C ambient with current
- Absolute maximum voltage 30VDC
- Measure Equipment :  
 L : WK 3260B or WK 6500P, 100kHz 0.5V  
 RDC : CHEN HWA 502 or CHEN HWA 46502B

**Test Instruments : WK3260B Impedance / Material Analyzer**

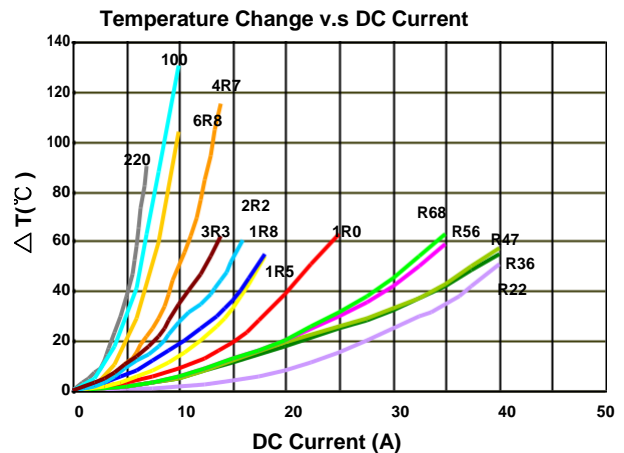
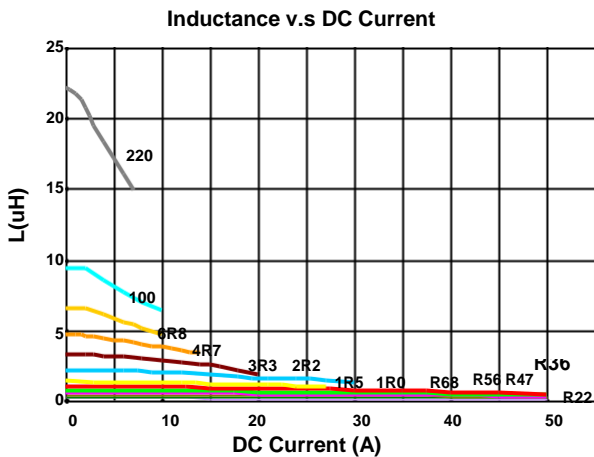

**Electrical Characteristics**

Part Number	Inductance (uH)	Tolerance (±%)	Test Frequency (kHz)	RDC (mΩ) Max	Isat (A)Typ.	Irms (A)Typ.
BMRF00131350R47MD1	0.47	20	100	1.2	46	37
BMRF001313501R0MD1	1.0	20	100	2.5	37	29
BMRF001313501R5MD1	1.5	20	100	3.0	28	28
BMRF001313504R7MD1	4.7	20	100	11.5	16	11
BMRF001313506R8MA1	6.8	20	100	22	14	9
BMRF00131350100MA1	10	20	100	35	13	7

**Note: When ordering, please specify tolerance code. Tolerance: M=±20%**

- Operating temperature range - 55°C ~ 125°C(Including self - temperature rise)
- Isat for Inductance drop 30% from its value without current
- I rms for a 40°C temperature rise from 25°C ambient with current
- Absolute maximum voltage 30VDC
- Measure Equipment :  
 L : WK 3260B or WK 6500P, 100kHz 0.5V  
 RDC : CHEN HWA 502 or CHEN HWA 46502B

**Test Instruments :** WK3260B Impedance / Material Analyzer

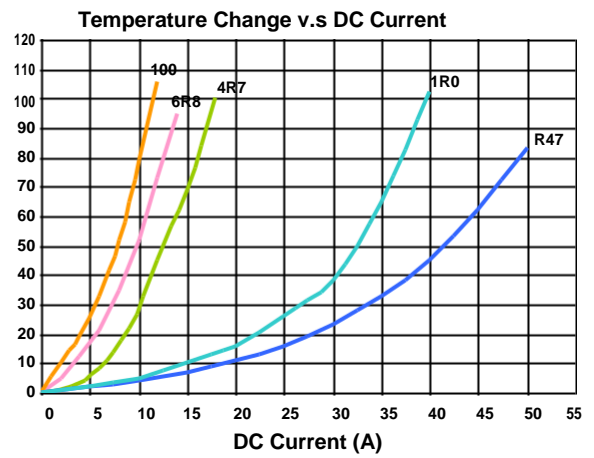
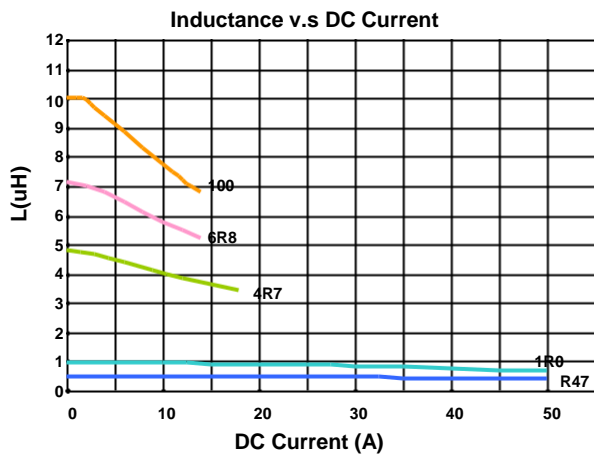



**Electrical Characteristics**

Part Number	Inductance (uH)	Tolerance (±%)	Test Frequency (kHz)	RDC (mΩ) Max	Isat (A)Typ.	Irms (A)Typ.
BMRG00131360100MA1	10	20	100	20.7	12.5	10
BMRG00131360150MA1	15	20	100	29.0	9.0	6.0
BMRG00131360220MA1	22	20	100	39.5	7.5	5.0
BMRG00131360330MA1	33	20	100	75	6.0	4.0

**Note: When ordering, please specify tolerance code. Tolerance: M=±20%**

- Operating temperature range - 55°C ~ 125°C(Including self - temperature rise)
- Isat for Inductance drop 30% from its value without current
- Irms for a 40°C temperature rise from 25°C ambient with current
- Absolute maximum voltage 30VDC
- Measure Equipment :  
 L : WK 3260B or WK 6500P, 100kHz 0.5V  
 RDC : CHEN HWA 502 or CHEN HWA 46502B

**Test Instruments : WK3260B Impedance / Material Analyzer**

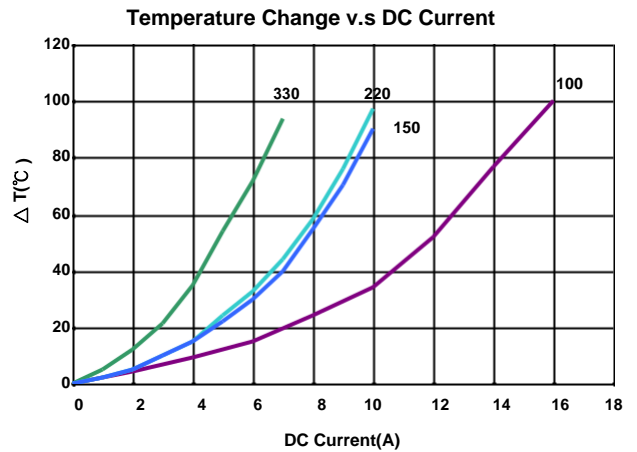
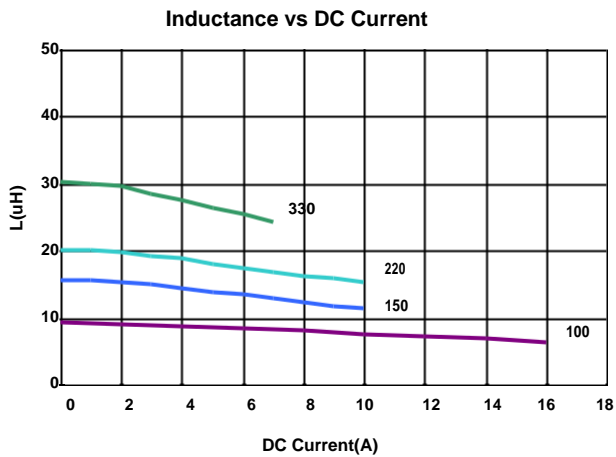

**Packaging Specifications**

**Tape Dimensions**

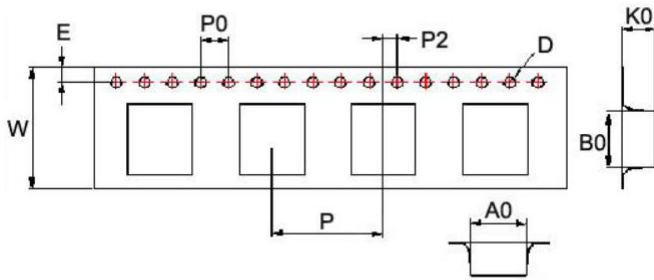

**Tape Material**

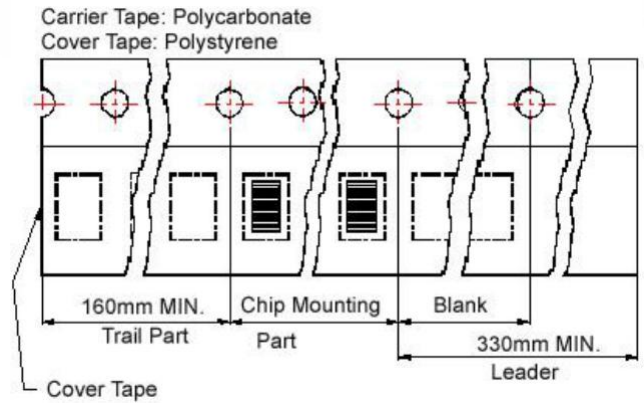

**Reel Dimensions**

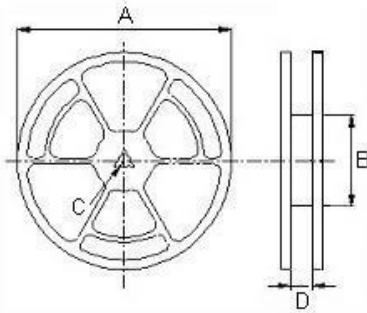

**Dimensions in mm**

TYPE	Tape Dimensions									Reel Dimensions				Quantity PCS / REEL
	A0	B0	K0	D	E	W	P	P0	P2	A	B	C	D	
BMRA00040412	4.6	5.0	1.5	1.55	1.75	12	8	4	2	330	100	13	13.4	2000
BMRA00040415	4.4	4.9	1.8	1.55	1.75	12	8	4	2	330	100	13	13.4	2000
BMRA00040420	4.3	4.9	2.4	1.55	1.75	12	8	4	2	330	100	13	13.4	2000
BMRB00050512	5.9	6.2	1.5	1.55	1.75	16	12	4	2	330	100	13	16.0	1000
BMRx00050515	5.7	6.1	1.9	1.55	1.75	16	12	4	2	330	100	13	16.0	1000
BMRB00050518-B	5.5	6.0	2.2	1.55	1.75	12	8	4	2	330	100	13	13.4	1000
BMRB00050518	5.9	6.2	2.2	1.55	1.75	16	12	4	2	330	100	13	16.0	1000
BMRA00050520	5.7	5.9	2.4	1.55	1.75	16	12	4	2	330	100	13	16.0	1000
BMRA00050530	5.9	6.2	3.4	1.55	1.75	16	12	4	2	330	100	13	16.0	1000
BMRB00060612	6.9	7.6	1.6	1.55	1.75	16	12	4	2	330	100	13	16.0	1000
BMRx00060615	6.9	7.6	2.1	1.55	1.75	16	12	4	2	330	100	13	16.0	1000
BMRB00060618	6.9	7.6	2.1	1.55	1.75	16	12	4	2	330	100	13	16.0	1000
BMRB00060624	7.0	7.6	2.7	1.55	1.75	16	12	4	2	330	100	13	16.0	1000
BMRx00060630	6.9	7.6	3.4	1.55	1.75	16	12	4	2	330	100	13	16.0	1000
BMRB00060650	6.9	7.6	5.4	1.55	1.75	16	12	4	2	330	100	13	16.0	1000
BMRG00101030	10.6	11.7	3.25	1.55	1.75	24	16	4	2	330	100	13	24.4	500
BMRF00101040	10.6	11.7	4.25	1.55	1.75	24	16	4	2	330	100	13	24.4	500
BMRF00131350	13	14	5.25	1.55	1.75	24	16	4	2	330	100	13	24.4	500
BMRG00131360	13	14	6.25	1.55	1.75	24	16	4	2	330	100	13	24.4	500