

# **USER MANUAL**

## **FAULT LOOP IMPEDANCE METER**

**MZC-304**

# MZC-304

Measuring terminals

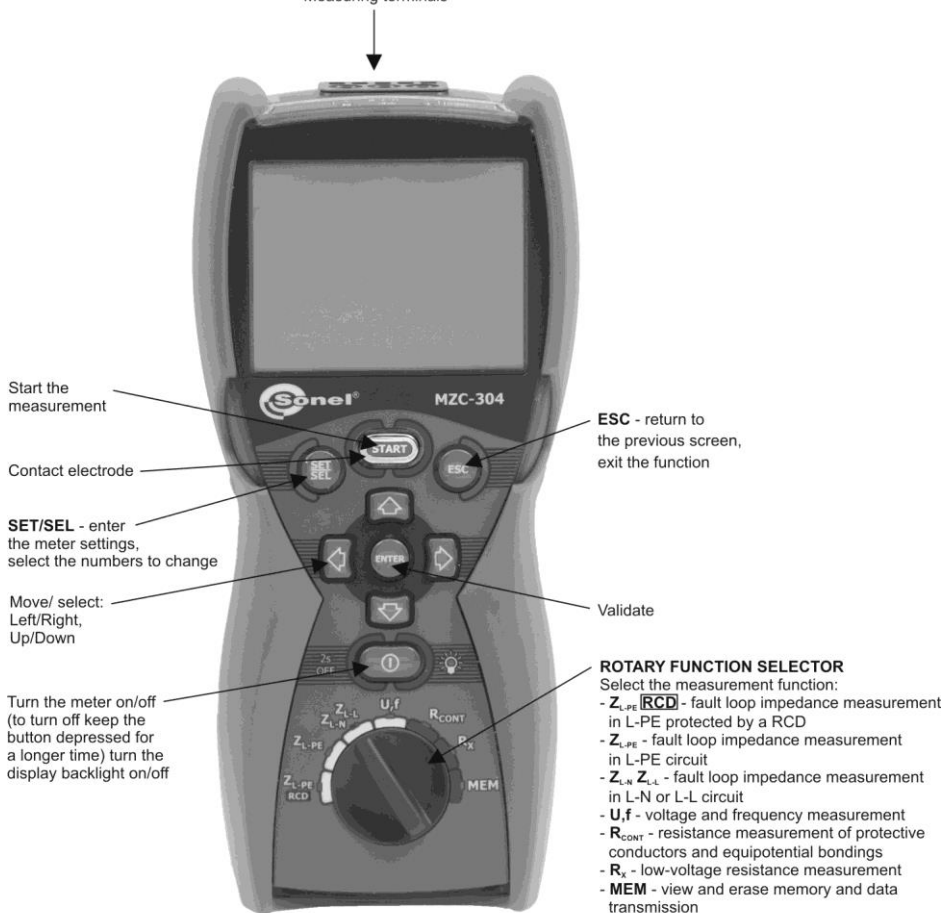



## **USER MANUAL**

# **FAULT LOOP IMPEDANCE METER MZC-304**



**SONEL S.A.  
Wokulskiego 11  
58-100 Świdnica  
Poland**

Version 2.08 05.10.2022

MZC-304 meter is a modern, high quality, easy to use and safe measuring device. Please acquaint yourself with this manual in order to avoid measuring errors and prevent possible problems in operation of the meter.

# CONTENTS

<b>1</b>	<b>Safety</b>	<b>4</b>
<b>2</b>	<b>Measurements</b>	<b>5</b>
2.1	Turning the meter on and off, display backlight	5
2.2	Selection of general measurement parameters	5
2.3	Remembering the last measurement result	6
2.4	Measurement of alternating voltage	6
2.5	Measurement of voltage and frequency	7
2.6	Checking correctness of PE (protective earth) connections	7
2.7	Measurement of fault loop parameters	8
2.7.1	Cable length selection	8
2.7.2	Prospective short-circuit current	9
2.7.3	Measurement of fault loop parameters in the L-N and L-L circuits	10
2.7.4	Measurement of fault loop parameters in the L-PE circuit	12
2.7.5	Measurement of short circuit loop impedance in L-PE circuit protected by a residual current device (RCD)	14
2.8	Measurement of resistance to earth	15
2.9	Low-voltage resistance measurement	16
2.9.1	Measurement of continuity of protective conductors and equipotential bondings with $\pm 200$ mA current	16
2.9.2	Low-current measurement of resistance	17
2.9.3	Compensation of test leads resistance - autozeroing	18
<b>3</b>	<b>Memory of measurement result data</b>	<b>19</b>
3.1	Storing the measurement result data in the memory	20
3.2	Changing the cell and bank number	22
3.3	Viewing memory data	22
3.4	Deleting memory data	23
3.4.1	Deleting bank data	23
3.4.2	Deleting the whole memory	24
3.5	Communication with a computer	25
3.5.1	Computer connection accessories	25
3.5.2	Data transmission with Bluetooth 4.2 module	25
3.5.3	Data transmission with OR-1 module	27
<b>4</b>	<b>Troubleshooting</b>	<b>28</b>
<b>5</b>	<b>Power supply of the meter</b>	<b>29</b>
5.1	Monitoring of the power supply voltage	29
5.2	Replacement of batteries	29
5.3	General rules of using the Nickel Metal Hydride (Ni-MH) batteries	30
<b>6</b>	<b>Cleaning and maintenance</b>	<b>30</b>
<b>7</b>	<b>Storage</b>	<b>31</b>
<b>8</b>	<b>Dismantling and disposal</b>	<b>31</b>
<b>9</b>	<b>Technical specifications</b>	<b>31</b>
9.1	Basic data	31
9.2	Additional information	34
9.2.1	Additional uncertainty according to IEC 61557-3 (Z)	34
9.2.2	Additional uncertainty according to IEC 61557-4 (R $\pm 200$ mA)	35
<b>10</b>	<b>Accessories</b>	<b>35</b>
10.1	Standard accessories	35
10.2	Optional accessories	35
<b>11</b>	<b>Manufacturer</b>	<b>36</b>
<b>12</b>	<b>Laboratory services</b>	<b>37</b>

# 1 Safety

The MZC-304 meter is designed for testing the protection against electric shock in the mains systems. The meter is used to make measurements which results determine the electrical installation safety level. Consequently, in order to ensure safe operation and correct measurement results, observe the following recommendations:

- Before you proceed to operate the meter, acquaint yourself thoroughly with the present manual and observe the safety regulations and recommendations of the manufacturer.
- Any application that differs from those specified in the present manual may cause damage of the instrument and a serious hazard to its user.
- The MZC-304 meters must be operated solely by appropriately qualified personnel with relevant certificates to perform measurements of electric installation. Operation of the instrument by unauthorized personnel may result in damage to the device and constitute a hazard to the user.
- Using this manual does not exclude the need to comply with occupational health and safety regulations and with other relevant fire regulations required during the performance of a particular type of work. Before starting the work with the device in special environments, e.g. potentially fire-risk/explosive environment, it is necessary to consult it with the person responsible for health and safety.
- It is unacceptable to operate the following:
  - ⇒ a damaged meter which is completely or partially out of order,
  - ⇒ leads with damaged insulation,
  - ⇒ a meter which has been stored too long in unsuitable conditions (for example is wet). When the meter is transferred from cold environment to warm and humid one, do not make measurements until the meter warms up to the ambient temperature (about 30 minutes).
- Remember that the **bat** message on the display means that the power supply voltage is too low and indicates the need to replace/ charge the batteries. The measurements performed with the meter with insufficient supply voltage have additional measuring errors which are impossible to be evaluated by the user and cannot be the basis to determine the correct protection of the tested installation.
- Do not leave the discharged batteries in the meter as they can leak and damage the instrument.
- Before starting the measurement, check if the leads are connected to correct measuring terminals.
- Never use the meters with open or only partially closed battery compartment cover and use only the power supplies specified in this manual.
- Repairs may be performed solely by an authorized service outlet.

## NOTE

**Use only standard and optional accessories intended for a given instrument which are listed in section 10. Using other accessories may cause damage of the measuring terminal and additional measuring errors.**

## Note:

**An attempt to install drivers in 64-bit Windows 8 may result in displaying "Installation failed" message.**

**Cause: Windows 8 by default blocks drivers without a digital signature.**

**Solution: Disable the driver signature enforcement in Windows.**

**Note:**

Due to continuous development of the meter software, the display view for some functions may be a bit different from the view shown in this manual.

## 2 Measurements



**WARNING:**

During the fault loop measurements, the earthed parts and parts accessible in the electrical installation being tested must not be touched.

**WARNING:**

During a measurement, switching of the range switch is forbidden because it may damage the meter and pose a threat to the user.

### 2.1 Turning the meter on and off, display backlight

Briefly press the  button to turn on the meter. Press it for a longer time to turn it off (**OFF** is displayed). Press briefly the  button during meter operation to turn on/off the display and keypad backlight.

### 2.2 Selection of general measurement parameters

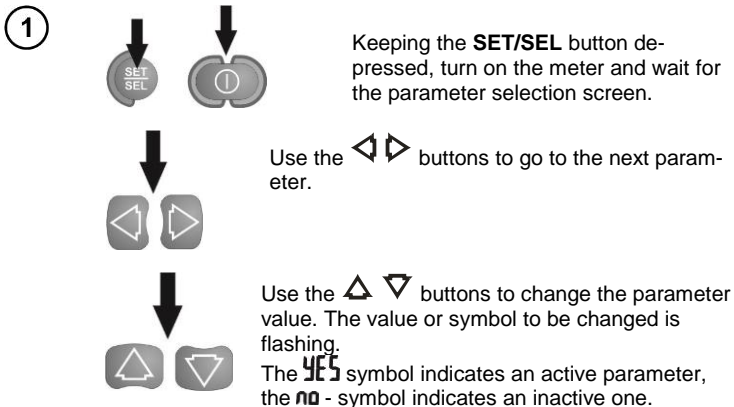

2

Set the parameters according to the following algorithm:

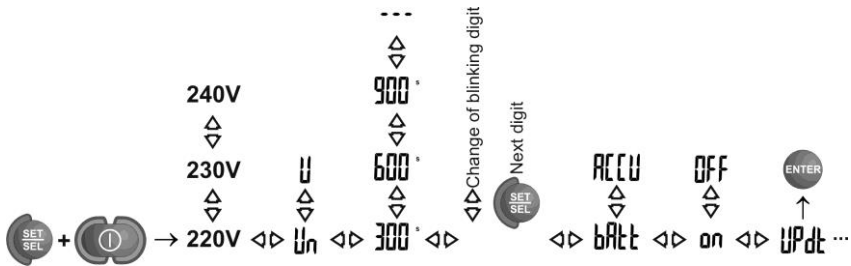

Parameter	Mains voltage	Voltage for calculating $I_K$ : rated/measured	Auto-OFF	Change PIN	Supply source selection	Buzzer	Software updating
Symbol(s)	$U_{n \text{ L-N}}$	$I_K$	OFF	$P_{in}$	SUPP	BEEP	?

3



Press **ENTER** to validate the changes and go to the measurement function,

or

4



...press **ESC** to go the measurement function without validating the changes.

## Note:

- Before the first measurements, select the mains rated voltage  $U_n$  (220/380V, 230/400V or 240/415V) used in the area where measurements are performed. This voltage value is used for calculating the values of prospective short-circuit current, if this option was chosen from the main menu.
- The --- symbol means that no auto-off time has been set.
- PIN settings - see section 3.5.2 **Data Transmission**.
- For software update proceed according to point 3.5.1. New software may be downloaded from [www.sonel.pl](http://www.sonel.pl).

## 2.3 Remembering the last measurement result

Result of the latest measurement is remembered by the meter until a next measurement is started, or measurement settings are changed, or the measuring function is changed by means of the rotary switch, or the meter is switched off. When you go to the output screen of a given function with the **ESC** button, you can recall this result by pressing **ENTER**. Similarly, you can view the latest measurement result after turning off and then turning on the meter.

## 2.4 Measurement of alternating voltage

The meter measures and displays alternating mains voltage in all measuring functions except R. This voltage is measured for the frequencies within the range of 45..65 Hz. The test leads should be connected as for a given measuring function.



## 2.5 Measurement of voltage and frequency

1



Set the rotary switch in the **U, f** position.

2



Read the result of measurement: the voltage on the secondary display field, the frequency on the principal.

## 2.6 Checking correctness of PE (protective earth) connections

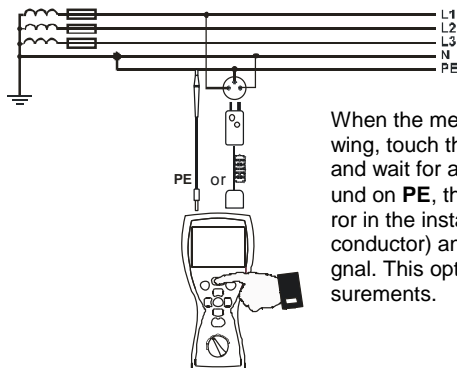

When the meter is connected as in the drawing, touch the contact electrode with your finger and wait for about 1 second. When voltage is found on **PE**, the meter displays the **PE** symbol (error in the installation; PE connected to the phase conductor) and generates a continuous audio signal. This option is available for the **Z<sub>L-PE</sub>** measurements.

### Note:

#### WARNING:

**When a dangerous voltage is detected on PE conductor, measurements must be immediately stopped and a fault in the installation must be removed.**

- The person making a measurement must ensure that he/she is standing on a non-insulated floor during the measurement; otherwise the result of the measurement may be incorrect.
- The threshold value, which triggers the signal of exceeded allowable voltage on PE conduit, is approximately 50 V.

## 2.7 Measurement of fault loop parameters



If there are residual current devices in the tested network, they should be bypassed by bridging for the period of impedance measurement. However, it should be remembered that the tested circuit is modified in this way and the obtained results may slightly differ from the actual results.

Each time after completion of measurements, modifications introduced to the installation for the period of measurements should be removed and operation of the residual current device should be checked.

The above remark does not apply to measurements of fault loop impedance with the use of the  $Z_{L-PE}$  **RCD** function



Measurements of fault loop impedance performed downstream of inverters are ineffective and their results are unreliable. This is due to the instability of internal impedance in inverter circuits during its operation. The measurements of fault loop impedance should not be performed directly downstream of inverters.

### 2.7.1 Cable length selection

1

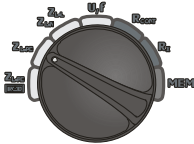

Turn the rotary switch to one of the loop impedance measurement ranges.

2

Set the parameters according to the following algorithm, and according to the rules described in general parameters setting.

**NOTE:** The WS-07, WS-05 and WS-01 cables are detected by the meter and it is then impossible to select the cable length (the  $\text{---}E$  symbol is displayed for WS-05 and WS-01 and symbol  $P_r$  for WS-07). Using cables terminated with banana plugs, before starting to measure, select the appropriate length of the phase conductor, compatible with the length of cable used for measurement.

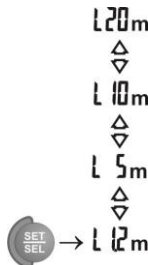

### Note:



Using cables from known manufacturers and selecting the correct length guarantees the declared measurement accuracy.

## 2.7.2 Prospective short-circuit current

The meter always measures impedance. The short-circuit current is calculated according to the following formula:

$$I_k = \frac{U}{Z_s}$$

where:

$Z_s$  - measured impedance,

$U$  - voltage that depends on settings of  $I_k$  (sec. 2.2 step ②):

$I_k(U_n)$	$U = U_n$
$I_k(U_0)$	$U = U_0$ for $U_0 < U_n$
	$U = U_n$ for $U_0 \geq U_n$

where:

$U_n$  – nominal voltage of the network,

$U_0$  – voltage measured by the meter.

On the basis of  $U_n$  rated voltage selected (section 2.1), the meter automatically recognizes the measurement at phase-to-neutral or phase-to-phase voltage and takes it into account in the calculations.

If the voltage of the tested mains is outside the tolerance range, the meter will not be able to determine a proper rated voltage for the short-circuit current calculation. In such a case, horizontal dashes will be displayed instead a short-circuit current value. The following diagram shows voltage ranges for which short-circuit current value is calculated.

Voltage range for which the impedance is measured

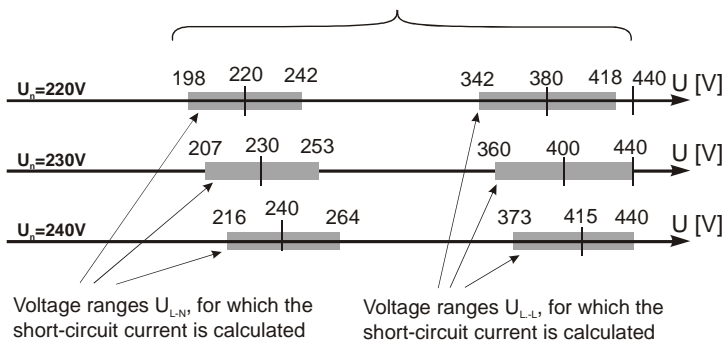

## 2.7.3 Measurement of fault loop parameters in the L-N and L-L circuits

1

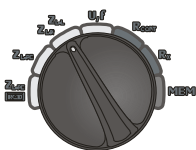

Turn on the meter.  
Turn the rotary switch to the **Z<sub>L-L</sub>** **Z<sub>L-N</sub>** position.

2

Depending on needs, select cable length according to section 2.7.1.

3

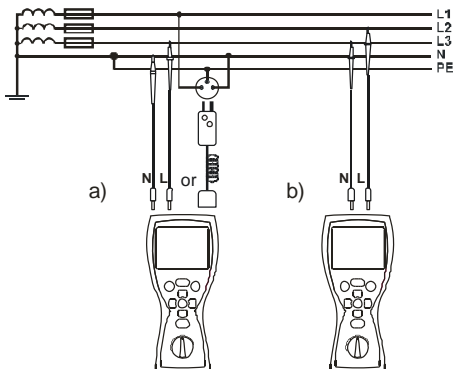

Connect test leads according to the drawing  
a) for measurement in the L-N circuit  
or  
b) for measurement in the L-L circuit

4

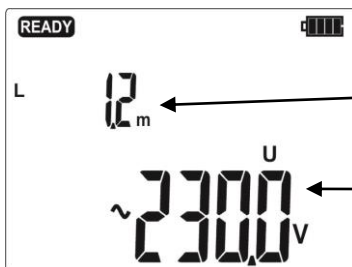

The meter is ready for measurement.

Phase conductor length or the  $\text{---}E$  or  $P_r$  symbol.

$U_{L-N}$  or  $U_{L-L}$  voltage

5



Make the measurement by pressing the **START** button.

6



Read the main measurement result: fault loop impedance  $Z_s$  and the mains voltage at the time of measurement.

7



To read additional results, press the  button.

8

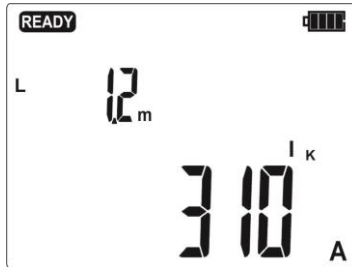

$I_k$   
short-circuit  
current

9

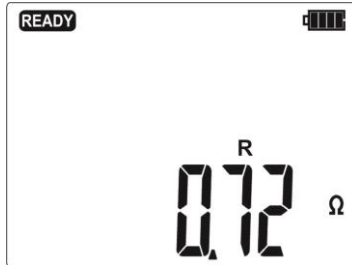

$R$   
fault loop  
resistance

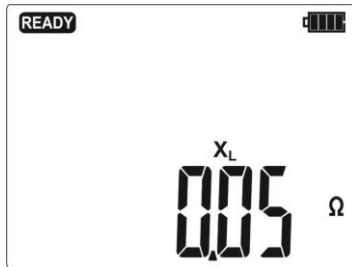

$X_L$   
fault loop  
reactance

### Note:

- Enter the result into memory (see sections 3.1 and 3.2) or press **ESC** to return to go to the voltage measurement.
- When many measurements are made at short time intervals, the meter may emit a large amount of heat. As a result of this, the enclosure of the device may become hot. This is normal and the meter is equipped with the protection against excessive temperature.
- Minimum interval between successive measurements is 5 seconds. This is controlled by the meter which displays the **READY** message informing that the measurement can be made.



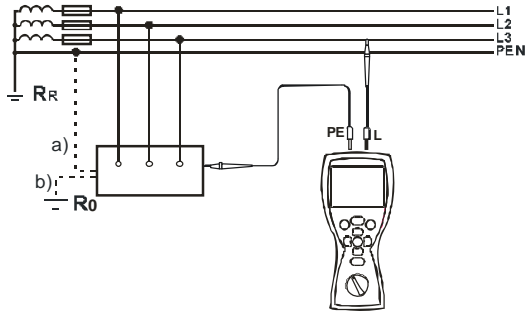

Checking effectiveness of protection against electric shock of the enclosure in case of: a) TN b) TT.

4

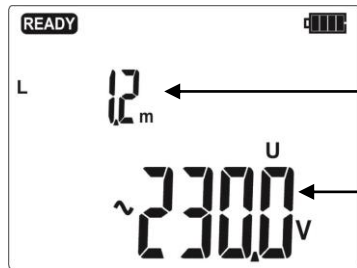

The meter is ready for measurement.

Phase conductor length or the --E symbol.

$U_{L-PE}$  voltage

5



Make measurement by pressing the **START** button.

Remaining issues connected with the measurements are the same as those described for measurements in L-N circuit or L-L circuit.

**Note:**

Double lead measurement is possible when a test lead other than the lead with a mains socket is selected.

**Additional information displayed by the meter**

Error messages and information - as for the L-N and L-L measurement.





## Additional information displayed by the meter

Error messages and information - as for the L-N and L-L measurement.

### 2.8 Measurement of resistance to earth

The MPI-502 meter can be used for approximate measurements of resistance to earth. For this purpose, the phase conductor is used as a secondary source of voltage which generates test current. Connection diagram for the instrument for such measurement in the TN-C, TN-S and TT systems is shown in the figure below.

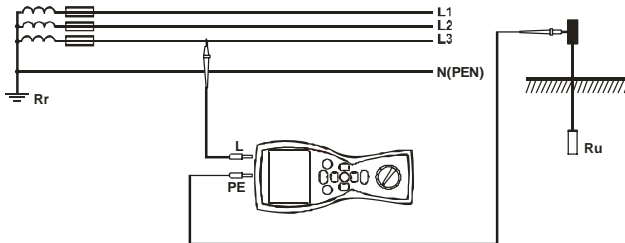

During the measurement, check the connections of the measured earth electrode with the electrical installation. For correct measurement, the tested earthing system should be disconnected from the electrical installation (N and PE conductors). If you want to measure the earth electrode, for instance in the TN-C-S system and simultaneously use the phase of the same system as a secondary source of current, disconnect the PE and N conductors from the measured earth electrode (see figure below). Otherwise, the meter will measure an incorrect value (the test current will flow not only through the measured earthing system).

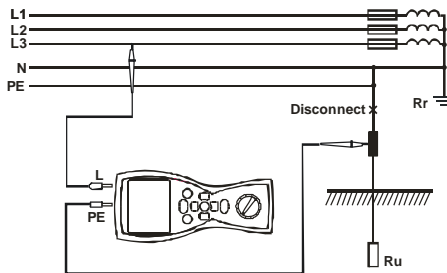

#### Note:

##### WARNING:

**Disconnection of protective conductors is a serious life hazard for the staff performing the measurements and also third parties. When the measurements are completed, the protective and neutral conductors MUST be reconnected.**

- If it is not possible to disconnect the conductors, use an earth resistance meter from the MRU range.
- As the measurement result is the sum of impedances of the measured earth electrode, working earthing system, source and phase conductor, it contains a positive error. However, if such error does not exceed a limit value for the tested earthing system, it can be concluded that the earthing has been made correctly and there is no need for a more accurate measurement methods.



## Additional information displayed by the meter

	The tested facility is live. The measurement is blocked. <b>Immediately disconnect the meter from the facility (both conductors)!</b>
	Huge noise in the system during the measurement. The measurement result may be affected by a large, unspecified error.
> 400 <sup>Ω</sup>	Measuring range is exceeded.

### 2.9.2 Low-current measurement of resistance

①

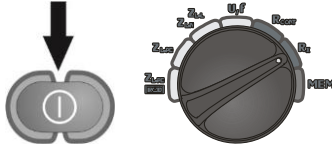

Turn on the meter.  
Turn the rotary switch to the  $R_x$  position.

②

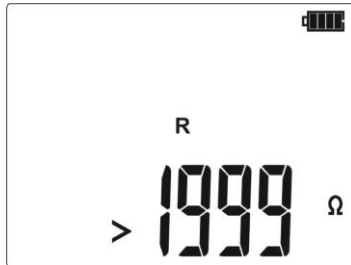

The meter is ready for measurement.

③

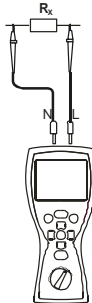

Connect test leads according to the drawing.

④

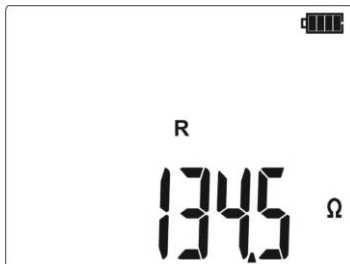

Read the measurement result.

## Additional information displayed by the meter

<b>UDDET</b>	The tested facility is live. The measurement is blocked. <b>Immediately disconnect the meter from the facility (both conductors)!</b>
<b>NOISE!</b>	Huge noise in the system during the measurement. The measurement result may be affected by a large, unspecified error.
> 1999 °	Measuring range is exceeded.

### 2.9.3 Compensation of test leads resistance - autozeroing

①

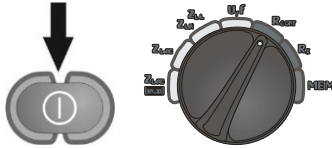

Turn on the meter.  
Turn the rotary switch to the  $R_{CONT}$  or  $R_x$  position

②

Set the autozeroing according to the following algorithm.



③



Short the test leads.

④



Activate the autozeroing by pressing the **START** button.

⑤

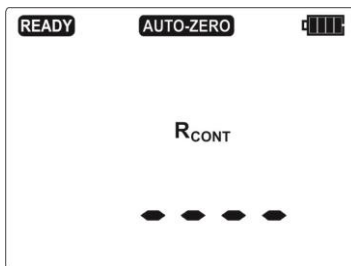

After completion of autozeroing, the meter automatically switches to the "ready for measurement" mode.

## Note:

- The **AUTO-ZERO** message remains on the display after switching into one of the measurement functions (resistance or continuity measurement) indicating that the measurement is made with compensated least leads resistance.

- To remove the compensation, perform the above-mentioned activities but with open test leads.

When you enter the measurement screen, the **AUTO-ZERO** message will not be displayed.

## Additional information displayed by the meter

	The tested facility is live. The measurement is blocked. <b>Immediately disconnect the meter from the facility (both conductors)!</b>
-----------------------------------------------------------------------------------	------------------------------------------------------------------------------------------------------------------------------------------

## 3 Memory of measurement result data

MZC-304 meters are equipped with the memory that can store 10000 single measurement results. The whole memory is divided into 10 memory banks, each of them containing 99 memory cells. Thanks to dynamic memory allocation, each of the memory cells can contain different quantity of single measurement results, depending on the needs. Optimal use of the memory can be ensured in this way. Each measurement result can be stored in a memory cell marked with a selected number and in a selected memory bank. Thanks to this, the user of the meter can, at his/her discretion, assign memory cell numbers to individual measurement points and the memory bank numbers to individual facilities. The user can also perform measurements in any sequence and repeat them without losing other data.

Memory of measurement result data **is not deleted** when the meter is switched off. Thanks to this, the data can be later read or sent to a computer. The number of a current memory cell or memory bank is not changed either.

## Note:

- Results of measurements performed for all measuring functions can be stored in one memory cell.

- After each entry of the measurement result to the cell, its number is automatically incremented. Set the appropriate cell number to allow entering to a single cell of successive measurement results relating to a given measuring point (facility).

- Only the results of measurements activated by pressing the **START** button can be stored in the memory (except autozeroing in low-voltage resistance measurement).

- It is recommended to delete the memory after reading the data or before performing a new series of measurements that may be stored in the same memory cells as the previous ones.

### 3.1 Storing the measurement result data in the memory

①



Press **ENTER** after completion of the measurement.  
The meter is in the memory storing mode.

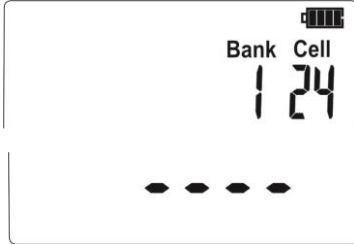

Cell is empty.



The cell contains the result of the same type which is to be entered.



The cell contains the measurement results of the displayed types.



The cell contains the measurement results of all types.

②

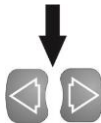

Use ◀ the ▶ buttons to view different types of results and their components.

3



Select the bank and cell number (see section 3.2) or leave the current number. Then press **ENTER** again. The following screen appears for a moment, accompanied by three short beeps, and then the meter returns to display the last measurement result.

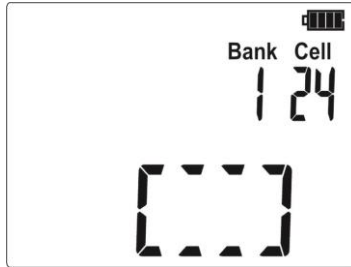

4

An attempt to overwrite causes the warning symbol to appear.



5

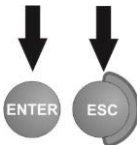

Press **ENTER** to overwrite the result or **ESC** to abort.

## Note:

- Complete set of results (main result and supplementary results) for a given measuring function and measurement settings are stored in the memory.

### 3.2 Changing the cell and bank number

- ①



Press **ENTER** after completion of the measurement.  
The meter is in the memory storing mode.



The cell number is flashing.  
To change, use the  $\blacktriangle$  and  $\blacktriangledown$  buttons.
- ②



Press **SET/SEL**.



The bank number is flashing.  
To change, use the  $\blacktriangle$  and  $\blacktriangledown$  buttons.
- ③



Press **SET/SEL**.  
The cell number is flashing again.

### 3.3 Viewing memory data

- ①

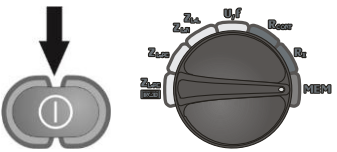

Turn on the meter.  
Turn the rotary switch to the **MEM** position.



The content of the last saved cell appears.  
The cell number is flashing.

Use the **SET/SEL** buttons and then the  $\blacktriangle$   $\blacktriangledown$  buttons to change the number of the bank and cell which intent you want to view.  
If the bank or cell number is flashing, its number can be changed.
- ②

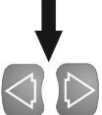

Use the  $\blacktriangleleft$  and  $\blacktriangleright$  buttons to view different types of results and their components.



## 3.4 Deleting memory data

### 3.4.1 Deleting bank data

①

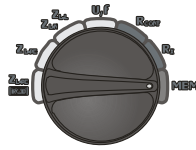

Turn on the meter.  
Turn the rotary switch to the **MEM** position.

②

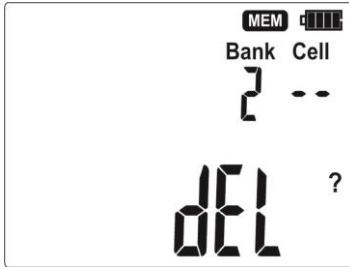

Set the bank number to be deleted according to section 3.2.  
Set the cell number to -- (before 1). The **del** symbol appears which indicates the readiness to delete.

③



Press **ENTER**.

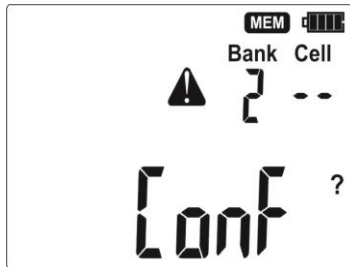

The **Conf** and **!** symbols appear, asking you to confirm deletion.

④



Press **ENTER** to start deleting or **ESC** to abort.

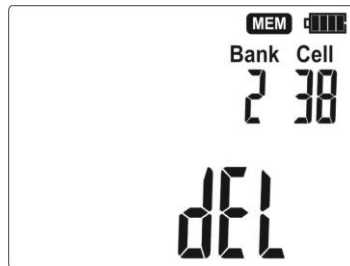

The deletion progress is shown on the display as scrolling cell numbers. When deletion is complete, the meter generates three short beeps and sets the cell number to 1.

### 3.4.2 Deleting the whole memory

①

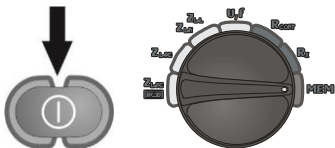

Turn on the meter.  
Turn the rotary switch to the **MEM** position.

②

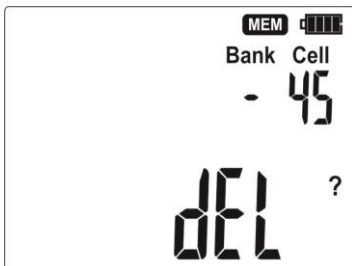

Set the bank number to **0** (before 0). The symbol **del** appears which indicates the readiness to delete.

③



Press **ENTER**.



The **Conf** and **!** symbols appear, asking you to confirm deletion.

④



Press **ENTER** to start deleting or **ESC** to abort.

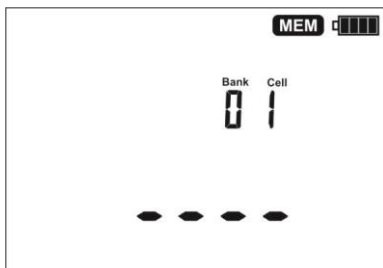

The deletion progress is shown on the display as scrolling bank and cell numbers. When deletion is complete, the meter generates three short beeps and sets the cell number to 1.



3



Press **ENTER**, the radio transmission screen will appear.

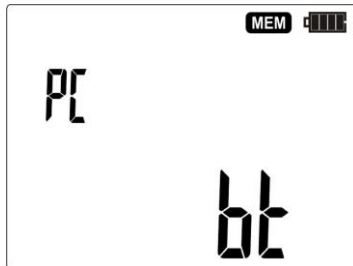

- 4 Connect Bluetooth module to the USB socket of the PC, unless it is integrated into the PC.
- 5 During the process of pairing the meter with a PC enter PIN code compatible with the PIN code of the meter defined in main settings.
- 6 On the computer start data storing programme. To transmit the data, follow the instruction from your software.

Press **ESC** to exit the transmission mode.

## Note:



Standard pin for Bluetooth is the „0123“. Settings in the meter according to section 2.2.

### 3.5.3 Data transmission with OR-1 module

The feature is available in meters with serial number prefix **AF**.

①

Connect the OR-1 module to the USB socket of the PC.

②

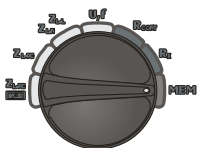

Turn on the meter.  
Turn the rotary switch to the **MEM** position.

③



Press **SET/SEL** for about 2 seconds;  
the meter will ask you to activate the  
radio transmission.



④



Press **ENTER**, the radio transmission  
screen will appear.



To transmit data, follow the instructions of the software.  
Press **ESC** to exit the transmission mode.

#### Note:



Standard pin for OR-1 is the „123“. Settings in the meter according to section 2.2.

## 4 Troubleshooting

Before returning the instrument for repair, call the service, perhaps the meter is not damaged and the problem has occurred for another reason.

The meter repairs should be carried out only in the outlets authorized by the manufacturer.

The following table describes the recommended procedure in certain situations that occur when using the meter.

Measuring function	Symptom	Cause	Action
<b>All</b>	The meter will not start after pressing the <b>Ⓢ</b> button. The <b>batt</b> symbol is displayed during the voltage measurement. Meter turns off during the initial test.	Discharged or incorrectly placed batteries/ rechargeable batteries	Check if the batteries are placed correctly, replace and/or recharge the batteries. If this does not help, send the meter for servicing.
	Measurement errors after moving the meter from cold environment to warm and humid environment.	No acclimatization	Do not perform the measurements until the meter reaches the ambient temperature (about 30 minutes) and dries.
<b>Fault loop</b>	Successive results obtained in the same measuring point are significantly different from each other	Incorrect connections in the tested mains.	Check the connections and remove defects
		Mains with high noise or unstable voltage	Perform a larger number of measurements, average the results
	The meter indicates the values close to zero or zero irrespective of the location of the measurement and these values are significantly different than expected.	Incorrectly selected test leads in the meter settings.	
	The <b>PE</b> symbol does not appear, although the voltage between the contact electrode and the <b>PE</b> conductor exceeds the detector threshold (about 50V)	Contact electrode is not functioning correctly or the meter input circuits are damaged	Return the meter for servicing; the use of a malfunctioning meter is <b>unacceptable</b>
Rotary switch in a wrong position.		Contact electrode is active for the measurements of the $Z_{L-PE}$ fault loop parameters.	

## 5 Power supply of the meter

### 5.1 Monitoring of the power supply voltage

The charge level of the batteries or rechargeable batteries is indicated by the symbol in the right upper corner of the display on a current basis:

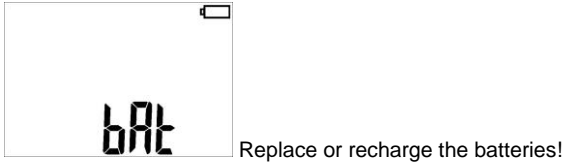
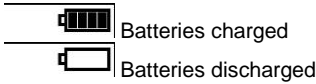

Note:

- The **bat** symbol in the display means that the supply voltage is too low and indicates that the batteries must be replaced or recharged,
- Measurements performed with an insufficient supply voltage feature additional errors which the user is unable to evaluate.

### 5.2 Replacement of batteries

The MZC-304 is powered by four LR6 batteries or AA size rechargeable batteries. They are placed in the compartment at the bottom of the enclosure.

**WARNING:**  
Before replacing the batteries, disconnect the test leads from the meter.

To replace the batteries:

1. Disconnect the leads from the measuring circuit and turn off the meter;
2. Remove the screw that secures the battery cover (the bottom of the enclosure);
3. Replace all batteries. Observe the correct polarity when putting new batteries ("-" on the elastic part of the contact plate). Reversed polarity will not damage the meter or the batteries, but the meter will not work;
4. Place and tighten the battery compartment cover.

**NOTE!**  
After replacing the batteries, always set the power supply type in the main MENU. The correct charge indication depends on this setting (the discharge characteristics of disposable and rechargeable batteries are different).

**NOTE!**  
Have the meter serviced in case of battery leakage inside the compartment.

Batteries must be recharged in an external charger.

### **5.3 General rules of using the Nickel Metal Hydride (Ni-MH) batteries**

- If you are not going to use the instrument for a longer time, remove the rechargeable batteries and store them separately.
- Store the rechargeable batteries in a dry, cool and well ventilated place and protect them from direct sunlight. The long storage temperature should be below 30 degrees C. If the batteries are stored long at high temperatures, the chemical processes may reduce their life.
- The NiMH rechargeable batteries usually withstand 500-1000 charging cycles. Such batteries achieve full capacity after forming (2-3 discharging and charging cycles). The most important factor which influences the battery life is the discharge level. The deeper the discharge level, the shorter the battery life.
- The memory effect appears in the NiMH batteries in a limited scope. These batteries can be recharged without more serious consequences. It is, however, recommended to discharge them completely every few cycles.
- During the storage of the Ni-MH rechargeable batteries, they are subject to self-discharge process at the rate of about 30% a month. Keeping the batteries at high temperatures may accelerate this process even two times. In order not to allow an excessive discharging of the batteries (after which the forming will be needed), recharge the batteries once in a while (even unused batteries).
- Modern, fast chargers detect too low and too high temperature of the batteries and respond accordingly. If the temperature is too low, the charging process should not start as it might irrevocably damage a rechargeable battery. The battery temperature increase is a signal to stop the charging and is typical. In addition to faster temperature increase of a battery which will not be fully charged, charging at high ambient temperatures results, however, in a reduced life.
- Remember that with fast charging, the batteries are charged to about 80% of their capacity; better results can be achieved by continuing the charging process: the charger then goes into the small current charging mode and after a few hours the batteries are fully charged.
- Do not charge and do not use the batteries at extreme temperatures as they reduce the life of batteries. Avoid using the battery-powered devices in very hot places. The rated operating temperature must be observed at all times.

## **6 Cleaning and maintenance**

**NOTE!**  
**Use only the maintenance methods presented by the manufacturer in this manual.**

Clean the meter casing and the case with a wet cloth, using generally available detergents. Do not use any solvents and cleaning media which could scratch the casing (powder, paste, etc.).

The probes can be cleaned with water and then wiped dry. Before longer storage, it is recommended to lubricate the probes with any machine grease.

Clean the spools and leads with water and detergents, then wipe dry.

The meter electronic system is maintenance free.



## 7 Storage

When storing the instrument, observe the following recommendations:

- disconnect all leads from the meter,
- thoroughly clean the meter and all accessories,
- wind long test leads onto the spools,
- if you are not going to use the instrument for a longer time, remove the batteries,
- during a prolonged storage recharge the batteries from time to time to prevent total discharging.

## 8 Dismantling and disposal

Used electric and electronic equipment should be collected selectively, i.e. not placed with other types of waste.

Used electronic equipment shall be sent to the collection point according to the Used Electric and Electronic Equipment Act.

Before sending the instrument to the collection point, do not dismantle any parts by yourself.

Observe local regulations on disposal of packagings and used batteries.

## 9 Technical specifications

### 9.1 Basic data

⇒ Abbreviation "m.v." used in the specification of measurement uncertainty means a standard measured value.

#### Voltage measurement

Display range	Resolution	Measurement uncertainty
0.0...299.9 V	0,1 V	$\pm(2\% \text{ m.v.} + 6 \text{ digits})$
300...500 V	1 V	$\pm(2\% \text{ m.v.} + 2 \text{ digits})$

- Frequency range: 45...65 Hz

#### Frequency measurement

Display range	Resolution	Measurement uncertainty
45.0...65.0 Hz	0,1 Hz	$\pm(0.1\% \text{ m.v.} + 1 \text{ digit})$

- Voltage range: 50 .. 500 V

#### Measurement of fault loop impedance $Z_{L-PE}$ , $Z_{L-N}$ , $Z_{L-L}$

##### Measurement of fault loop impedance $Z_s$

Test range according to IEC 61557:

Test lead	Measurement range $Z_s$
1,2 m	0.13...1999 $\Omega$
5 m	0.17...1999 $\Omega$
10 m	0.21...1999 $\Omega$
20 m	0.29...1999 $\Omega$
WS-01, -05, -07	0.19...1999 $\Omega$

Display range:

Display range	Resolution	Measurement uncertainty
0.00...19.99 Ω	0,01 Ω	±(5% m.v. + 3 digits)
20.0...199.9 Ω	0,1 Ω	±(5% m.v. + 3 digits)
200...1999 Ω	1 Ω	±(5% m.v. + 3 digits)

- Rated operating voltage  $U_{nL-N}/ U_{nL-L}$ : 220/380V, 230/400V, 240/415V
- Operating voltage range: 180...270V (for  $Z_{L-PE}$  i  $Z_{L-N}$ ) and 180...460V (for  $Z_{L-L}$ )
- Rated mains frequency  $f_n$ : 50Hz, 60Hz
- Operating frequency range: 45...65Hz
- Maximum test current: 7.6 A for 230 (3x10ms), 13.3 A for 400V (3x10ms)
- Control of correctness of PE terminal connection by means of a contact electrode (applicable to  $Z_{L-PE}$ )

#### Fault loop resistance $R_s$ and fault loop reactance $X_s$

Display range	Resolution	Measurement uncertainty
0.00...19.99 Ω	0.01 Ω	±(5% + 5 digits) of $Z_s$ value
20.0...199.9 Ω	0.1 Ω	±(5% + 5 digits) of $Z_s$ value

- Calculated and displayed for  $Z_S < 200\Omega$

#### Short-circuit current $I_k$

Test range according to IEC 61557 can be calculated on the basis of test ranges  $Z_s$  and rated voltages.

Display range	Resolution	Measurement uncertainty
0.110...1.999 A	0.001 A	Calculated on the basis of uncertainty for fault loop
2.00...19.99 A	0.01 A	
20.0...199.9 A	0.1 A	
200...1999 A	1 A	
2.00...19.99 kA	0.01 kA	
20.0...40.0 kA	0.1 kA	

- Prospective fault current calculated and displayed by the meter may slightly differ from the value calculated by the user with a calculator, basing on the displayed value of the impedance, because the meter calculates the current from unrounded value of fault loop impedance (which is used for displaying). As the correct value, consider  $I_k$  current value, displayed by the meter or by firmware.

#### Measurement of fault loop impedance $Z_{L-PE}$ **RCD** (without RCD tripping)

##### Measurement of fault loop impedance $Z_s$

Measuring range acc. to IEC 61557: 0,5...1999Ω for 1.2m leads, WS01 i WS05 and 0.51...1999Ω for 5m, 10m and 20m leads

Display range	Resolution	Measurement uncertainty
0.00...19.99 Ω	0,01 Ω	±(6% m.v. + 10 digits)
20.0...199.9 Ω	0,1 Ω	±(6% m.v. + 5 digits)
200...1999 Ω	1 Ω	±(6% m.v. + 5 digits)

- It will not trip RCD's of  $I_{\Delta n} \geq 30$  mA
- Rated operating voltage  $U_n$ : 220V, 230V, 240V
- Operating voltage range: 180...270V
- Rated mains frequency  $f_n$ : 50Hz, 60Hz
- Operating frequency range: 45...65Hz
- Control of correctness of PE terminal connection by means of a contact electrode

### Fault loop resistance $R_S$ and fault loop reactance $X_S$

Display range	Resolution	Measurement uncertainty
0.00...19.99 $\Omega$	0.01 $\Omega$	$\pm(6\% + 10 \text{ digits})$ of $Z_S$ value
20.0...199.9 $\Omega$	0.1 $\Omega$	$\pm(6\% + 5 \text{ digits})$ of $Z_S$ value

- Calculated and displayed for  $Z_S < 20\Omega$

### Short-circuit current $I_k$

Test range according to IEC 61557 can be calculated on the basis of test ranges  $Z_S$  and rated voltages.

Display range	Resolution	Measurement uncertainty
0.110...1.999 A	0.001 A	Calculated on the basis of uncertainty for fault loop
2.00...19.99 A	0.01 A	
20.0...199.9 A	0.1 A	
200...1999 A	1 A	
2.00...19.99 kA	0.01 kA	
20.0...24.0 kA	0.1 kA	

- Prospective fault current calculated and displayed by the meter may slightly differ from the value calculated by the user with a calculator, basing on the displayed value of the impedance, because the meter calculates the current from unrounded value of fault loop impedance (which is used for displaying). As the correct value, consider  $I_k$  current value, displayed by the meter or by firmware.

### Low-voltage continuity and resistance measurement

#### Measurement of continuity of protective conductors and equipotential bondings with $\pm 200$ mA current

Measurement range according to IEC 61557-4: 0.12...400 $\Omega$

Display range	Resolution	Measurement uncertainty
0.00...19.99 $\Omega$	0.01 $\Omega$	$\pm(2\% \text{ m.v.} + 3 \text{ digits})$
20.0...199.9 $\Omega$	0.1 $\Omega$	
200...400 $\Omega$	1 $\Omega$	

- Voltage at open terminals: 4...9V
- Output current at  $R < 2\Omega$ : min 200mA ( $I_{SC}$ : 200...250mA)
- Compensation of test leads resistance
- Measurements for both current polarizations

#### Low-current resistance measurement

Display range	Resolution	Measurement uncertainty
0.0...199.9 $\Omega$	0.1 $\Omega$	$\pm(3\% \text{ m.v.} + 3 \text{ digits})$
200...1999 $\Omega$	1 $\Omega$	

- Voltage at open terminals: 4...9V
- Short-circuit current  $I_{SC}$ : 8...15mA
- Audio signal for measured resistance  $< 30\Omega \pm 50\%$
- Compensation of test leads resistance

## Other technical specification

- a) type of insulation ..... double, EN 61010-1 and IEC 61557 compliant
- b) measurement category ..... IV 300V (III 600V), EN 61010-1 compliant
- c) degree of protection of enclosure acc. to EN 60529 ..... IP67
- d) meter power supply ..... LR6 alkaline batteries or NiMH rechargeable batteries size AA (4 pcs)
- e) dimensions ..... 220x98x58 mm
- f) meter weight ..... about 0.6 kg
- g) storage temperature ..... -20...+70°C
- h) operating temperature ..... 0...+50°C
- i) humidity ..... 20...90%
- j) reference temperature ..... +23 ± 2°C
- k) reference humidity ..... 40...60%
- l) altitude (above sea level) ..... <2000 m
- m) time to Auto-OFF ..... 120 seconds
- n) number of measurements Z (for rechargeable batteries) ..... >5000 (2 measurements per minute)
- o) display ..... LCD segment
- p) memory of measurement results ..... 990 cells, 10000 entries
- q) data transmission ..... radio link, waveband ISM 433 MHz
- r) quality standard ..... development, design and manufacturing are ISO 9001 compliant
- s) the device meets the requirements of the IEC 61557 standard
- t) the product meets the EMC requirements (immunity for industrial environment) according to the following standards ..... EN 61326-1 and EN 61326-2-2

**Note:**

SONEL S.A. hereby declares that the radio device type MZC-304 complies with Directive 2014/53/EU. The full text of the EU Declaration of Conformity is available at the following website address: <https://sonel.pl/en/download/declaration-of-conformity/>

## 9.2 Additional information

Information about additional uncertainty is useful mainly when the meter is used in untypical conditions and for the measurements laboratories during calibration.

### 9.2.1 Additional uncertainty according to IEC 61557-3 (Z)

Influencing value	Designation	Additional uncertainty
Location	E <sub>1</sub>	0%
Supply voltage	E <sub>2</sub>	0% ( <b>BAT</b> is not displayed)
Temperature 0...35°C	E <sub>3</sub>	1.2 m lead – 0 Ω 5 m lead – 0.011 Ω 10 m lead – 0.019 Ω 20 m lead – 0.035 Ω WS-01, WS-05, WS-07 leads – 0.015 Ω
Phase angle 0..30° at the bottom of measurement range	E <sub>6,2</sub>	0,6%
Frequency 99%..101%	E <sub>7</sub>	0%
Mains voltage 85%..110%	E <sub>8</sub>	0%
Harmonics	E <sub>9</sub>	0%
DC component	E <sub>10</sub>	0%

## 9.2.2 Additional uncertainty according to IEC 61557-4 (R ±200 mA)

Influencing value	Designation	Additional uncertainty
Location	E <sub>1</sub>	0%
Supply voltage	E <sub>2</sub>	0,5% ( <b>BAT</b> is not displayed)
Temperature 0...35°C	E <sub>3</sub>	1,5%

## 10 Accessories

The current list of accessories can be found on the manufacturer's website.

### 10.1 Standard accessories

Standard set of equipment supplied by the manufacturer includes:

- MZC-304 meter
- set of test leads:
  - adapter WS-05 with angle plug UNI-SCHUKO (CAT III 300V) – **WAADAWS05**
  - leads 1,2m (CAT III 1000V) with banana plugs – 3 pcs (yellow **WAPRZ1X2YEBB**, red-**WAPRZ1X2REBB** and blue - **WAPRZ1X2BUBB**)
- accessories
  - crocodile clip (CAT III 1000V) – 1 pc. (yellow K02 – **WAKROYE20K02**)
  - test prod with banana socket (CAT II 1000V) – 2 pcs. (red- **WASONREOGB1** and blue – **WASONBUOGB1**)
- rigid hanger with a hook – **WAPOZUCH1**
- carrying case for the meter and accessories – **WAFUTM6**
- meter harness – **WAPOZSZE4**
- user manual
- factory calibration certificate
- 4 LR6 batteries

### 10.2 Optional accessories

Additionally, the following items that are not included in the scope of standard equipment can be purchased from the manufacturer or the distributors:

**WAPRZ005REBB**  
**WAPRZ010REBB**  
**WAPRZ020REBB**



- 5 / 10 / 20 m lead, red

**WAADAWS01**



- WS-01 adapter for triggering the measurement with the UNI-Schuko plug

#### WASONYEOGB1



- test prod with banana socket

#### WAADAWS07



- WS-07 adapter for measuring  $Z_{L-N}$

#### WAADAAGT16P - five-wire version

#### WAADAAGT16C - four-wire version



- AGT-16P adapter for three-phase sockets

#### WAKRORE20K02



- crocodile, red

#### WAADAAGT63P - five-wire version



#### AGT-63P adapter for three-phase sockets

#### WAADAAGT32P - five-wire version

#### WAADAAGT32C - four-wire version



- AGT-32P adapter for three-phase sockets

- Calibration certificate with accreditation

## 11 Manufacturer

The manufacturer of the device and provider of warranty and post-warranty service:

#### SONEL S.A.

Wokulskiego 11

58-100 Świdnica

Poland

tel. +48 74 858 38 60

fax +48 74 858 38 09

E-mail: [export@sonel.pl](mailto:export@sonel.pl)

Web page: [www.sonel.pl](http://www.sonel.pl)

#### NOTE

Service repairs must be performed solely by the manufacturer.

## 12 Laboratory services

SONEL Testing and Calibration Laboratory has been accredited by the Polish Center for Accreditation (PCA) - certificate no. AP 173.

Laboratory offers calibration for the following instruments that are used for measuring electrical and non-electrical parameters.



AP 173

### ● METERS FOR MEASUREMENTS OF ELECTRICAL PARAMETERS

- voltage meters,
- current meters (including clamp meters),
- resistance meters,
- insulation resistance meters,
- earth resistance and resistivity meters,
- RCD meters,
- short-circuit loop impedance meters,
- power quality analyzers,
- portable appliance testers (PAT),
- power meters,
- multimeters,
- multifunction meters covering the functions of the above-mentioned instruments,

### ● ELECTRICAL STANDARDS

- calibrators,
- resistance standards,

### ● METERS FOR MEASUREMENTS OF NON-ELECTRICAL PARAMETERS

- pyrometers,
- thermal imagers,
- luxmeters.

The Calibration Certificate is a document that presents a relation between the calibration standard of known accuracy and meter indications with associated measurement uncertainties. The calibration standards are normally traceable to the national standard held by the National Metrological Institute.

According to ILAC-G24 „Guidelines for determination of calibration intervals of measuring instruments”, SONEL S.A. recommends periodical metrological inspection of the instruments it manufactures no less frequently than once every 12 months.

For new instruments provided with the Calibration Certificate or Validation Certificate at the factory, re-calibration should be performed within 12 months from the date of purchase, however, no later than 24 months from the date of purchase.

#### **ATTENTION !**

**The person performing the measurements should be absolutely sure about the efficiency of the device being used. Measurements made with an inefficient meter can contribute to an incorrect assessment of the effectiveness of health protection and even human life.**

## NOTES















## NOTES

## NOTES

## WARNINGS AND GENERAL INFORMATION DISPLAYED BY THE METER

### NOTE!

MZC-304 meter is designed for operation at the 220V, 230V and 240V rated phase-to-neutral voltage and the 380V, 400V and 415V phase-to-phase voltage. Connecting the voltage higher than allowed between any measuring terminals may damage the meter and be a hazard to the user.

	The meter is ready for measurement.
	Voltage on terminals <b>L</b> and <b>N</b> is outside the measurable range.
	Voltage on terminals <b>L</b> and <b>PE</b> is outside the measurable range.
	Error during the measurement.
	Error during the measurement: voltage dip after the measurement.
	Short circuit malfunction.
	Conductor <b>N</b> is not connected.
	Huge noise in the system during the measurement. The measurement result may be affected by a large, unspecified error.
	The temperature inside the meter has risen above the limit. The measurement is blocked.
	The <b>L</b> and <b>N</b> conductors have been switched (voltage between terminals <b>PE</b> and <b>N</b> ).
	The tested facility is live. The measurement is blocked. <b>Immediately disconnect the meter from the facility (both conductors).</b>
	Indication of battery level: Batteries charged Batteries low Batteries fully discharged. Replace or recharge the batteries.



**SONEL S.A.**  
**Wokulskiego 11**  
**58-100 Swidnica**  
**Poland**



**+48 74 858 38 60**  
**+48 74 858 38 00**  
**fax +48 74 858 38 09**

**e-mail: [export@sonel.pl](mailto:export@sonel.pl)**  
**[www.sonel.pl](http://www.sonel.pl)**