

293387-2 ✓ ACTIVE

NECTOR | NECTOR S

TE Internal #: 293387-2

NECTOR S, Plug & Socket Lighting Connector Accessories, Wire-to-Wire, 2 Position, 3.6mm Centerline, Wire & Cable, Operating Voltage 125 VAC

[View on TE.com >](#)



Connectors > Lighting Connectors > Plug & Socket Connector Accessories



Connector System: **Wire-to-Wire**

Number of Positions: **2**

Centerline (Pitch): **3.6 mm**

Sealable: **No**

Connector & Contact Terminates To: **Wire & Cable**

Features

Product Type Features

Product Type	Accessory
Connector System	Wire-to-Wire
Sealable	No
Connector & Contact Terminates To	Wire & Cable

Configuration Features

Keying Arrangement	HV-4
Number of Positions	2

Electrical Characteristics

Operating Voltage	125 VAC
-------------------	---------

Contact Features

Contact Current Rating (Max)	6 A
------------------------------	-----

Mechanical Attachment

Connector Mounting Type	Cable Mount (Free-Hanging)
-------------------------	----------------------------



Housing Features

Housing Color	White
Centerline (Pitch)	3.6 mm

Operation/Application

Circuit Application	Power
---------------------	-------

Product Compliance

For compliance documentation, visit the product page on [TE.com](https://www.te.com)>

EU RoHS Directive 2011/65/EU	Compliant
EU ELV Directive 2000/53/EC	Compliant
China RoHS 2 Directive MIIT Order No 32, 2016	No Restricted Materials Above Threshold
EU REACH Regulation (EC) No. 1907/2006	Current ECHA Candidate List: JAN 2021 (211) Candidate List Declared Against: JUN 2020 (209) SVHC > Threshold: Not Yet Reviewed
Halogen Content	Low Halogen - Br, Cl, F, I < 900 ppm per homogenous material. Also BFR/CFR/PVC Free
Solder Process Capability	Not reviewed for solder process capability

Product Compliance Disclaimer

This information is provided based on reasonable inquiry of our suppliers and represents our current actual knowledge based on the information they provided. This information is subject to change. The part numbers that TE has identified as EU RoHS compliant have a maximum concentration of 0.1% by weight in homogenous materials for lead, hexavalent chromium, mercury, PBB, PBDE, DBP, BBP, DEHP, DIBP, and 0.01% for cadmium, or qualify for an exemption to these limits as defined in the Annexes of Directive 2011/65/EU (RoHS2). Finished electrical and electronic equipment products will be CE marked as required by Directive 2011/65/EU. Components may not be CE marked. Additionally, the part numbers that TE has identified as EU ELV compliant have a maximum concentration of 0.1% by weight in homogenous materials for lead, hexavalent chromium, and mercury, and 0.01% for cadmium, or qualify for an exemption to these limits as defined in the Annexes of Directive 2000/53/EC (ELV). Regarding the REACH Regulation, the information TE provides on SVHC in articles for this part number is based on the latest European Chemicals Agency (ECHA) 'Guidance on requirements for substances in articles' posted at this URL: <https://echa.europa.eu/guidance-documents/guidance-on-reach>

Compatible Parts



TE Part # 293389-1
MICRO QUADLOK SYSTEM PIN CONTACT



TE Part # 293654-3
NECTOR S-Line PCB Assy 90deg. rec.



TE Part # 293655-3
NECTOR S PCB PLUG STR HV-4 WHITE



TE Part # 293387-4
NECTOR S OUTLET LV-2 WHITE

Also in the Series | NECTOR S



Insertion & Extraction Tools(3)



Lighting Cable Assemblies(1)



Plug & Socket Lighting Connector Accessories(57)



Plug & Socket Lighting Connectors(54)

Customers Also Bought



TE Part #103361-4
06 MODII HDR SRRA SHRD .100CL



TE Part #1-794609-0
PIN CONT 26-30 TIN PLATE STRIP



TE Part #1-456403-5
CRIMPER WIRE .062 F



TE Part #1740259-1
NECTOR S PLUG HV-1 WHITE



TE Part #1-2316102-2
12P,2MM,REC,HSG,SR,CRIMP,PLAIN,BOX

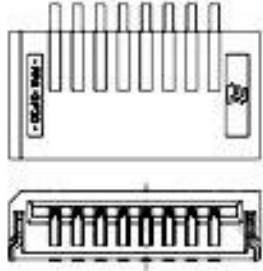

TE Part #1735360-8
1mm FFC SMT H BOTTOM CONTACT ASSY, 8P

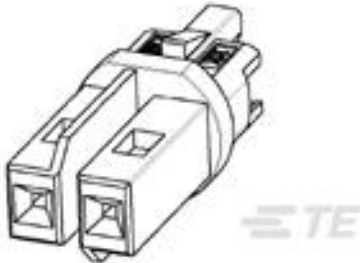

TE Part #1740259-5
NECTOR S PLUG HV-2 RED



TE Part #ZPF000000000008615
983-6S 14-15 SN-L



TE Part #1740260-2
NECTOR S TUBE BLACK



TE Part #1366402-1
SAHT ECONOMY POWER 22-18 ASSY



Documents

Product Drawings

NECTOR S OUTLET HV-4 WHITE

English

CAD Files

3D PDF

3D

Customer View Model

[ENG_CVM_CVM_293387-2_C.2d_dxf.zip](#)

English

Customer View Model

[ENG_CVM_CVM_293387-2_C.3d_igs.zip](#)

English

Customer View Model

[ENG_CVM_CVM_293387-2_C.3d_stp.zip](#)

English

By downloading the CAD file I accept and agree to the [Terms and Conditions](#) of use.

Datasheets & Catalog Pages

NECTOR_S_LINE_CONNECTOR_BROCHURE

English

Agency Approvals

UL Report

English