

# D3D

## Miniature Door Switch

### 9mm long stroke with its unique mechanism (plunger model)

- Choose from plunger or lever as the actuator type.
- Crimp-type connector offers an easy wiring work and efficiency.
- Snap-fit attachment for easy installation.
- Providing two colors, black and white.
- Mainly used for refrigerators.

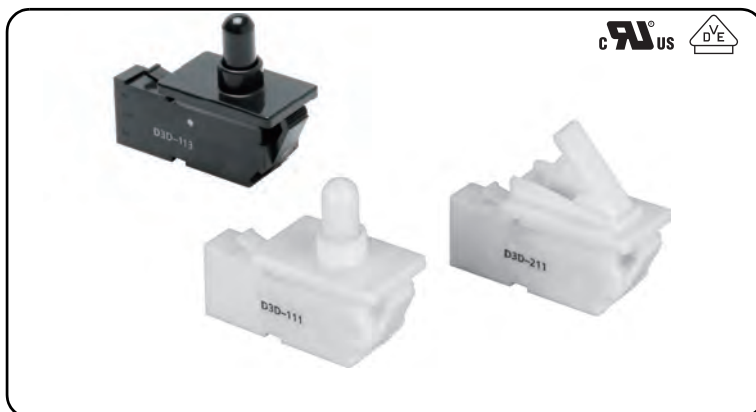

RoHS Compliant

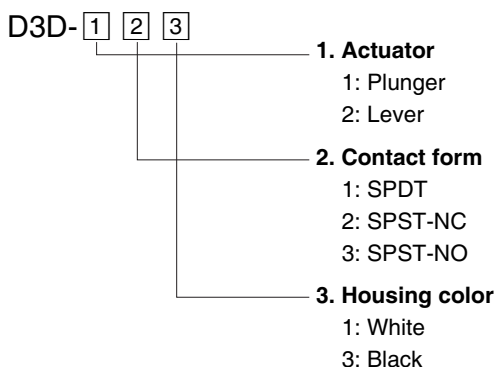

### Model Number Legend



### List of Models

Actuator	Housing color	Contact form		
		SPDT	SPST-NC	SPST-NO
Plunger 	White	D3D-111	D3D-121	D3D-131
	Black	D3D-113	D3D-123	D3D-133
Lever 	White	D3D-211	D3D-221	D3D-231
	Black	D3D-213	D3D-223	D3D-233

### Contact Form

#### ● SPDT

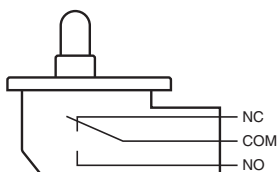

#### ● SPST-NC

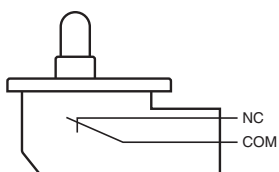

#### ● SPST-NO

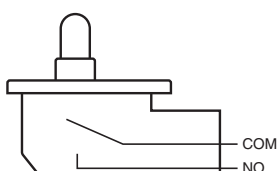

### Contact Specifications

Item	Model	D3D
Contact	Specification	Crossbar
	Material	Gold alloy
Minimum applicable load (reference value) *		5 VDC 1 mA

\* Please refer to "●Using Micro Loads" in "Precautions" for more information on the minimum applicable load.

### Ratings

Rated voltage	Resistive load
125 VAC	1 A
250 VAC	0.5 A

Note. The above rating values apply under the following test conditions.

- (1) Ambient temperature: 20±2°C
- (2) Ambient humidity: 65±5%
- (3) Operating frequency: 30 operations/min

### Approved Safety Standards

#### UL (UL61058-1)/cUL (CSA C22.2 No.61058-1)

Rated voltage	Model	D3D
	Item	Resistive load
125 VAC		1 A
250 VAC		0.5 A

#### VDE (EN61058-1)

Rated voltage	Model	D3D
125 VAC		1 A
250 VAC		0.5 A

Testing conditions: 5E4 (50,000 operations) T55 (0°C to 55°C)

## Characteristics

Permissible operating speed		7.5 mm to 500 mm/s
Permissible operating frequency	Mechanical	120 operations/min
	Electrical	20 operations/min
Insulation resistance		100 MΩ min. (at 500 VDC with insulation tester)
Contact resistance (initial value)		100 mΩ max.
Dielectric strength	Between terminals of the same polarity	1,000 VAC 50/60 Hz 1 min
	Between current-carrying metal parts and ground	1,500 VAC 50/60Hz 1 min
	Between each terminals and non-current-carrying metal parts	1,500 VAC 50/60Hz 1 min
Vibration resistance *1	Malfunction	10 to 55Hz, 1.5 mm double amplitude
Shock resistance *1	Durability	490 m/s <sup>2</sup> {approx. 49G} max.
	Malfunction	300 m/s <sup>2</sup> {approx. 30G} max.
Durability *2	Mechanical	300,000 operations min. (60 operations/min)
	Electrical	50,000 operations min. (20 operations/min)
Degree of protection		IEC IP00
Degree of protection against electric shock		Class I
Proof tracking index (PTI)		250
Ambient operating temperature		-30°C to +60°C (at ambient humidity 60% max.) (with no icing or condensation)
Ambient operating humidity		85% max. (for +5 to +35°C)
Weight		Approx. 4g

Note. The given values are initial values.

\*1. Close or open circuit of the contact is 1 ms max.

\*2. For testing conditions, consult your OMRON sales representative.

## Mounting Holes (Unit: mm)

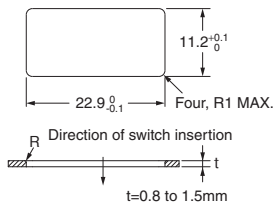

## Dimensions (Unit: mm) and Operating Characteristics

The illustrations are for models with white housing as a representative. The □ is replaced with the code for the housing color that you need. See the "List of Models" for available combinations of models.

### ●Plunger Models

- D3D-11□
- D3D-12□
- D3D-13□

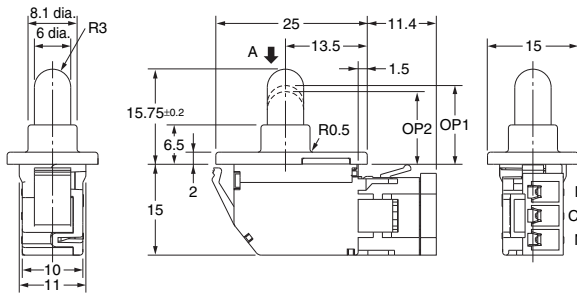

		Type	Plunger model		
		Model	D3D-11□	D3D-12□	D3D-13□
Operating Characteristics	Operating Force	OF Max.	2.0 N {204 gf}		
	Total Travel Force	TTF Max.	3.5 N {357 gf}		
	Total Travel	TT	9.0 mm (reference value)		
Operating Position	OP	Min.	OP1 (NC-OFF) 13 mm	13 mm (NC-OFF)	12 mm (NO-ON)
			OP2 (NO-ON) 12 mm		

### ●Lever Models

- D3D-21□
- D3D-22□
- D3D-23□

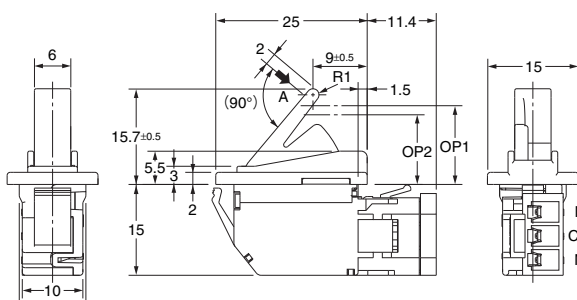

		Type	Lever model		
		Model	D3D-21□	D3D-22□	D3D-23□
Operating Characteristics	Operating Force	OF Max.	2.0 N {204 gf}		
	Total Travel Force	TTF Max.	2.5 N {245 gf}		
	Total Travel	TT	9.7 mm (reference value)		
Operating Position	OP	Min.	OP1 (NC-OFF) 13 mm	13 mm (NC-OFF)	11.5 mm (NO-ON)
			OP2 (NO-ON) 11.5 mm		

Note 1. Unless otherwise specified, a tolerance of ±0.4 mm applies to all dimensions.

Note 2. The operating characteristics are for operation in the A direction (↓).

## Precautions

★Please refer to "Common Precautions" for correct use.

### Correct Use

#### ●Mounting

This product does not have a waterproof or drip-proof construction. Ensure that water does not enter the interior of the Switch.

In particular, do not use the Switch in locations where water may be spilt or flow over the Switch. Doing so may result in deterioration of the insulation.

#### ●Operating Stroke

In order to ensure stable contact force for NO contacts, set the total stroke at least 5 mm.

#### ●Wiring

Do not use the Switch with Connector mounted and weight load applied to the Connector and lead wire, otherwise it may rattle or may result in connection failure.

#### ●Using Micro Loads

Even when using the Switch within the operating range, if there are inrush currents or surges, it may decrease the durability of the Switch. If necessary, insert a contact protection circuit.

## Connector

- The terminals connect to JST's HL Connector.  
Contact: SSF-21T-P1.4  
Housing: HLP-03V
- OMRON does not sell the HL Connector.
- Contact JST Mfg. for more information on the connectors.

#### J.S.T. Manufacturing Co.,Ltd.

[http://www.jst-mfg.com/index\\_e.php](http://www.jst-mfg.com/index_e.php)

Please check each region's Terms & Conditions by region website.

## OMRON Corporation

Electronic and Mechanical Components Company

### Regional Contact

#### Americas

<https://www.components.omron.com/>

#### Asia-Pacific

<https://ecb.omron.com.sg/>

#### Korea

<https://www.omron-ecb.co.kr/>

#### Europe

<http://components.omron.eu/>

#### China

<https://www.ecb.omron.com.cn/>

#### Japan

<https://www.omron.co.jp/ecb/>