

M12 MALE 0° / MSUD VALVE PLUG FORM A 18MM

PUR 5X0.34 black 1m

Form A (18 mm) – M12, male straight
for pressure switches
LED (red/green)
5-pole

Further cable lengths on request. Plastic housings with good resistance against chemicals and oils. The resistance to aggressive media should be individually tested for your application. Further details on request.

[Link to Product](#)

Illustration

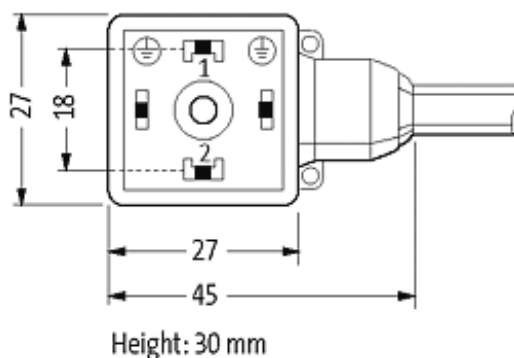
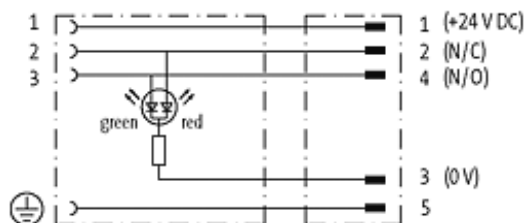

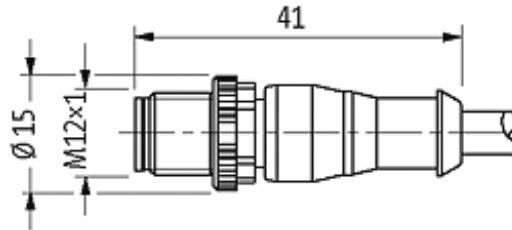

Product may differ from Image

Approvals



Technical Data

Operating voltage	24 V DC $\pm 25\%$
Operating current per contact	max. 4 A
Locking of ports	M3/M12 \times 1 mm (recommended torque 0.4/0.6 Nm)
Protection	IP67 inserted and tightened (EN 60529)
Housing	Black plastic (gray on request)

Cables

Cable number	625
No./diameter of wires	5 \times 0.34 mm ²
Wire isolation	PVC (br, wh, bl, bk, gnye)
C-track properties	2 Mio.
Jacket Color	black
Shore hardness outer jacket	85 \pm 5A
Material (jacket)	PUR/PVC (UL/CSA)
Outer diameter	approx. 5.9 mm
Bend radius (fixed)	10 \times outer \varnothing
Bend radius (moving)	15 \times outer \varnothing
Temperature range (fixed)	-30...+80 °C
Temperature range (mobile)	-5...+80 °C

General data

Temperature range	-25...+85 °C, depending on cable quality
-------------------	--

Commercial data

country of origin	CZ
customs tariff number	85444290
minimum order quantity	1