

AHV SERIES

THREE PHASE VERY HIGH PERFORMANCE EMI FILTER

Dual stage delta configuration

INTRODUCTION

Chassis for motor drive applications requiring compact space and convenient installation with superior performance at significant interference levels

APPLICATIONS

- IT power distribution network
- Three phase drives
- Renewable energy systems
- Process automation equipments
- Energy conversion devices

FEATURES

- Superior performance
- Compact
- Low leakage current
- Chassis mounting

APPROVALS & COMPLIANCE

- UL recognized as per UL 60939-3 and CSA22.2 No 8

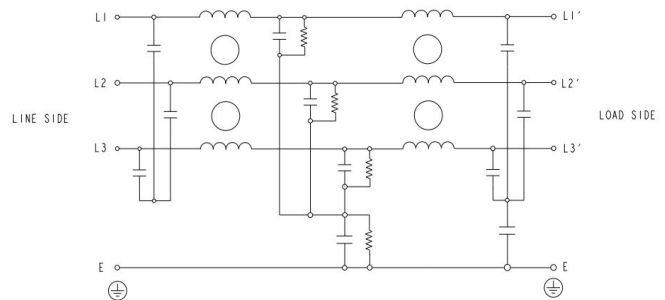
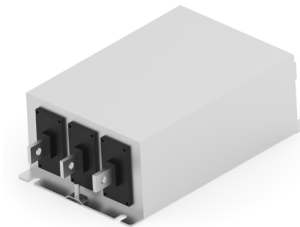

TYPICAL CIRCUIT DIAGRAM

Specifications

Electrical Characteristics	
Agency Rated Voltage	Line to Line: 760/750VAC
Current Ratings	7A to 1000A @ 40°C
Operating Frequency	50/60Hz
High Potential Test Voltage	Line to Ground: 3535VDC for 1 Minute
	Line to Line: 3268VDC for 1 Minute
Overload Capability	135% of Rated current for 15 minutes

AHV Series

Dual Stage Delta Configuration

Functional Characteristics	
Operating Temperature Range	-25°C to +85°C
Climatic Category	25/85/21
Termination	Quick Connect (7A to 100A) Bolt & Nut (125A to 250A) Busbar (300A to 1000A)
Flammability Corresponding to	UL 94 V-0

Reference Standards	
Design Corresponding to	UL 60939-3 and CSA22.2 No 8

Selection Table - Standard Version

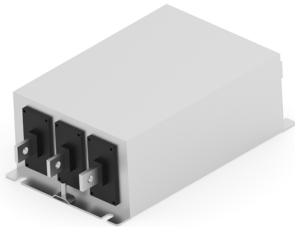

TE Ordering Number	Catalog Number	Rated Current @40°C	Rated Voltage @40°C	Leakage Current (mA)	Weight (Kgs)	Termination Type
2405082-1	6 AHV D FP	6A	760	4mA	4	1
2405082-2	10 AHV D FP	10A	760	4mA	4	1
2405082-3	16 AHV D FP	16A	760	4mA	4	1
2405082-4	20 AHV D FP	20A	760	4mA	4	1
2405082-5	25 AHV D FP	25A	760	4mA	5	1
2405082-6	30 AHV D FP	30A	760	4mA	5	1
2405082-7	40 AHV D FP	40A	760	4mA	5	1
2405082-8	50 AHV D FP	50A	760	5mA	6	1
2405082-9	63 AHV D FP	63A	760	6mA	6	1
1-2405082-0	75 AHV D FP	75A	760	6mA	6	1
1-2405082-1	80 AHV D FP	80A	760	6mA	8	1
1-2405082-2	90 AHV D FP	90A	760	6mA	8	2
1-2405082-3	100 AHV D FP	100A	760	6mA	8	2
1-2405082-4	125 AHV D FP	125A	760	6mA	11	M10 STUD
1-2405082-5	150 AHV D FP	150A	760	6mA	12	M12 STUD
1-2405082-6	180 AHV D FP	180A	760	6mA	12	M12 STUD

AHV Series

Dual Stage Delta Configuration

TE Ordering Number	Catalog Number	Rated Current @40°C	Rated Voltage @40°C	Leakage Current (mA)	Weight (Kgs)	Termination Type
1-2405082-7	250 AHV D FP	250A	760	6mA	12	M12 STUD
1-2405082-8	320 AHV D FP	320A	760	6mA	18	BUSBAR 6 x 25mm
1-2405082-9	400 AHV D FP	400A	760	6mA	18	BUSBAR 6 x 25mm
2-2405082-0	500 AHV D FP	500A	760	6mA	21	BUSBAR 10 x 25mm
2-2405082-1	600 AHV D FP	600A	760	6mA	21	BUSBAR 10 x 25mm
2-2405082-2	700 AHV D FP	700A	760	6mA	26	BUSBAR 10 x 40mm
2-2405082-3	800 AHV D FP	800A	760	6mA	26	BUSBAR 10 x 40mm
2-2405082-4	1000 AHV D FP	1000A	760	6mA	26	BUSBAR 10 x 40mm

Termination Type: Connectors Cross Section

	1	2	3	4
Range; Flexible (mm ²)	0.5 - 16	10 - 25	16 - 50	35 - 95

Insertion Loss (Typical) – Measured in Closed 50Ω System

		Common Mode 50Ω/50Ω								
		Frequency in MHz								
		0.01	0.05	0.15	0.5	1	3	5	10	30
Current Rating	6A	15	35	65	85	75	54	46	32	22
	10A	15.3	32.7	65.5	85.5	78.4	64.1	56.1	45.1	34.4
	16A	10	30	50	80	75	65	52	42	34
	20A	5	20	45	75	78	63	56	40	28
	25A	3.98	12.1	39.2	70.5	74	57.3	49.5	37.7	31.2
	30A	3.24	12.1	36.3	61.8	73.3	62.4	55.3	45.9	35.2
	40A	3.5	12.6	34	58	71	57.8	50.21	38	29.7
	50A	5	12	35	62	70	60	50	45	32
	63A	4	11	32	65	68	55	45	32	22
	75A	3	9.5	28	60	57	51	41	35	20

AHV Series

Dual Stage Delta Configuration

		Common Mode 50Ω/50Ω								
		Frequency in MHz								
		0.01	0.05	0.15	0.5	1	3	5	10	30
Current Rating	80A	2.75	8	30	57	60	48	38	31	22
	90A	2.1	6	28	57	56	45	36	34	24
	100A	1.85	3.5	12	38	48	41	32	30	21
	125A	0.225	3.01	7.7	28.6	42.3	55.6	50.9	42.6	24.4
	150A	0.185	2.2	7	25	38	41	38	34	26
	180A	0.145	1.75	6.5	35	39	42	36	30	20
	250A	0.155	1.28	4.89	32.6	42.4	40.9	35.9	29	17
	320A	0.088	0.144	1.6	16.9	24.7	55.9	46.7	27	15.6
	400A	0.088	0.144	1.6	16.9	24.7	55.9	46.7	27	15.6
	500A	0.028	0.262	1.97	11.1	21.6	38.6	35	28.3	17.6
	600A	0.028	0.262	1.97	11.1	21.6	38.6	35	28.3	17.6
	700A	0.094	0.176	1.29	12.9	20.7	50.8	43.3	25	14.7
	800A	0.094	0.176	1.29	12.9	20.7	50.8	43.3	25	14.7
1000A	0.094	0.176	1.29	12.9	20.7	50.8	43.3	25	14.7	

		Differential Mode 50Ω/50Ω								
		Frequency in MHz								
		0.01	0.05	0.15	0.5	1	3	5	10	30
Current Rating	6A	19	46	75	75	78	80	78	75	55
	10A	18.3	61.8	72.2	72.9	75.4	80.6	81.8	82.8	60.3
	16A	18	25	68	72	70	74	66	54	52
	20A	20	25	62	68	66	57	54	52	43
	25A	20.2	23.7	59.3	63.5	64.6	64.3	64.4	61	58.2
	30A	20.6	24.1	73.9	85.1	99.1	82	79.7	79.4	69.6
	40A	38.5	25.8	55.6	57.8	59.4	58.6	58.2	54.2	49.9
	50A	20	25	70	80	75	70	65	45	40
	63A	22	25	70	75	65	62	59	53	42
	75A	20	22	67	70	65	61	54	51	36
	80A	18	33	52	68	64	58	51	40	26
	90A	17	33	49	68	62	56	49	38	21

AHV Series

Dual Stage Delta Configuration

		Differential Mode 50Ω/50Ω								
		Frequency in MHz								
		0.01	0.05	0.15	0.5	1	3	5	10	30
Current Rating	100A	16	35	50	65	62	54	42	36	17
	125A	29	37.6	67.9	71.4	67.1	59.8	57.2	54.2	44
	150A	30	42	63	73	66	64	65	50	40
	180A	26	38	60	68	64	60	55	48	40
	250A	28.9	38.2	60.8	65.9	61.4	54.3	52	49.4	41.5
	320A	29.5	41.7	47.8	61.3	50.5	41	37.9	34.6	25.9
	400A	29.5	41.7	47.8	61.3	50.5	41	37.9	34.6	25.9
	500A	29.6	42.5	55	53.1	46.4	37.4	36.3	32.6	24.9
	600A	29.6	42.5	55	53.1	46.4	37.4	36.3	32.6	24.9
	700A	31.3	43.7	56.7	54.4	46.4	36.7	35	31.5	23
	800A	31.3	43.7	56.7	54.4	46.4	36.7	35	31.5	23
	1000A	31.3	43.7	56.7	54.4	46.4	36.7	35	31.5	23

Mechanical Diagram

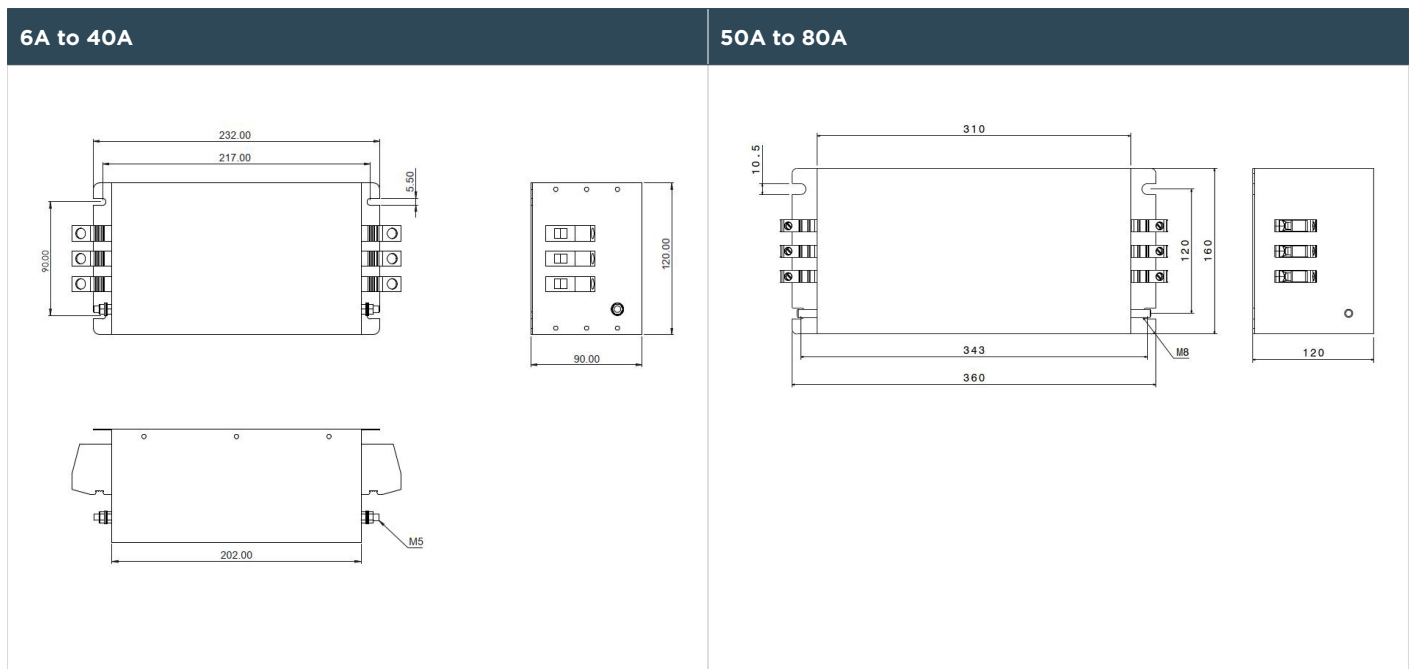

AHV Series

Dual Stage Delta Configuration

90A

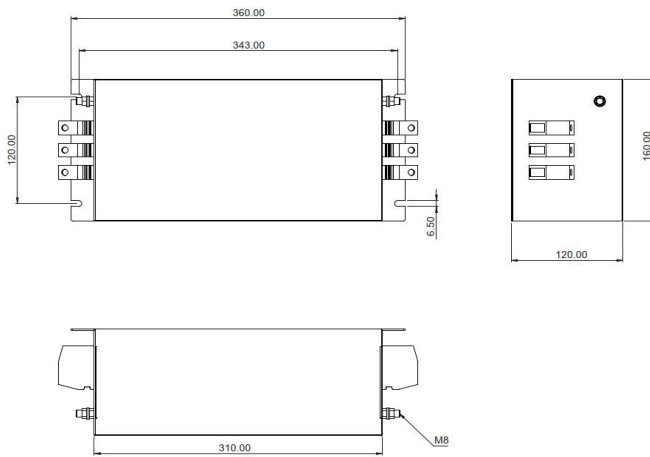

100A

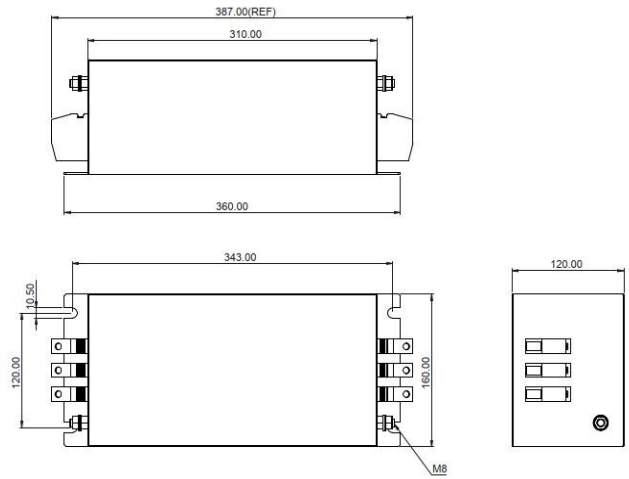

125A

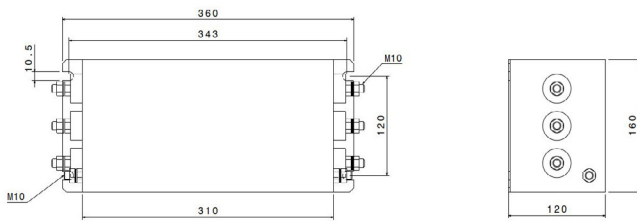

150A to 250A

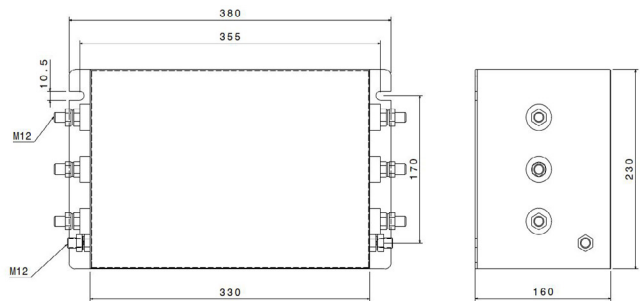

320A to 400A

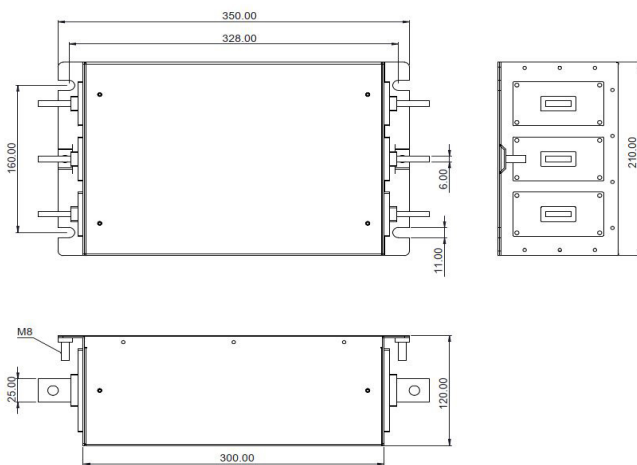

500A to 600A

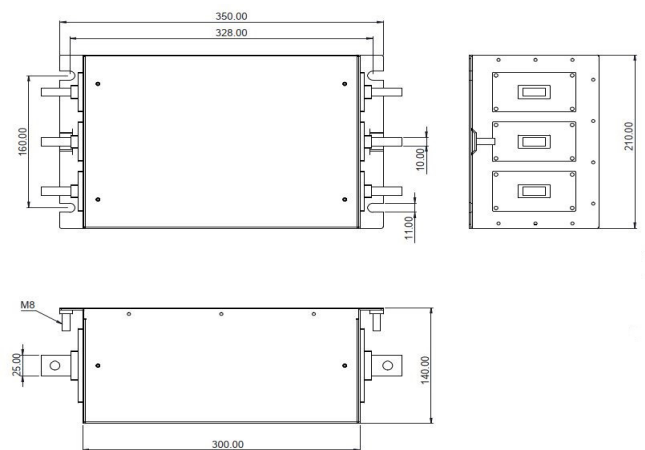

700A to 1000A

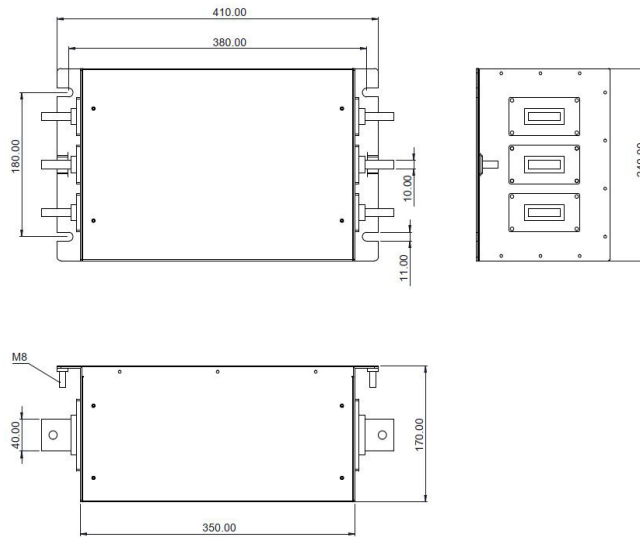

HOW TO ORDER

Part Number
10 - AHV - D FP

Current Rating

10

Series Type

AHV

Filter Stage

D

Dual

Fully Potted

FP

[te.com](https://www.te.com)

©2022 TE Connectivity. All Rights Reserved.

TE Connectivity, TE Connectivity (logo) and Every Connection Counts are trademarks. All other logos, products and/or company names referred to herein might be trademarks of their respective owners.

The information given herein, including drawings, illustrations and schematics which are intended for illustration purposes only, is believed to be reliable. However, TE Connectivity makes no warranties as to its accuracy or completeness and disclaims any liability in connection with its use. TE Connectivity's obligations shall only be as set forth in TE Connectivity's Standard Terms and Conditions of Sale for this product and in no case will TE Connectivity be liable for any incidental, indirect or consequential damages arising out of the sale, resale, use or misuse of the product. Users of TE Connectivity products should make their own evaluation to determine the suitability of each such product for the specific application.

08/22 TJ