



FUSELESS LOAD FEEDER REVERSING
OPERATION, 400 V AC, SZ. S00 0.55...0.80A 3 KW, 24
V DC SPRING-LOADED TERMINAL FOR BUSBAR
SYSTEMS 60 MM (ALSO FULFILLS COORD. TYPE 1)
TYPE OF COORD. 2, IQ = 150 KA 1NC (CONTACTOR)
ADAPTER LENGTH 200 MM 1NC (CONTACTOR)
ADAPTER LENGTH 200MM

Figure similar

product brand name		SIRIUS
Product designation		non-fused load feeders 3RA2
Manufacturer article number		
<ul style="list-style-type: none"> • of the supplied contactor • of the supplied circuit-breakers • of the supplied RS assembly kit • of the supplied busbar adapter • of the supplied link module 		3RT2015-2BB42 3RV2011-0HA20 8US1250-5AS10 8US1251-5DS11 3RA2911-2AA00

General technical data:

Insulation voltage		
<ul style="list-style-type: none"> • with degree of pollution 3 Rated value 	V	690
Shock resistance		
<ul style="list-style-type: none"> • acc. to IEC 60068-2-27 		6g / 11 ms
Surge voltage resistance Rated value	kV	6
Type of assignment		2
Protection class IP		
<ul style="list-style-type: none"> • on the front 		IP20

Main circuit:

Number of poles for main current circuit		3
Adjustable response value current of the current-dependent overload release	A	0.55 ... 0.8
Operating voltage		
<ul style="list-style-type: none"> • Rated value • at AC-3 Rated value maximum 	V	690
	V	690
Operating frequency Rated value	Hz	50 ... 60

Operating current		
<ul style="list-style-type: none"> • at AC-3 <ul style="list-style-type: none"> — at 400 V Rated value 	A	0.6
Operating power		
<ul style="list-style-type: none"> • at AC-3 <ul style="list-style-type: none"> — at 400 V Rated value — at 500 V Rated value — at 690 V Rated value 	W	180
	W	180
	W	250

Control circuit/ Control:

Control supply voltage for DC		
<ul style="list-style-type: none"> • Rated value 	V	24
Holding power of the magnet coil for DC	W	4

Auxiliary circuit:

Product expansion Auxiliary switch		Yes
---	--	-----

Protective and monitoring functions:

Trip class		CLASS 10
Design of the overload circuit breaker		thermal (bimetallic)

UL/CSA ratings:

Full-load current (FLA) for three-phase AC motor		
<ul style="list-style-type: none"> • at 480 V Rated value 	A	0.8

Short-circuit:

Product function Short circuit protection		Yes
Design of the short-circuit trip		magnetic
Conditional short-circuit current (I_q)		
<ul style="list-style-type: none"> • at 690 V acc. to IEC 60947-4-1 Rated value • at 400 V acc. to IEC 60947-4-1 Rated value • at 500 V acc. to IEC 60947-4-1 Rated value 	A	100 000
	A	153 000
	A	100 000

Installation/ mounting/ dimensions:

mounting position		vertical
Mounting type		for snapping onto 60 mm busbar systems
Height	mm	260
Width	mm	90
Depth	mm	154.9
Required spacing		
<ul style="list-style-type: none"> • for grounded parts <ul style="list-style-type: none"> — forwards — Backwards — upwards — at the side — downwards 	mm	0
	mm	0
	mm	20
	mm	9
	mm	10

• for live parts		
— forwards	mm	0
— Backwards	mm	0
— upwards	mm	20
— downwards	mm	10
— at the side	mm	9

Connections/ Terminals:

Type of electrical connection

- for main current circuit
- spring-loaded terminals

Safety related data:

B10 value with high demand rate acc. to SN 31920		1 000 000
Proportion of dangerous failures		
• with high demand rate acc. to SN 31920	%	73
Protection against electrical shock		finger-safe





Mechanical data:

Size of the circuit-breaker		S00
Size of load feeder		S00

Ambient conditions:

Ambient temperature		
• during operation	°C	-20 ... +60
• during storage	°C	-50 ... +80
• during transport	°C	-50 ... +80

Certificates/ approvals:

General Product Approval	For use in hazardous locations	Declaration of Conformity	other
 CSA	 UL		 ATEX
		 EG-Konf.	Environmental Confirmations

other

- [Declaration of Conformity](#)
- [other](#)

Further information

Information- and Downloadcenter (Catalogs, Brochures,...)
<http://www.siemens.com/industrial-controls/catalogs>

Industry Mall (Online ordering system)

<http://www.siemens.com/industrymall>

Cax online generator

<http://support.automation.siemens.com/WW/CAXorder/default.aspx?lang=en&mfb=3RA22100HS152BB4>

Service&Support (Manuals, Certificates, Characteristics, FAQs,...)

<http://support.automation.siemens.com/WW/view/en/3RA22100HS152BB4/all>

Image database (product images, 2D dimension drawings, 3D models, device circuit diagrams, EPLAN macros, ...)

http://www.automation.siemens.com/bilddb/cax_de.aspx?mfb=3RA22100HS152BB4&lang=en

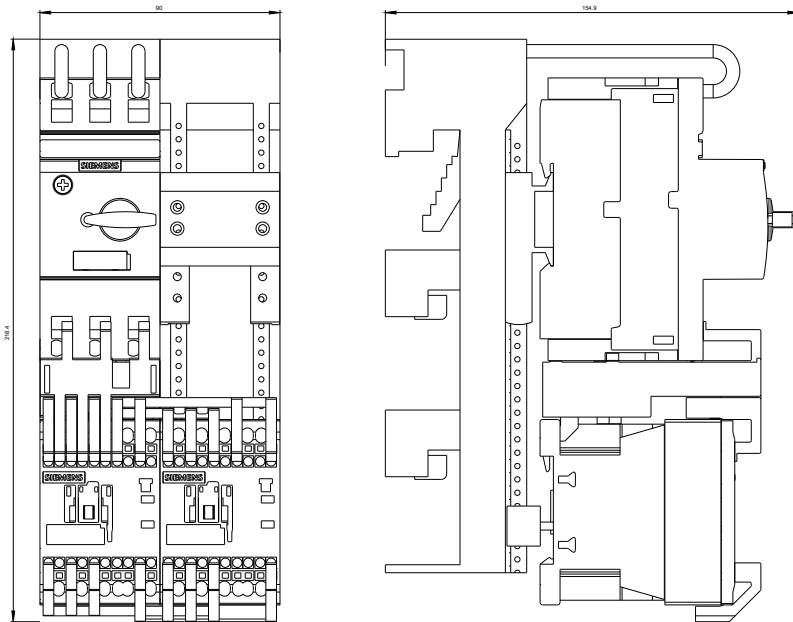

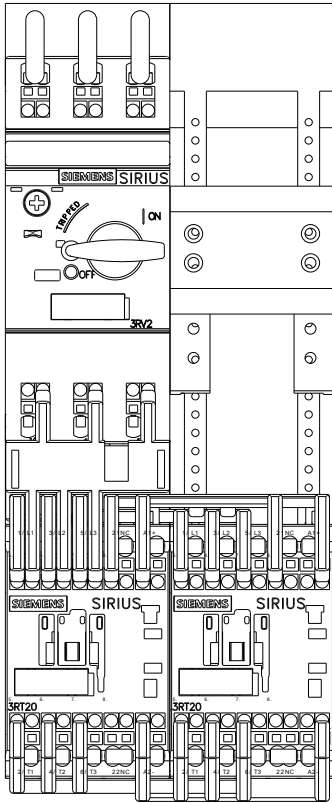

REBRÄUERBEREITUNGSGRUNDZUGSCHRIFT

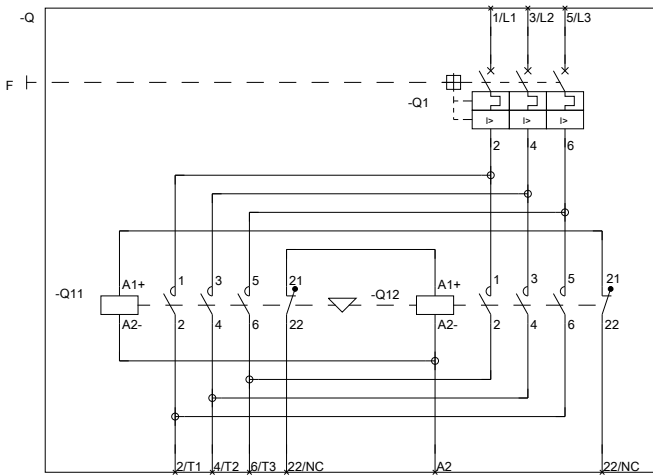

BRÄUERBEREITUNGSGRUNDZUGSCHRIFT

last modified:

11.03.2015