



Index

Series Swisstac

Description	Page 583
Product Assembly	Page 584
Mounting Instruction	Page 585
Product Range	
- pushbuttons for standard mounting	Page 591
- pushbuttons for flush mounting	Page 608
- accessories / spare parts	Page 622
Technical Data	Page 638
Drawing / Dimension / Layouts	Page 642
Circuit Drawing	Page 657
Marking	Page 667

SWISSTAC - Three crucial advantages!

Easy storage in minimum space
Every SWISSTAC switch can be altered very simply any number of times, and afterwards added to, modified or adapted. This highly modular concept means that only a few subassemblies reducing storage costs.

All connections on one plane

All the terminals are arranged at the same level, are clearly laid out and fully accessible even when in close-packed arrays. Three colours provide optical help to make connections easier.

Ideal for switch interlock systems

SWISSTAC switches can be mechanically combined in many ways to form switch interlock systems and in fact in rows of up to 20 switches. This means that complicated protection and relay interlocks are unnecessary. Individual and irregular spacings between the switches of an array are no problem either.

CE

Our products are marked with the internationally approved CE low-voltage safety standard.

General information

Swisstac, a modularly constructed control switch system, offers the user a wide range of products: buzzers, illuminated pushbuttons and pushbuttons, indicators, emergency stop switches, push-pull illuminated switches, keylock switches and selector switches, as well as switch interlock systems in the front-facing protection classes IP 40 and IP 65.

The front dimensions of the switch units are: 18 mm dia., 18 x 18 mm, 24 mm dia., 24 x 24 mm. For flush mounting, dimensions 25 mm dia., 24 x 24 mm, 24 x 30 mm are also available.

Construction

SWISSTAC switches are of modular construction and are divided into the following three groups:

- Front section: Man/switch interface and status indicator two-part lens for engraving, film insert or printing
- Intermediate section: Latching/ pulse facility, lamp holder, latch function
- Intermediate section with switching mechanism and lamp holder, which is available in two versions: T: 5.5 max., 1.2 W and midget grooved T 1 3/4 max.

1.2 W.

- Terminal block: up to a max. of five switching elements can be joined together in one switch terminal block. Are supplied mounted serially on intermediate sections.

Can be disassembled easily for wiring.

Marking

Engraved, printed film inlay see under 'Marking' page 667.

Illumination

Perfect illumination of the lenses supplied in various colours is guaranteed by the incandescent lamps midget grooved T 1 3/4 and T 5.5 (6-60V9).

Where supply voltages are over 60 V, a voltage-reduction element (ext. protective series resistor or capacitor) must be used. Because of high surface temperature, the protective series resistor may not be soldered direct onto the connections of the pushbuttons.

Multi-LED midget grooved T 1 3/4 and T 5.5 (6, 12, 24, 48 V) are available in the colours red, yellow and green.

Switch position indicator

When the pushbutton with latch function is operated, the lens latches in mechanically. The position of the lens makes the switch position evident at all the times.

Keylock switches

Standard lock

1 Standard number is B2 300. We supply B2 300 without specifications of the lock numbers. Four further standard locks are B2 301 - B2 304. This additional designation should be quoted when ordering. A further 95 locks are available in or without passepartout version on request. 2 keys are supplied per keylock switch.

Spare keys for a standard lock can be ordered under Type no. 240-2001-00 (please quote lock number). Example: 240-200-00 B2 300.

Emergency stop switch with key to unlock

Standard lock is B2 390. Four further standard locks are B2 391 - B2-394. When ordering this additional designation should be quoted. Spare keys for standard lock can be ordered under Type no. 240-3001-00 (please quote lock). Example: 240-3001-00 B2 390.

Two keys are supplied per emergency stop switch.

Emergency Stop Switch, foolproof with key to unlock

Kaba safety switch. Standard lock number is 1001. Spare keys can be ordered under Type no. 240.4001-00 1001.

2 keys are supplied per emergency stop switches.

All measurements in mm

Technical specifications subject to modification.

illuminated-/pushbutton



- 1 lens
- 2 front bezel
- 3 fixing nut
- 4 spring with pin for changing from maintained to momentary
- 5 intermediate section
- 6 holder for switching element
- 7 switching element block
- 8 switching element

pushbutton-/illuminated pushbutton for flush mounting



- 1 lens
- 2 front bezel
- 3 front bezel set f. fl. mounting
- 4 front panel
- 5 fixing nut
- 6 spring with pin f. changing from main to mom
- 7 intermediate section
- 8 holder f. switching element
- 9 switching element block
- 10 switching element

illuminated-/pushbutton 35mm

The switch is mounted in a fascia or control panel in three steps:

1. Detach terminal block as in drawing, remove fixing nut
2. Insert switch from the front in fascia/control panel
3. Reassemble the switch in the reverse order

To detach terminal block

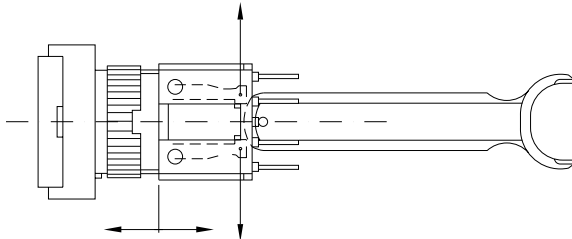

Note: Type-identification on legs of actuator

illuminated-/pushbutton 55 - 70 mm

The switch is mounted in a fascia/control panel in two steps:

1. Insert switch from back side in fascia/control panel
2. Snap on bezel and tighten fixing nut

Lens

Bezel

Illuminated pushbutton



illuminated-/pushbutton 55 - 70 mm sealing gland and -ring

The first time the button is pressed, the gland is forced into its groove and becomes effective.



indicator 30 - 70 mm

The indicator is mounted in a fascia/control panel in two steps:

1. Insert indicator from back side in fascia/control panel
2. Snap on bezel and tighten fixing nut



indicator 30 - 70 mm sealing gland, -ring and press ring

The press ring is fitted between gland and lens. The seal is effective when the lens is snapped into place.



emergency stop switch turn to release 55 - 70 mm

The switch is mounted in a fascia or control panel in three steps:

1. Detach front section just in released position, as in drawing
2. Insert switch from back side in fascia/control panel
3. Snap on front section and tighten fixing nut

Important for IP 65

With models to IP 65, the sealing ring 1) is already fitted. This must be removed if the SWISSTAC emergency Stop identity plate (IP 65 model) is used.

Sealing ring 2) is fitted as standard in models to IP 65.

Zero position Identity plate Wiring diagram



emergency stop switch with key release 55 - 70 mm

The switch is mounted in a fascia or control panel in three steps:

1. Detach front section, just in released position, as in drawing, remove fixing nut
2. Insert switch from back side in fascia/control panel
3. Snap on front section and tighten fixing nut

Important for IP 65

With models to IP 65, the sealing ring1) is already fitted
This must be removed if the SWISSTAC emergency
Stop identity plate (IP 65 model) is used.

Sealing ring2) is fitted as standard
in models to IP 65.

Zero position

Identity plate

Wiring diagram



emergency stop switch foolproof

Hint for mounting: the torque with which the fixing nut is tightened must not exceed 50 Ncm.

Hint for dismantling: dismantling of switching element just with dismantling tool.



keylock switch 45mm

The switch is mounted in a fascia or control panel in three steps:

1. Detach terminal block as in drawing, remove fixing nut
2. Insert switch from front side in fascia/control panel
3. Reassemble the switch in the reverse order

To detach terminal block

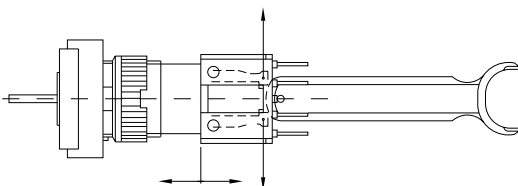

keylock switch 55 mm

The switch is mounted in a fascia/control panel in three steps:

1. Remove front section as in drawing
2. Insert switch from back side in fascia/control panel
3. Snap on front section (see Note) and tighten fixing nut

Zero position

Wiring diagram



To assemble, the key must be at the zero position, the symbol **0** is at the top, and on the terminal block the circuit diagram is uppermost.

keylock switch 70 mm

The switch is mounted in a fascia/control panel in three steps:

1. Remove front section as in drawing
2. Insert switch from back side in fascia/control panel
3. Snap on front section (see Note) and tighten fixing nut.

Zero position

Wiring diagram



To assemble, the key must be at the zero position, the symbol **0** is at the top, and on the terminal block the circuit diagram is uppermost.

selector switch 45 mm

The switch is mounted in a fascia or control panel in three steps:

1. Detach terminal block as in drawing, remove fixing nut
2. Insert switch from front side in fascia/control panel
3. Reassemble the switch in the reverse order

To detach terminal block



selector switch 55 mm

The switch is mounted in a fascia/control panel in three steps:

1. Remove front section as in drawing
2. Insert switch from back side in fascia/control panel
3. Snap on front section (see Note) and tighten fixing nut

Zero position

Wiring diagram



To assemble, the lever must be at the zero position, the symbol **0** is as the top, and on the terminal block the circuit diagram is uppermost.

selector switch 70 mm

The switch is mounted in a fascia/control panel in three steps:

1. Remove front section as in drawing
2. Insert switch from back side in fascia/control panel
3. Snap on front section (see Note) and tighten fixing nut

Zero position

Wiring diagram



To assemble, the lever must be at the zero position, the symbol **0** is at the top, and on the terminal block the circuit diagram is uppermost.

push pull illuminated switch

The switch is mounted in a fascia or control panel in three steps:

1. Detach terminal block as in drawing, remove fixing nut
2. Insert switch from back side in fascia/control panel
3. Reassemble the switch in the reverse order

Push-Pull knob

To detach terminal block



Push-pull knob can be mounted in only one position. Zero position Wiring diagram

buzzer 30 - 55 mm

The alarmbuzzer is mounted in a fascia/control panel in two steps:

1. Insert alarmbuzzer from backside in fascia/control panel
2. snap on bezel and tighten fixing nut

buzzerelement

bezel

buzzerhousing

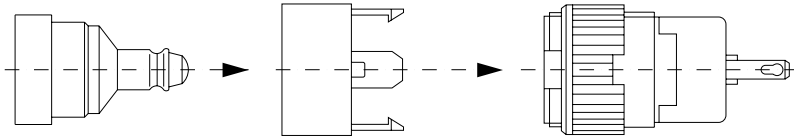

indicator actuator 35 mm



- 🛒 lens for 35 mm page 622
- 🛒 lamp element block for 35 mm page 632
- 🛒 filament lamp MG T 1 3/4 page 634
- 🛒 LED MG T 1 3/4 page 634

	degree of protection	□ 18 x 24 mm Typ-Nr.	⌀ 18 x 18 mm Typ-Nr.	18 mm dia. Typ-Nr.	circuit drawing	technical drawing	mounting dimensions	component layout	📄
indicator actuator 35 mm lampholder MG T 1 3/4	IP 40	690-6000-00	690-4000-00	690-2000-00	1	1	1	1	0,004
	IP 65	690-6000-W0	690-4000-W0	690-2000-W0	1	1	2	1	0,005

circuit drawings from page 657, technical drawings from page 642, mounting dimensions from page 652, component layouts from page 657

indicator 30 - 70 mm

protection degree IP 40/IP 65 is determined by front bezel and lens



- 🛒 lens page 623
- 🛒 front bezel for illuminated-/pushbutton 55 - 70 mm and indicator 30 - 70 mm page 627
- 🛒 pressure ring page 630
- 🛒 filament lamp MG T 1 3/4 page 634
- 🛒 LED MG T 1 3/4 page 634
- 🛒 filament lamp T 5.5 page 634
- 🛒 LED T 5.5 page 635

	mounting depth	connection method	lamp socket	part no.	circuit drawing	technical drawing	mounting dimensions	component layout	📄
indicator 30 - 70 mm	30 mm	-	MG T 1 3/4	990-.000-K0	1	2	3		0,004
	45 mm	-	T 5.5	890-.000-K0	1	3	3		0,006
	52 mm	P	MG T 1 3/4	990-.000-0P	1	4	3	1	0,007
	55 mm	-	MG T 1 3/4	990-.000-00	1	5	3		0,007
	67 mm	P	T 5.5	890-.000-0P	1	6	3	1	0,010
	70 mm	-	T 5.5	890-.000-00	1	7	3		0,010

connection method : soldering-/plug-in terminal = -, PCB terminal = P

The indicators 55 mm and 70 mm are as long as the corresponding illuminated pushbuttons and fit to the PCB plug-in base and multi-plug housing.
circuit drawings from page 657, technical drawings from page 642, mounting dimensions from page 652, component layouts from page 657

pushbutton-/illuminated pushbutton actuator 35 mm



lens for 35 mm page 622

filament lamp MG T 1 3/4 page 634

LED MG T 1 3/4 page 634

snap-action switching element block for 35 mm page 631

	degree of protection	switching action	□ 18 x 24 mm Typ-Nr.	□ 18 x 18 mm Typ-Nr.	18 mm dia. Typ-Nr.	circuit drawing	technical drawing	mounting dimensions	component layout	
pushbutton-/illuminated pushbutton actuator 35 mm lampholder MG T 1 3/4	IP 40	M	680-6000-00	680-4000-00	680-2000-00	2	1	1	1	0,004
		MA	600-6000-00	600-4000-00	600-2000-00	3	1	1	1	0,004
	IP 65	M	680-6000-W0	680-4000-W0	680-2000-W0	2	1	2	1	0,005
		MA	600-6000-W0	600-4000-W0	600-2000-W0	3	1	2	1	0,005

switching action : momentary action = M, maintained action = MA (changeable to momentary action, reversible)

circuit drawings from page 657, technical drawings from page 642, mounting dimensions from page 652, component layouts from page 657

illuminated-/pushbutton 55 - 70 mm

protection degree IP 40/IP 65 is determined by front bezel and lens



- 🛒 lens page 623
- 🛒 front bezel for illuminated-/pushbutton 55 - 70 mm and indicator 30 - 70 mm page 627
- 🛒 filament lamp MG T 1 3/4 page 634
- 🛒 filament lamp T 5.5 page 634
- 🛒 LED T 5.5 page 635

	mounting depth	contacts	switching action	connection method	lamp socket	part no.	circuit drawing	technical drawing	mounting dimensions	component layout	
illuminated-/pushbutton 55 - 70 mm	52 mm	1 NC + 1 NO	MA	P	MG T 1 3/4	901-.000-0P	4	8	3	1	0,013
		2 NC + 2 NO	MA	P	MG T 1 3/4	902-.000-0P	5	8	3	1	0,014
		3 NC + 3 NO	MA	P	MG T 1 3/4	903-.000-0P	6	8	3	1	0,014
		4 NC + 4 NO	MA	P	MG T 1 3/4	904-.000-0P	7	8	3	1	0,018
		5 NC + 5 NO	MA	P	MG T 1 3/4	905-.000-0P	8	8	3	1	0,021
	55 mm	1 NC + 1 NO	MA	-	MG T 1 3/4	901-.000-00	4	9	3		0,013
		2 NC + 2 NO	MA	-	MG T 1 3/4	902-.000-00	5	9	3		0,014
		3 NC + 3 NO	MA	-	MG T 1 3/4	903-.000-00	6	9	3		0,015
		4 NC + 4 NO	MA	-	MG T 1 3/4	904-.000-00	7	9	3		0,019
		5 NC + 5 NO	MA	-	MG T 1 3/4	905-.000-00	8	9	3		0,022
	67 mm	1 NC + 1 NO	MA	P	T 5.5	801-.000-0P	4	10	3	1	0,015
		2 NC + 2 NO	MA	P	T 5.5	802-.000-0P	5	10	3	1	0,016
		3 NC + 3 NO	MA	P	T 5.5	803-.000-0P	6	10	3	1	0,017
		4 NC + 4 NO	MA	P	T 5.5	804-.000-0P	7	10	3	1	0,020
		5 NC + 5 NO	MA	P	T 5.5	805-.000-0P	8	10	3	1	0,023
	70 mm	1 NC + 1 NO	MA	-	T 5.5	801-.000-00	4	11	3		0,015
		2 NC + 2 NO	MA	-	T 5.5	802-.000-00	5	11	3		0,016
		3 NC + 3 NO	MA	-	T 5.5	803-.000-00	6	11	3		0,017
		4 NC + 4 NO	MA	-	T 5.5	804-.000-00	7	11	3		0,021
		5 NC + 5 NO	MA	-	T 5.5	805-.000-00	8	11	3		0,024

contacts : normally closed = NC, normally open = NO

switching action : maintained action = MA (changeable to momentary action, reversible)

connection method : PCB terminal = P, soldering-/plug-in terminal = -

circuit drawings from page 657, technical drawings from page 642, mounting dimensions from page 652, component layouts from page 657

emergency stop switch 55 - 70 mm



🛒 label for emergency stop switch page 636

	unlocking	degree of protection	mounting depth	contacts	connection method	24 mm dia. Typ-Nr.	circuit drawing	technical drawing	mounting dimensions	component layout	
emergency stop switch 55 - 70 mm according to VDE max. 2 NC are permitted	twist to release	IP 40	52 mm	1 NC	P	951+2000-0P	9	12	4	1	0,018
				2 NC	P	952+2000-0P	10	12	4	1	0,019
				3 NC	P	953+2000-0P	11	12	4	1	0,020
			55 mm	1 NC	-	951+2000-00	9	13	4		0,018
				2 NC	-	952+2000-00	10	13	4		0,019
				3 NC	-	953+2000-00	11	13	4		0,020
			67 mm	1 NC	P	851+2000-0P	9	14	4	1	0,021
				2 NC	P	852+2000-0P	10	14	4	1	0,022
				3 NC	P	853+2000-0P	11	14	4	1	0,023
			70 mm	1 NC	-	851+2000-00	9	15	4		0,021
				2 NC	-	852+2000-00	10	15	4		0,022
				3 NC	-	853+2000-00	11	15	4		0,023
		IP 65	52 mm	1 NC	P	951+2000-WP	9	12	5	1	0,018
				2 NC	P	952+2000-WP	10	12	5	1	0,019
				3 NC	P	953+2000-WP	11	12	5	1	0,020
			55 mm	1 NC	-	951+2000-W0	9	13	5		0,018
				2 NC	-	952+2000-W0	10	13	5		0,019
				3 NC	-	953+2000-W0	11	13	5		0,020
			67 mm	1 NC	P	851+2000-WP	9	14	5	1	0,021
				2 NC	P	852+2000-WP	10	14	5	1	0,022
				3 NC	P	853+2000-WP	11	14	5	1	0,023
			70 mm	1 NC	-	851+2000-W0	9	15	5		0,021
				2 NC	-	852+2000-W0	10	15	5		0,022
				3 NC	-	853+2000-W0	11	15	5		0,023

Continued on next page

	unlocking	degree of protection	mounting depth	contacts	connection method	24 mm dia. Typ-Nr.	circuit drawing	technical drawing	mounting dimensions	component layout	
emergency stop switch 55 - 70 mm standard lock B2 390, other lock numbers on request according to VDE max. 2 NC are permitted	key to release	IP 40	52 mm	1 NC	P	961+2401-0P	9	12	4	1	0,030
				2 NC	P	962+2401-0P	10	12	4	1	0,031
				3 NC	P	963+2401-0P	11	12	4	1	0,032
			55 mm	1 NC	-	961+2401-00	9	13	4		0,030
				2 NC	-	962+2401-00	10	13	4		0,031
				3 NC	-	963+2401-00	11	13	4		0,032
			67 mm	1 NC	P	861+2401-0P	9	14	4	1	0,033
				2 NC	P	862+2401-0P	10	14	4	1	0,034
				3 NC	P	863+2401-0P	11	14	4	1	0,035
			70 mm	1 NC	-	861+2401-00	9	15	4		0,033
				2 NC	-	862+2401-00	10	15	4		0,034
				3 NC	-	863+2401-00	11	15	4		0,035
		IP 65	52 mm	1 NC	P	961+2401-WP	9	12	5	1	0,030
				2 NC	P	962+2401-WP	10	12	5	1	0,031
				3 NC	P	963+2401-WP	11	12	5	1	0,032
			55 mm	1 NC	-	961+2401-W0	9	13	5		0,030
				2 NC	-	962+2401-W0	10	13	5		0,031
				3 NC	-	963+2401-W0	11	13	5		0,032
			67 mm	1 NC	P	861+2401-WP	9	14	5	1	0,033
				2 NC	P	862+2401-WP	10	14	5	1	0,034
				3 NC	P	863+2401-WP	11	14	5	1	0,035
			70 mm	1 NC	-	861+2401-W0	9	15	5		0,033
				2 NC	-	862+2401-W0	10	15	5		0,034
				3 NC	-	863+2401-W0	11	15	5		0,035

contacts : 1 normally closed = 1 NC, normally closed = NC

connection method : PCB terminal = P, soldering-/plug-in terminal = -

hint:

- we recommend to use location strip no. 260-0020-00 for anti-twisting of the front bezel.

- at momentary position the overturning force is max. 60 Ncm.

circuit drawings from page 657, technical drawings from page 642, mounting dimensions from page 652, component layouts from page 657

emergency stop switch foolproof 41 mm

according to EN 418



label for emergency stop switch page 636

	unlocking	degree of protection	mounting depth	contacts	connection method	27 mm dia. Typ-Nr.	circuit drawing	technical drawing	mounting dimensions	
emergency stop switch foolproof 41 mm	twist to release	IP 65	41 mm	1 NC	-	551-8000-W0	12	16	6	0,025
				1 NC + 1 NO	-	553-8000-W0	13	16	6	0,025
				2 NC	-	552-8000-W0	14	16	6	0,025
standard lock 1001	key to release	IP 65	41 mm	1 NC	-	561-8101-W0	12	16	6	0,047
				1 NC + 1 NO	-	563-8101-W0	13	16	6	0,047
				2 NC	-	562-8101-W0	14	16	6	0,047

contacts : 1 normally closed = 1 NC, normally closed = NC, normally open = NO

connection method : soldering-/plug-in terminal = -

Mounting hint: starting torque for fixing nut max. 50 Ncm

circuit drawings from page 657, technical drawings from page 642, mounting dimensions from page 652

pushbutton with mushroom-head cap 55 - 70 mm



mushroom-head cap page 625

front bezel for mushroom-head pushbutton 55 - 70 mm page 628

	degree of protection	mounting depth	contacts	switching action	connection method	part no.	circuit drawing	technical drawing	mounting dimensions	component layout	
pushbutton with mushroom-head cap 55 - 70 mm	IP 40	52 mm	1 NC + 1 NO	maintained	P	901-.000-0P	15	17	7	1	0,013
			2 NC + 2 NO	maintained	P	902-.000-0P	16	17	7	1	0,014
			3 NC + 3 NO	maintained	P	903-.000-0P	17	17	7	1	0,014
			4 NC + 4 NO	maintained	P	904-.000-0P	18	17	7	1	0,018
			5 NC + 5 NO	maintained	P	905-.000-0P	19	17	7	1	0,021
		55 mm	1 NC + 1 NO	maintained	-	901-.000-00	15	18	7		0,013
			2 NC + 2 NO	maintained	-	902-.000-00	16	18	7		0,014
			3 NC + 3 NO	maintained	-	903-.000-00	17	18	7		0,015
			4 NC + 4 NO	maintained	-	904-.000-00	18	18	7		0,019
			5 NC + 5 NO	maintained	-	905-.000-00	19	18	7		0,022
		67 mm	1 NC + 1 NO	maintained	P	801-.000-0P	15	19	7	1	0,015
			2 NC + 2 NO	maintained	P	802-.000-0P	16	19	7	1	0,016
			3 NC + 3 NO	maintained	P	803-.000-0P	17	19	7	1	0,017
			4 NC + 4 NO	maintained	P	804-.000-0P	18	19	7	1	0,020
			5 NC + 5 NO	maintained	P	805-.000-0P	19	19	7	1	0,023
		70 mm	1 NC + 1 NO	maintained	-	801-.000-00	15	20	7		0,015
			2 NC + 2 NO	maintained	-	802-.000-00	16	20	7		0,016
			3 NC + 3 NO	maintained	-	803-.000-00	17	20	7		0,017
			4 NC + 4 NO	maintained	-	804-.000-00	18	20	7		0,021
			5 NC + 5 NO	maintained	-	805-.000-00	19	20	7		0,024

contacts : normally closed = NC, normally open = NO

switching action: maintained action = MA (changeable to momentary action, reversible)

connection method : PCB terminal = P, soldering-/plug-in terminal = -

circuit drawings from page 657, technical drawings from page 642, mounting dimensions from page 652, component layouts from page 657

keylock switch 2 positions 45 - 70 mm



front cap for keylock-/selector switch 2 positions page 625

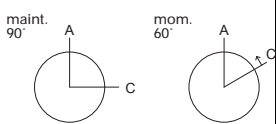

keylock switch 2 positions 45 - 70 mm standard lock B2 300, other lock numbers on re- quest	degree of protec- tion	mounting depth	contacts	switching action	connection method	key removable in	part no.	circuit drawing	technical drawing	mounting dimensions	component layout	IP
	IP 40	42 mm	1 NC + 1 NO	M	P	A	781-.401-0P	21	21	8	1	0,022
				MA	P	A	771-.401-0P	20	21	8	1	0,022
						A+C	761-.401-0P	20	21	8	1	0,022
			2 NC + 2 NO	M	P	A	782-.401-0P	23	21	8	1	0,023
				MA	P	A	772-.401-0P	22	21	8	1	0,023
						A+C	762-.401-0P	22	21	8	1	0,023
		45 mm	1 NC + 1 NO	M	-	A	781-.401-00	21	22	8		0,022
				MA	-	A	771-.401-00	20	22	8		0,022
						A+C	761-.401-00	20	22	8		0,022
			2 NC + 2 NO	M	-	A	782-.401-00	23	22	8		0,023
				MA	-	A	772-.401-00	22	22	8		0,023
						A+C	762-.401-00	22	22	8		0,023
		52 mm	1 NC + 1 NO	M	P	A	931-.401-0P	25	23	8	1	0,024
				MA	P	A	921-.401-0P	24	23	8	1	0,024
						A+C	911-.401-0P	24	23	8	1	0,024
			2 NC + 2 NO	M	P	A	932-.401-0P	23	23	8	1	0,025
				MA	P	A	922-.401-0P	22	23	8	1	0,025
						A+C	912-.401-0P	22	23	8	1	0,025
			3 NC + 3 NO	M	P	A	933-.401-0P	27	23	8	1	0,026
				MA	P	A	923-.401-0P	26	23	8	1	0,026
						A+C	913-.401-0P	26	23	8	1	0,026
			4 NC + 4 NO	M	P	A	934-.401-0P	29	23	8	1	0,029
				MA	P	A	924-.401-0P	28	23	8	1	0,029
						A+C	914-.401-0P	28	23	8	1	0,029
5 NC + 5 NO	M	P	A	935-.401-0P	31	23	8	1	0,032			
	MA	P	A	925-.401-0P	30	23	8	1	0,032			
			A+C	915-.401-0P	30	23	8	1	0,032			

Continued on next page



keylock switch
2 positions 45 - 70 mm
 standard lock B2 300,
 other lock numbers on re-
 quest

degree of protec- tion	mounting depth	contacts	switching action	connection method	key removable in	part no.	circuit drawing	technical drawing	mounting dimensions	component layout	kg		
	55 mm	1 NC + 1 NO	M	-	A	931-.401-00	25	24	8		0,024		
			MA	-	A	921-.401-00	24	24	8		0,024		
				-	A+C	911-.401-00	24	24	8		0,024		
		2 NC + 2 NO	M	-	A	932-.401-00	23	24	8		0,025		
			MA	-	A	922-.401-00	22	24	8		0,025		
				-	A+C	912-.401-00	22	24	8		0,025		
		3 NC + 3 NO	M	-	A	933-.401-00	27	24	8		0,027		
			MA	-	A	923-.401-00	26	24	8		0,027		
				-	A+C	913-.401-00	26	24	8		0,027		
		4 NC + 4 NO	M	-	A	934-.401-00	29	24	8		0,030		
			MA	-	A	924-.401-00	28	24	8		0,030		
				-	A+C	914-.401-00	28	24	8		0,030		
		5 NC + 5 NO	M	-	A	935-.401-00	31	24	8		0,033		
			MA	-	A	925-.401-00	30	24	8		0,033		
				-	A+C	915-.401-00	30	24	8		0,033		
		67 mm	1 NC + 1 NO	M	P	A	831-.401-0P	25	25	8	1	0,026	
					MA	P	A	821-.401-0P	24	25	8	1	0,026
						P	A+C	811-.401-0P	24	25	8	1	0,026
	2 NC + 2 NO			M	P	A	832-.401-0P	23	25	8	1	0,027	
				MA	P	A	822-.401-0P	22	25	8	1	0,027	
					P	A+C	812-.401-0P	22	25	8	1	0,027	
	3 NC + 3 NO		M	P	A	833-.401-0P	27	25	8	1	0,028		
			MA	P	A	823-.401-0P	26	25	8	1	0,028		
				P	A+C	813-.401-0P	26	25	8	1	0,028		
	4 NC + 4 NO		M	P	A	834-.401-0P	29	25	8	1	0,031		
			MA	P	A	824-.401-0P	28	25	8	1	0,031		
				P	A+C	814-.401-0P	28	25	8	1	0,031		
	5 NC + 5 NO		M	P	A	835-.401-0P	31	25	8	1	0,034		
			MA	P	A	825-.401-0P	30	25	8	1	0,034		
				P	A+C	815-.401-0P	30	25	8	1	0,034		
70 mm	1 NC + 1 NO		M	-	A	831-.401-00	25	26	8		0,026		
				MA	-	A	821-.401-00	24	26	8		0,026	
					-	A+C	811-.401-00	24	26	8		0,026	
		2 NC + 2 NO	M	-	A	832-.401-00	23	26	8		0,027		
			MA	-	A	822-.401-00	22	26	8		0,027		
				-	A+C	812-.401-00	22	26	8		0,027		
	3 NC + 3 NO	M	-	A	833-.401-00	27	26	8		0,029			
		MA	-	A	823-.401-00	26	26	8		0,029			
			-	A+C	813-.401-00	26	26	8		0,029			
	4 NC + 4 NO	M	-	A	834-.401-00	29	26	8		0,032			
		MA	-	A	824-.401-00	28	26	8		0,032			
			-	A+C	814-.401-00	28	26	8		0,032			
	5 NC + 5 NO	M	-	A	835-.401-00	31	26	8		0,035			
		MA	-	A	825-.401-00	30	26	8		0,035			
			-	A+C	815-.401-00	30	26	8		0,035			

Continued on next page

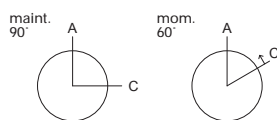

	degree of protection	mounting depth	contacts	switching action	connection method	key removable in	part no.	circuit drawing	technical drawing	mounting dimensions	component layout		
keylock switch 2 positions 45 - 70 mm standard lock B2 300, other lock numbers on re- quest	IP 65	42 mm	1 NC + 1 NO	M	P	A	781-.401-WP	21	21	9	1	0,022	
				MA	P	A	771-.401-WP	20	21	9	1	0,022	
						A+C	761-.401-WP	20	21	9	1	0,022	
			2 NC + 2 NO	M	P	A	782-.401-WP	23	21	9	1	0,023	
				MA	P	A	772-.401-WP	22	21	9	1	0,023	
						A+C	762-.401-WP	22	21	9	1	0,023	
		45 mm	1 NC + 1 NO	M	-	A	781-.401-WO	21	22	9		0,022	
				MA	-	A	771-.401-WO	20	22	9		0,022	
						A+C	761-.401-WO	20	22	9		0,022	
			2 NC + 2 NO	M	-	A	782-.401-WO	23	22	9		0,023	
				MA	-	A	772-.401-WO	22	22	9		0,023	
						A+C	762-.401-WO	22	22	9		0,023	
		52 mm	1 NC + 1 NO	M	P	A	931-.401-WP	25	23	9	1	0,024	
				MA	P	A	921-.401-WP	24	23	9	1	0,024	
						A+C	911-.401-WP	24	23	9	1	0,024	
			2 NC + 2 NO	M	P	A	932-.401-WP	23	23	9	1	0,025	
				MA	P	A	922-.401-WP	22	23	9	1	0,025	
						A+C	912-.401-WP	22	23	9	1	0,025	
			3 NC + 3 NO	M	P	A	933-.401-WP	27	23	9	1	0,026	
				MA	P	A	923-.401-WP	26	23	9	1	0,026	
						A+C	913-.401-WP	26	23	9	1	0,026	
			4 NC + 4 NO	M	P	A	934-.401-WP	29	23	9	1	0,029	
				MA	P	A	924-.401-WP	28	23	9	1	0,029	
						A+C	914-.401-WP	28	23	9	1	0,029	
			5 NC + 5 NO	M	P	A	935-.401-WP	31	23	9	1	0,032	
				MA	P	A	925-.401-WP	30	23	9	1	0,032	
						A+C	915-.401-WP	30	23	9	1	0,032	
			55 mm	1 NC + 1 NO	M	-	A	931-.401-WO	25	24	9		0,024
					MA	-	A	921-.401-WO	24	24	9		0,024
							A+C	911-.401-WO	24	24	9		0,024
		2 NC + 2 NO		M	-	A	932-.401-WO	23	24	9		0,025	
				MA	-	A	922-.401-WO	22	24	9		0,025	
						A+C	912-.401-WO	22	24	9		0,025	
		3 NC + 3 NO		M	-	A	933-.401-WO	27	24	9		0,027	
				MA	-	A	923-.401-WO	26	24	9		0,027	
						A+C	913-.401-WO	26	24	9		0,027	
		4 NC + 4 NO		M	-	A	934-.401-WO	29	24	9		0,030	
				MA	-	A	924-.401-WO	28	24	9		0,030	
						A+C	914-.401-WO	28	24	9		0,030	
		5 NC + 5 NO		M	-	A	935-.401-WO	31	24	9		0,033	
				MA	-	A	925-.401-WO	30	24	9		0,033	
						A+C	915-.401-WO	30	24	9		0,033	

Continued on next page

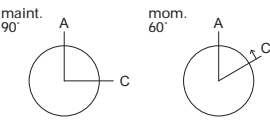

keylock switch 2 positions 45 - 70 mm standard lock B2 300, other lock numbers on re- quest	degree of protec- tion	mounting depth	contacts	switching action	connection method	key removable in	part no.	circuit drawing	technical drawing	mounting dimensions	component layout	kg	
		67 mm	1 NC + 1 NO	M	P	A	831-.401-WP	25	25	9	1	0,026	
				MA	P	A	821-.401-WP	24	25	9	1	0,026	
						A+C	811-.401-WP	24	25	9	1	0,026	
			2 NC + 2 NO	M	P	A	832-.401-WP	23	25	9	1	0,027	
				MA	P	A	822-.401-WP	22	25	9	1	0,027	
						A+C	812-.401-WP	22	25	9	1	0,027	
			3 NC + 3 NO	M	P	A	833-.401-WP	27	25	9	1	0,028	
				MA	P	A	823-.401-WP	26	25	9	1	0,028	
						A+C	813-.401-WP	26	25	9	1	0,028	
			4 NC + 4 NO	M	P	A	834-.401-WP	29	25	9	1	0,031	
				MA	P	A	824-.401-WP	28	25	9	1	0,031	
						A+C	814-.401-WP	28	25	9	1	0,031	
		5 NC + 5 NO	M	P	A	835-.401-WP	31	25	9	1	0,034		
			MA	P	A	825-.401-WP	30	25	9	1	0,034		
					A+C	815-.401-WP	30	25	9	1	0,034		
		70 mm		1 NC + 1 NO	M	-	A	831-.401-WO	25	26	9		0,026
					MA	-	A	821-.401-WO	24	26	9		0,026
							A+C	811-.401-WO	24	26	9		0,026
				2 NC + 2 NO	M	-	A	832-.401-WO	23	26	9		0,027
					MA	-	A	822-.401-WO	22	26	9		0,027
							A+C	812-.401-WO	22	26	9		0,027
				3 NC + 3 NO	M	-	A	833-.401-WO	27	26	9		0,029
					MA	-	A	823-.401-WO	26	26	9		0,029
							A+C	813-.401-WO	26	26	9		0,029
4 NC + 4 NO	M			-	A	834-.401-WO	29	26	9		0,032		
	MA			-	A	824-.401-WO	28	26	9		0,032		
					A+C	814-.401-WO	28	26	9		0,032		
5 NC + 5 NO	M	-	A	835-.401-WO	31	26	9		0,035				
	MA	-	A	825-.401-WO	30	26	9		0,035				
			A+C	815-.401-WO	30	26	9		0,035				

contacts : normally closed = NC, normally open = NO

switching action : maintained action = MA, momentary action = M

connection method : PCB terminal = P, soldering-/plug-in terminal = -

other key removable combination on request

hint:

- we recommend to use location strip no. 260-0020-00 for anti-twisting of the front bezel.

- at momentary position the overturning force is max. 60 Ncm.

circuit drawings from page 657, technical drawings from page 642, mounting dimensions from page 652, component layouts from page 657

keylock switch 3 positions 45 mm



front cap for keylock-/selector switch 3 positions page 626

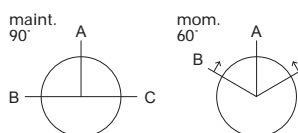

	degree of protection	mounting depth	contacts	switching action	connection method	key removable in	part no.	circuit drawing	technical drawing	mounting dimensions	component layout	
keylock switch 3 positions 45 mm standard lock B2 300, other lock numbers on request	IP 40	42 mm	2 NC + 2 NO	0 - MA - MA	P	B+A+C	722-.401-0P	32	21	8	1	0,023
				M - 0 - M	P	A	732-.401-0P	33	21	8	1	0,023
				M - 0 - MA	P	A+C	752-.401-0P	35	21	8	1	0,023
				MA - 0 - M	P	B+A	742-.401-0P	34	21	8	1	0,023
				MA - 0 - MA	P	B+A+C	712-.401-0P	32	21	8	1	0,023
		45 mm	2 NC + 2 NO	0 - MA - MA	-	B+A+C	722-.401-00	32	22	8		0,023
				M - 0 - M	-	A	732-.401-00	33	22	8		0,023
				M - 0 - MA	-	A+C	752-.401-00	35	22	8		0,023
				MA - 0 - M	-	B+A	742-.401-00	34	22	8		0,023
				MA - 0 - MA	-	B+A+C	712-.401-00	32	22	8		0,023
	IP 65	42 mm	2 NC + 2 NO	0 - MA - MA	P	B+A+C	722-.401-WP	32	21	9	1	0,023
				M - 0 - M	P	A	732-.401-WP	33	21	9	1	0,023
				M - 0 - MA	P	A+C	752-.401-WP	35	21	9	1	0,023
				MA - 0 - M	P	B+A	742-.401-WP	34	21	9	1	0,023
				MA - 0 - MA	P	B+A+C	712-.401-WP	32	21	9	1	0,023
		45 mm	2 NC + 2 NO	0 - MA - MA	-	B+A+C	722-.401-W0	32	22	9		0,023
M - 0 - M				-	A	732-.401-W0	33	22	9		0,023	
M - 0 - MA				-	A+C	752-.401-W0	35	22	9		0,023	
MA - 0 - M				-	B+A	742-.401-W0	34	22	9		0,023	
MA - 0 - MA				-	B+A+C	712-.401-W0	32	22	9		0,023	

contacts : normally closed = NC, normally open = NO

switching action: maintained action = MA, momentary action = M

connection method : PCB terminal = P, soldering-/plug-in terminal = -

other key removable combination on request

hint:

- we recommend to use location strip no. 260-0020-00 for anti-twisting of the front bezel.

- at momentary position the overturning force is max. 60 Ncm.

circuit drawings from page 657, technical drawings from page 642, mounting dimensions from page 652, component layouts from page 657

selector switch 2 positions 45 - 70 mm



🛒 front cap for keylock-/selector switch 2 positions page 625

🛒 lever page 627



selector switch 2 positions 45 - 70 mm	degree of protection	mounting depth	contacts	switching action	connection method	part no.	circuit drawing	technical drawing	mounting dimensions	component layout	📄	
selector switch 2 positions 45 - 70 mm	IP 40	42 mm	1 NC + 1 NO	M	P	781-.700-0P	37	27	10	1	0,011	
				MA	P	761-.700-0P	36	27	10	1	0,011	
			2 NC + 2 NO	M	P	782-.700-0P	39	27	10	1	0,012	
				MA	P	762-.700-0P	38	27	10	1	0,012	
		45 mm	1 NC + 1 NO	M	-	781-.700-00	37	28	10		0,011	
				MA	-	761-.700-00	36	28	10		0,011	
			2 NC + 2 NO	M	-	782-.700-00	39	28	10		0,012	
				MA	-	762-.700-00	38	28	10		0,012	
			52 mm	1 NC + 1 NO	M	P	931-.700-0P	41	29	10	1	0,013
					MA	P	911-.700-0P	40	29	10	1	0,013
		2 NC + 2 NO		M	P	932-.700-0P	39	29	10	1	0,014	
				MA	P	912-.700-0P	38	29	10	1	0,014	
		3 NC + 3 NO		M	P	933-.700-0P	43	29	10	1	0,015	
				MA	P	913-.700-0P	42	29	10	1	0,015	
		4 NC + 4 NO		M	P	934-.700-0P	45	29	10	1	0,018	
				MA	P	914-.700-0P	44	29	10	1	0,018	
		5 NC + 5 NO		M	P	935-.700-0P	47	29	10	1	0,022	
				MA	P	915-.700-0P	46	29	10	1	0,022	
		55 mm	1 NC + 1 NO	M	-	931-.700-00	41	30	10		0,013	
				MA	-	911-.700-00	40	30	10		0,013	
			2 NC + 2 NO	M	-	932-.700-00	39	30	10		0,014	
				MA	-	912-.700-00	38	30	10		0,014	
			3 NC + 3 NO	M	-	933-.700-00	43	30	10		0,015	
				MA	-	913-.700-00	42	30	10		0,015	
			4 NC + 4 NO	M	-	934-.700-00	45	30	10		0,019	
				MA	-	914-.700-00	44	30	10		0,019	
			5 NC + 5 NO	M	-	935-.700-00	47	30	10		0,023	
				MA	-	915-.700-00	46	30	10		0,023	
		67 mm	1 NC + 1 NO	M	P	831-.700-0P	41	31	10	1	0,015	
				MA	P	811-.700-0P	40	31	10	1	0,015	
			2 NC + 2 NO	M	P	832-.700-0P	39	31	10	1	0,016	
				MA	P	812-.700-0P	38	31	10	1	0,016	
			3 NC + 3 NO	M	P	833-.700-0P	43	31	10	1	0,017	
				MA	P	813-.700-0P	42	31	10	1	0,017	
			4 NC + 4 NO	M	P	834-.700-0P	45	31	10	1	0,020	
				MA	P	814-.700-0P	44	31	10	1	0,020	
			5 NC + 5 NO	M	P	835-.700-0P	47	31	10	1	0,024	
				MA	P	815-.700-0P	46	31	10	1	0,024	

Continued on next page

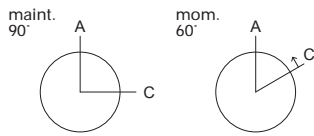

	degree of protection	mounting depth	contacts	switching action	connection method	part no.	circuit drawing	technical drawing	mounting dimensions	component layout	(%)		
selector switch 2 positions 45 - 70 mm	IP 40	70 mm	1 NC + 1 NO	M	-	831-.700-00	41	32	10		0,015		
				MA	-	811-.700-00	40	32	10		0,015		
			2 NC + 2 NO	M	-	832-.700-00	39	32	10		0,016		
				MA	-	812-.700-00	38	32	10		0,016		
			3 NC + 3 NO	M	-	833-.700-00	43	32	10		0,017		
				MA	-	813-.700-00	42	32	10		0,017		
			4 NC + 4 NO	M	-	834-.700-00	45	32	10		0,021		
				MA	-	814-.700-00	44	32	10		0,021		
			5 NC + 5 NO	M	-	835-.700-00	47	32	10		0,025		
				MA	-	815-.700-00	46	32	10		0,025		
			IP 65	42 mm	1 NC + 1 NO	M	P	781-.700-WP	37	27	11	1	0,011
						MA	P	761-.700-WP	36	27	11	1	0,011
	2 NC + 2 NO	M			P	782-.700-WP	39	27	11	1	0,012		
		MA			P	762-.700-WP	38	27	11	1	0,012		
	45 mm	1 NC + 1 NO			M	-	781-.700-W0	37	28	11		0,011	
					MA	-	761-.700-W0	36	28	11		0,011	
		2 NC + 2 NO			M	-	782-.700-W0	39	28	11		0,012	
					MA	-	762-.700-W0	38	28	11		0,012	
	52 mm	1 NC + 1 NO			M	P	931-.700-WP	41	29	11	1	0,013	
					MA	P	911-.700-WP	40	29	11	1	0,013	
		2 NC + 2 NO			M	P	932-.700-WP	39	29	11	1	0,014	
					MA	P	912-.700-WP	38	29	11	1	0,014	
		3 NC + 3 NO		M	P	933-.700-WP	43	29	11	1	0,015		
				MA	P	913-.700-WP	42	29	11	1	0,015		
4 NC + 4 NO		M		P	934-.700-WP	45	29	11	1	0,018			
		MA		P	914-.700-WP	44	29	11	1	0,018			
5 NC + 5 NO		M		P	935-.700-WP	47	29	11	1	0,022			
		MA		P	915-.700-WP	46	29	11	1	0,022			
55 mm		1 NC + 1 NO		M	-	931-.700-W0	41	30	11		0,013		
				MA	-	911-.700-W0	40	30	11		0,013		
	2 NC + 2 NO	M		-	932-.700-W0	39	30	11		0,014			
		MA		-	912-.700-W0	38	30	11		0,014			
	3 NC + 3 NO	M		-	933-.700-W0	43	30	11		0,015			
		MA		-	913-.700-W0	42	30	11		0,015			
	4 NC + 4 NO	M		-	934-.700-W0	45	30	11		0,019			
		MA		-	914-.700-W0	44	30	11		0,019			
	5 NC + 5 NO	M		-	935-.700-W0	47	30	11		0,023			
		MA		-	915-.700-W0	46	30	11		0,023			
	67 mm	1 NC + 1 NO		M	P	831-.700-WP	41	31	11	1	0,015		
				MA	P	811-.700-WP	40	31	11	1	0,015		
2 NC + 2 NO		M		P	832-.700-WP	39	31	11	1	0,016			
		MA		P	812-.700-WP	38	31	11	1	0,016			
3 NC + 3 NO		M		P	833-.700-WP	43	31	11	1	0,017			
		MA		P	813-.700-WP	42	31	11	1	0,017			
4 NC + 4 NO		M		P	834-.700-WP	45	31	11	1	0,020			
		MA		P	814-.700-WP	44	31	11	1	0,020			
5 NC + 5 NO		M	P	835-.700-WP	47	31	11	1	0,024				
		MA	P	815-.700-WP	46	31	11	1	0,024				

Continued on next page

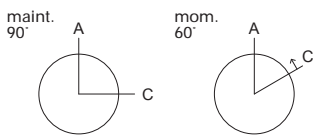

	degree of protection	mounting depth	contacts	switching action	connection method	part no.	circuit drawing	technical drawing	mounting dimensions	component layout	
selector switch 2 positions 45 - 70 mm	IP 65	70 mm	1 NC + 1 NO	M	-	831-.700-W0	41	32	11		0,015
				MA	-	811-.700-W0	40	32	11		0,015
			2 NC + 2 NO	M	-	832-.700-W0	39	32	11		0,016
				MA	-	812-.700-W0	38	32	11		0,016
			3 NC + 3 NO	M	-	833-.700-W0	43	32	11		0,017
				MA	-	813-.700-W0	42	32	11		0,017
			4 NC + 4 NO	M	-	834-.700-W0	45	32	11		0,021
				MA	-	814-.700-W0	44	32	11		0,021
			5 NC + 5 NO	M	-	835-.700-W0	47	32	11		0,025
				MA	-	815-.700-W0	46	32	11		0,025

contacts : normally closed = NC, normally open = NO

switching action : maintained action = MA, momentary action = M

connection method : PCB terminal = P, soldering-/plug-in terminal = -

hint:

- we recommend to use location strip no. 260-0020-00 for anti-twisting of the front bezel.

- at momentary position the overturning force is max. 60 Ncm.

circuit drawings from page 657, technical drawings from page 642, mounting dimensions from page 652, component layouts from page 657

selector switch 3 positions 45 mm



☞ front cap for keylock-/selector switch 3 positions page 626

☞ lever page 627

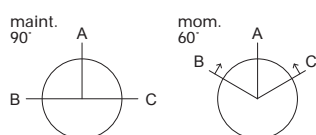

	degree of protection	mounting depth	contacts	switching action	connection method	part no.	circuit drawing	technical drawing	mounting dimensions	component layout	
selector switch 3 positions 45 mm	IP 40	42 mm	2 NC + 2 NO	0 - MA - MA	P	722-.700-0P	48	27	10	1	0,012
				M - 0 - M	P	732-.700-0P	49	27	10	1	0,012
				M - 0 - MA	P	752-.700-0P	51	27	10	1	0,012
				MA - 0 - M	P	742-.700-0P	50	27	10	1	0,012
				MA - 0 - MA	P	712-.700-0P	48	27	10	1	0,012
		45 mm	2 NC + 2 NO	0 - MA - MA	-	722-.700-00	48	28	10		0,012
				M - 0 - M	-	732-.700-00	49	28	10		0,012
				M - 0 - MA	-	752-.700-00	51	28	10		0,012
				MA - 0 - M	-	742-.700-00	50	28	10		0,012
				MA - 0 - MA	-	712-.700-00	48	28	10		0,012
	IP 65	42 mm	2 NC + 2 NO	0 - MA - MA	P	722-.700-WP	48	27	11	1	0,012
				M - 0 - M	P	732-.700-WP	49	27	11	1	0,012
				M - 0 - MA	P	752-.700-WP	51	27	11	1	0,012
				MA - 0 - M	P	742-.700-WP	50	27	11	1	0,012
				MA - 0 - MA	P	712-.700-WP	48	27	11	1	0,012
		45 mm	2 NC + 2 NO	0 - MA - MA	-	722-.700-W0	48	28	11		0,012
				M - 0 - M	-	732-.700-W0	49	28	11		0,012
				M - 0 - MA	-	752-.700-W0	51	28	11		0,012
				MA - 0 - M	-	742-.700-W0	50	28	11		0,012
				MA - 0 - MA	-	712-.700-W0	48	28	11		0,012

contacts : normally closed = NC, normally open = NO

switching action: maintained action = MA, momentary action = M

connection method : PCB terminal = P, soldering-/plug-in terminal = -

hint:

- we recommend to use location strip no. 260-0020-00 for anti-twisting of the front bezel.

- at momentary position the overturning force is max. 60 Ncm.

circuit drawings from page 657, technical drawings from page 642, mounting dimensions from page 652, component layouts from page 657

buzzer 30 - 55 mm



🛒 buzzer element page 627

🛒 front bezel for buzzer 30 - 55 mm page 628

	degree of protection	mounting depth	connection method	buzzer socket	part no.	circuit drawing	technical drawing	mounting dimensions	component layout	
buzzer 30 - 55 mm	IP 40	30 mm	-	MG T 1 3/4	970-000-K0	52	2	12		0,004
		52 mm	P	MG T 1 3/4	970-000-0P	52	4	12	1	0,007
		55 mm	-	MG T 1 3/4	970-000-00	52	5	12		0,007

connection method : soldering-/plug-in terminal = -, PCB terminal = P

the buzzer 55 mm is as long as the corresponding illuminated pushbutton and fits to the PCB plug-in base and multi plug housing

circuit drawings from page 657, technical drawings from page 642, mounting dimensions from page 652, component layouts from page 657

push-pull illuminated switch 45 mm



🛒 push-pull knob page 627

🛒 filament lamp MG T 1 3/4 page 634

🛒 LED MG T 1 3/4 page 634

	mounting depth	contacts	switching action	connection method	colour of front bezel	18 mm dia. Typ-Nr.	circuit drawing	technical drawing	mounting dimensions	component layout	
push-pull illuminated switch 45 mm IP 40, lampholder MG T 1 3/4	42 mm	2 NC + 2 NO	M - 0 - M	P	grey	792-1000-0P	53	33	13	1	0,015
					black	792-2000-0P	53	33	13	1	0,015
	45 mm	2 NC + 2 NO	M - 0 - M	-	grey	792-1000-00	53	34	13		0,015
					black	792-2000-00	53	34	13		0,015

contacts : normally closed = NC, normally open = NO

switching action: maintained action = MA, momentary action = M

connection method : PCB terminal = P, soldering-/plug-in terminal = -

circuit drawings from page 657, technical drawings from page 642, mounting dimensions from page 652, component layouts from page 657

indicator actuator 41-44 mm for flush mounting



- 🛒 lens for 35 mm page 622
- 🛒 front bezel-set for flush mounting page 628
- 🛒 filament lamp MG T 1 3/4 page 634
- 🛒 LED MG T 1 3/4 page 634
- 🛒 lamp element block for 35 mm page 632

	degree of protection	a 24 x 30 mm part no.	b 24 x 24 mm part no.	25 mm dia. part no.	circuit drawing	technical drawing	mounting dimension	components layout	
indicator actuator 41-44 mm for flush mounting lamp socket MG T 1 3/4	IP 40	690-6000-00	690-4000-00	690-2000-00	1	35	14	-	0,004
	IP 65	690-6000-W0	690-4000-W0	690-2000-W0	1	35	14	-	0,005

circuit drawings from page 657, technical drawings from page 642, mounting dimensions from page 652

indicator for flush mounting 39 - 79 mm

protection degree IP 40



- 🛒 lens page 623
- 🛒 front bezel for indicator 39 - 79 mm page 627
- 🛒 front bezel-set for flush mounting page 628
- 🛒 filament lamp MG T 1 3/4 page 634
- 🛒 LED MG T 1 3/4 page 634
- 🛒 filament lamp T 5.5 page 634
- 🛒 LED T 5.5 page 635

	mounting depth	connection method	lamp socket	part no.	circuit drawing	technical drawing	mounting dimensions	component layout	
indicator for flush mounting 39 - 79 mm	39 mm	-	MG T 1 3/4	990-.000-K0	1	36	14		0,004
	54 mm	-	T 5.5	890-.000-K0	1	37	14		0,006
	61 mm	P	MG T 1 3/4	990-.000-0P	1	38	14	1	0,007
	64 mm	-	MG T 1 3/4	990-.000-00	1	39	14		0,007
	76 mm	P	T 5.5	890-.000-0P	1	40	14	1	0,010
	79 mm	-	T 5.5	890-.000-00	1	41	14		0,010

connection method : soldering-/plug-in terminal = -, PCB terminal = P

The indicators 55 mm and 70 mm are as long as the corresponding illuminated pushbuttons and fit to the PCB plug-in base and multi-plug housing. circuit drawings from page 657, technical drawings from page 642, mounting dimensions from page 652, component layouts from page 657

illuminated-/pushbutton actuator 41-44 mm for flush mounting



- ☞ lens page 623
- ☞ filament lamp MG T 1 3/4 page 634
- ☞ LED MG T 1 3/4 page 634
- ☞ snap-action switching element block for 35 mm page 631

	degree of protection	switching action	component layout		25 mm dia. Typ-Nr.	circuit drawing			technical drawing			mounting dimensions
			□ 24 x 30 mm Typ-Nr.	⌀ 24 x 24 mm Typ-Nr.								
illuminated-/pushbutton actuator 41-44 mm for flush mounting	IP 40	M			680-2000-00	54	35	14	0,004			
				680-4000-00		54	35	14	0,004			
			680-6000-00		54	35	14	0,004				
		MA (M)		600-2000-00	55	35	14	0,004				
				600-4000-00	55	35	14	0,004				
			600-6000-00	55	35	14	0,004					
	IP 65	M			680-2000-W0	54	35	14	0,005			
				680-4000-W0		54	35	14	0,005			
			680-6000-W0		54	35	14	0,005				
		MA (M)		600-2000-W0	55	35	14	0,005				
				600-4000-W0	55	35	14	0,005				
			600-6000-W0	55	35	14	0,005					

switching action : momentary action = M, maintained action = MA

circuit drawings from page 657, technical drawings from page 642, mounting dimensions from page 652

pushbutton-/illuminated pushbutton for flush mounting 61 - 79 mm

protection degree IP 40



- 🛒 lens page 623
- 🛒 front bezel for illuminated-/pushbutton 61 - 79 mm page 627
- 🛒 front bezel-set for flush mounting page 628
- 🛒 filament lamp MG T 1 3/4 page 634
- 🛒 LED MG T 1 3/4 page 634
- 🛒 filament lamp T 5.5 page 634
- 🛒 LED T 5.5 page 635

	mounting depth	contacts	switching action	connection method	lamp socket	part no.	circuit drawing	technical drawing	mounting dimensions	component layout	
pushbutton-/illuminated pushbutton for flush mounting 61 - 79 mm	61 mm	1 NC + 1 NO	maintained	P	MG T 1 3/4	901-000-0P	4	42	14	1	0,013
		2 NC + 2 NO	maintained	P	MG T 1 3/4	902-000-0P	5	42	14	1	0,014
		3 NC + 3 NO	maintained	P	MG T 1 3/4	903-000-0P	6	42	14	1	0,014
		4 NC + 4 NO	maintained	P	MG T 1 3/4	904-000-0P	7	42	14	1	0,018
		5 NC + 5 NO	maintained	P	MG T 1 3/4	905-000-0P	8	42	14	1	0,021
	64 mm	1 NC + 1 NO	maintained	-	MG T 1 3/4	901-000-00	4	43	14		0,013
		2 NC + 2 NO	maintained	-	MG T 1 3/4	902-000-00	5	43	14		0,014
		3 NC + 3 NO	maintained	-	MG T 1 3/4	903-000-00	6	43	14		0,015
		4 NC + 4 NO	maintained	-	MG T 1 3/4	904-000-00	7	43	14		0,019
		5 NC + 5 NO	maintained	-	MG T 1 3/4	905-000-00	8	43	14		0,022
	76 mm	1 NC + 1 NO	maintained	P	T 5.5	801-000-0P	4	44	14	1	0,015
		2 NC + 2 NO	maintained	P	T 5.5	802-000-0P	5	44	14	1	0,016
		3 NC + 3 NO	maintained	P	T 5.5	803-000-0P	6	44	14	1	0,014
		4 NC + 4 NO	maintained	P	T 5.5	804-000-0P	7	44	14	1	0,020
		5 NC + 5 NO	maintained	P	T 5.5	805-000-0P	8	44	14	1	0,023
	79 mm	1 NC + 1 NO	maintained	-	T 5.5	801-000-00	4	45	14		0,015
		2 NC + 2 NO	maintained	-	T 5.5	802-000-00	5	45	14		0,016
		3 NC + 3 NO	maintained	-	T 5.5	803-000-00	6	45	14		0,017
		4 NC + 4 NO	maintained	-	T 5.5	804-000-00	7	45	14		0,021
		5 NC + 5 NO	maintained	-	T 5.5	805-000-00	8	45	14		0,024

contacts : normally closed = NC, normally open = NO

switching action: (changeable to momentary, reversible)

connection method : PCB terminal = P, soldering-/plug-in terminal = -

circuit drawings from page 657, technical drawings from page 642, mounting dimensions from page 652, component layouts from page 657

keylock switch 2 positions for flush mounting 51 - 79 mm



☞ front cap for keylock-/selector switch 2 positions page 625

☞ front bezel-set for flush mounting page 628

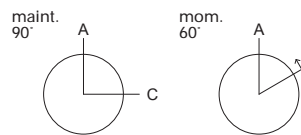

	degree of protection	mounting depth	contacts	switching action	connection method	key removable in	part no.	circuit drawing	technical drawing	mounting dimensions	component layout	
keylock switch 2 positions for flush mounting 51 - 79 mm	IP 40	51 mm	1 NC + 1 NO	M	P	A	781-.401-0P	21	46	14	1	0,022
				MA	P	A	771-.401-0P	20	46	14	1	0,022
						A+C	761-.401-0P	20	46	14	1	0,022
			2 NC + 2 NO	M	P	A	782-.401-0P	23	46	14	1	0,023
				MA	P	A	772-.401-0P	22	46	14	1	0,023
						A+C	762-.401-0P	22	46	14	1	0,023
		54 mm	1 NC + 1 NO	M	-	A	781-.401-00	21	47	14		0,022
				MA	-	A	771-.401-00	20	47	14		0,022
						A+C	761-.401-00	20	47	14		0,022
			2 NC + 2 NO	M	-	A	782-.401-00	23	47	14		0,023
				MA	-	A	772-.401-00	22	47	14		0,023
						A+C	762-.401-00	22	47	14		0,023
		61 mm	1 NC + 1 NO	M	P	A	931-.401-0P	25	48	14	1	0,024
				MA	P	A	921-.401-0P	24	48	14	1	0,024
						A+C	911-.401-0P	24	48	14	1	0,024
			2 NC + 2 NO	M	P	A	932-.401-0P	23	48	14	1	0,025
				MA	P	A	922-.401-0P	22	48	14	1	0,025
						A+C	912-.401-0P	22	48	14	1	0,025
			3 NC + 3 NO	M	P	A	933-.401-0P	27	48	14	1	0,026
				MA	P	A	923-.401-0P	26	48	14	1	0,026
						A+C	913-.401-0P	26	48	14	1	0,026
			4 NC + 4 NO	M	P	A	934-.401-0P	29	48	14	1	0,029
				MA	P	A	924-.401-0P	28	48	14	1	0,029
						A+C	914-.401-0P	28	48	14	1	0,029
5 NC + 5 NO	M		P	A	935-.401-0P	31	48	14	1	0,032		
	MA		P	A	925-.401-0P	30	48	14	1	0,032		
				A+C	915-.401-0P	30	48	14	1	0,032		

Continued on next page

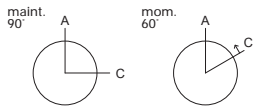

keylock switch 2 positions for flush mounting 51 - 79 mm	degree of protection	mounting depth	contacts	switching action	connection method	key remova- ble in	part no.	circuit drawing	technical drawing	mounting dimensions	component layout	④	
keylock switch 2 positions for flush mounting 51 - 79 mm	IP 40	64 mm	1 NC + 1 NO	M	-	A	931-.401-00	25	49	14		0,024	
				MA	-	A	921-.401-00	24	49	14		0,024	
						A+C	911-.401-00	24	49	14		0,024	
			2 NC + 2 NO	M	-	A	932-.401-00	23	49	14		0,025	
				MA	-	A	922-.401-00	22	49	14		0,025	
						A+C	912-.401-00	22	49	14		0,025	
			3 NC + 3 NO	M	-	A	933-.401-00	27	49	14		0,027	
				MA	-	A	923-.401-00	26	49	14		0,027	
						A+C	913-.401-00	26	49	14		0,027	
			4 NC + 4 NO	M	-	A	934-.401-00	29	49	14		0,030	
				MA	-	A	924-.401-00	28	49	14		0,030	
						A+C	914-.401-00	28	49	14		0,030	
			5 NC + 5 NO	M	-	A	935-.401-00	31	49	14		0,033	
				MA	-	A	925-.401-00	30	49	14		0,033	
						A+C	915-.401-00	30	49	14		0,033	
			76 mm	1 NC + 1 NO	M	P	A	831-.401-0P	25	50	14	1	0,026
					MA	P	A	821-.401-0P	24	50	14	1	0,026
							A+C	811-.401-0P	24	50	14	1	0,026
		2 NC + 2 NO		M	P	A	832-.401-0P	23	50	14	1	0,027	
				MA	P	A	822-.401-0P	22	50	14	1	0,027	
						A+C	812-.401-0P	22	50	14	1	0,027	
		3 NC + 3 NO		M	P	A	833-.401-0P	27	50	14	1	0,028	
				MA	P	A	823-.401-0P	26	50	14	1	0,028	
						A+C	813-.401-0P	26	50	14	1	0,028	
		4 NC + 4 NO		M	P	A	834-.401-0P	29	50	14	1	0,031	
				MA	P	A	824-.401-0P	28	50	14	1	0,031	
						A+C	814-.401-0P	28	50	14	1	0,031	
		5 NC + 5 NO		M	P	A	835-.401-0P	31	50	14	1	0,034	
				MA	P	A	825-.401-0P	30	50	14	1	0,034	
						A+C	815-.401-0P	30	50	14	1	0,034	
		79 mm		1 NC + 1 NO	M	-	A	831-.401-00	25	51	14		0,026
					MA	-	A	821-.401-00	24	51	14		0,026
							A+C	811-.401-00	24	51	14		0,026
			2 NC + 2 NO	M	-	A	832-.401-00	23	51	14		0,027	
				MA	-	A	822-.401-00	22	51	14		0,027	
						A+C	812-.401-00	22	51	14		0,027	
			3 NC + 3 NO	M	-	A	833-.401-00	27	51	14		0,029	
				MA	-	A	823-.401-00	26	51	14		0,029	
						A+C	813-.401-00	26	51	14		0,029	
			4 NC + 4 NO	M	-	A	834-.401-00	29	51	14		0,032	
				MA	-	A	824-.401-00	28	51	14		0,032	
						A+C	814-.401-00	28	51	14		0,032	
			5 NC + 5 NO	M	-	A	835-.401-00	31	51	14		0,035	
				MA	-	A	825-.401-00	30	51	14		0,035	
						A+C	815-.401-00	30	51	14		0,035	
IP 65	51 mm		1 NC + 1 NO	M	P	A	781-.401-WP	21	46	14	1	0,022	
				MA	P	A	771-.401-WP	20	46	14	1	0,022	
						A+C	761-.401-WP	20	46	14	1	0,022	
		2 NC + 2 NO	M	P	A	782-.401-WP	23	46	14	1	0,023		
			MA	P	A	772-.401-WP	22	46	14	1	0,023		
					A+C	762-.401-WP	22	46	14	1	0,023		

Continued on next page

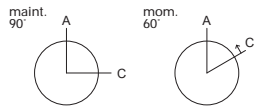

	degree of protection	mounting depth	contacts	switching action	connection method	key removable in	part no.	circuit drawing	technical drawing	mounting dimensions	component layout		
keylock switch 2 positions for flush mounting 51 - 79 mm	IP 65	54 mm	1 NC + 1 NO	M	-	A	781-.401-W0	21	47	14		0,022	
				MA	-	A	771-.401-W0	20	47	14		0,022	
						A+C	761-.401-W0	20	47	14		0,022	
			2 NC + 2 NO	M	-	A	782-.401-W0	23	47	14		0,023	
				MA	-	A	772-.401-W0	22	47	14		0,023	
						A+C	762-.401-W0	22	47	14		0,023	
		61 mm	1 NC + 1 NO	M	P	A	931-.401-WP	25	48	14	1	0,024	
				MA	P	A	921-.401-WP	24	48	14	1	0,024	
						A+C	911-.401-WP	24	48	14	1	0,024	
			2 NC + 2 NO	M	P	A	932-.401-WP	23	48	14	1	0,025	
				MA	P	A	922-.401-WP	22	48	14	1	0,025	
						A+C	912-.401-WP	22	48	14	1	0,025	
			3 NC + 3 NO	M	P	A	933-.401-WP	27	48	14	1	0,026	
				MA	P	A	923-.401-WP	26	48	14	1	0,026	
						A+C	913-.401-WP	26	48	14	1	0,026	
			4 NC + 4 NO	M	P	A	934-.401-WP	29	48	14	1	0,029	
				MA	P	A	924-.401-WP	28	48	14	1	0,029	
						A+C	914-.401-WP	28	48	14	1	0,029	
			5 NC + 5 NO	M	P	A	935-.401-WP	31	48	14	1	0,032	
				MA	P	A	925-.401-WP	30	48	14	1	0,032	
						A+C	915-.401-WP	30	48	14	1	0,032	
			64 mm	1 NC + 1 NO	M	-	A	931-.401-W0	25	49	14		0,024
					MA	-	A	921-.401-W0	24	49	14		0,024
							A+C	911-.401-W0	24	49	14		0,024
		2 NC + 2 NO		M	-	A	932-.401-W0	23	49	14		0,025	
				MA	-	A	922-.401-W0	22	49	14		0,025	
						A+C	912-.401-W0	22	49	14		0,025	
		3 NC + 3 NO		M	-	A	933-.401-W0	27	49	14		0,027	
				MA	-	A	923-.401-W0	26	49	14		0,027	
						A+C	913-.401-W0	26	49	14		0,027	
		4 NC + 4 NO		M	-	A	934-.401-W0	29	49	14		0,030	
				MA	-	A	924-.401-W0	28	49	14		0,030	
						A+C	914-.401-W0	28	49	14		0,030	
		5 NC + 5 NO		M	-	A	935-.401-W0	31	49	14		0,033	
				MA	-	A	925-.401-W0	30	49	14		0,033	
						A+C	915-.401-W0	30	49	14		0,033	
		76 mm		1 NC + 1 NO	M	P	A	831-.401-WP	25	50	14	1	0,026
					MA	P	A	821-.401-WP	24	50	14	1	0,026
							A+C	811-.401-WP	24	50	14	1	0,026
			2 NC + 2 NO	M	P	A	832-.401-WP	23	50	14	1	0,027	
				MA	P	A	822-.401-WP	22	50	14	1	0,027	
						A+C	812-.401-WP	22	50	14	1	0,027	
			3 NC + 3 NO	M	P	A	833-.401-WP	27	50	14	1	0,028	
				MA	P	A	823-.401-WP	26	50	14	1	0,028	
						A+C	813-.401-WP	26	50	14	1	0,028	
			4 NC + 4 NO	M	P	A	834-.401-WP	29	50	14	1	0,031	
				MA	P	A	824-.401-WP	28	50	14	1	0,031	
						A+C	814-.401-WP	28	50	14	1	0,031	
5 NC + 5 NO	M		P	A	835-.401-WP	31	50	14	1	0,034			
	MA		P	A	825-.401-WP	30	50	14	1	0,034			
				A+C	815-.401-WP	30	50	14	1	0,034			

Continued on next page

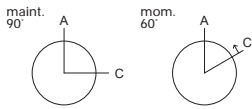

	degree of protection	mounting depth	contacts	switching action	connection method	key removable in	part no.	circuit drawing	technical drawing	mounting dimensions	component layout	
keylock switch 2 positions for flush mounting 51 - 79 mm	IP 65	79 mm	1 NC + 1 NO	M	-	A	831-.401-W0	25	51	14		0,026
				MA	-	A	821-.401-W0	24	51	14		0,026
					-	A+C	811-.401-W0	24	51	14		0,026
			2 NC + 2 NO	M	-	A	832-.401-W0	23	51	14		0,027
				MA	-	A	822-.401-W0	22	51	14		0,027
					-	A+C	812-.401-W0	22	51	14		0,027
			3 NC + 3 NO	M	-	A	833-.401-W0	27	51	14		0,029
				MA	-	A	823-.401-W0	26	51	14		0,029
					-	A+C	813-.401-W0	26	51	14		0,029
			4 NC + 4 NO	M	-	A	834-.401-W0	29	51	14		0,032
				MA	-	A	824-.401-W0	28	51	14		0,032
					-	A+C	814-.401-W0	28	51	14		0,032
			5 NC + 5 NO	M	-	A	835-.401-W0	31	51	14		0,035
				MA	-	A	825-.401-W0	30	51	14		0,035
					-	A+C	815-.401-W0	30	51	14		0,035

contacts : normally closed = NC, normally open = NO

switching action : maintained action = MA, momentary action = M

connection method : PCB terminal = P, soldering-/plug-in terminal = -

other key removable combination on request

hint:

- we recommend to use location strip no. 260-0020-00 for anti-twisting of the front bezel.

- at momentary position the overturning force is max. 60 Ncm.

circuit drawings from page 657, technical drawings from page 642, mounting dimensions from page 652, component layouts from page 657

keylock switch with 3 positions for flush mounting 51 - 54 mm



🛒 front cap for keylock-/selector switch 3 positions 626

🛒 front bezel-set for flush mounting page 628



	degree of protection	mounting depth	contacts	switching action	connection method	key removable in	part no.	circuit drawing	technical drawing	mounting dimensions	component layout	
keylock switch with 3 positions for flush mounting 51 - 54 mm	IP 40	51 mm	2 NC + 2 NO	0 - MA - MA	P	B+A+C	722-.401-0P	32	46	14	1	0,023
				M - 0 - M	P	A	732-.401-0P	33	46	14	1	0,023
				M - 0 - MA	P	A+C	752-.401-0P	35	46	14	1	0,023
				MA - 0 - M	P	B+A	742-.401-0P	34	46	14	1	0,023
				MA - 0 - MA	P	B+A+C	712-.401-0P	32	46	14	1	0,023
		54 mm	2 NC + 2 NO	0 - MA - MA	-	B+A+C	722-.401-00	32	47	14		0,023
				M - 0 - M	-	A	732-.401-00	33	47	14		0,023
				M - 0 - MA	-	A+C	752-.401-00	35	47	14		0,023
	IP 65	51 mm	2 NC + 2 NO	0 - MA - MA	P	B+A+C	722-.401-WP	32	46	14	1	0,023
				M - 0 - M	P	A	732-.401-WP	33	46	14	1	0,023
				M - 0 - MA	P	A+C	752-.401-WP	35	46	14	1	0,023
				MA - 0 - M	P	B+A	742-.401-WP	34	46	14	1	0,023
				MA - 0 - MA	P	B+A+C	712-.401-WP	32	46	14	1	0,023
		54 mm	2 NC + 2 NO	0 - MA - MA	-	B+A+C	722-.401-W0	32	47	14		0,023
				M - 0 - M	-	A	732-.401-W0	33	47	14		0,023
				M - 0 - MA	-	A+C	752-.401-W0	35	47	14		0,023
			MA - 0 - M	-	B+A	742-.401-W0	34	47	14		0,023	
			MA - 0 - MA	-	B+A+C	712-.401-W0	32	47	14		0,023	

contacts : normally closed = NC, normally open = NO

switching action : maintained action = MA, momentary action = M

connection method : PCB terminal = P, soldering-/plug-in terminal = -

other key removable combination on request

hint:

- we recommend to use location strip no. 260-0020-00 for anti-twisting of the front bezel.

- at momentary position the overturning force is max. 60 Ncm.

circuit drawings from page 657, technical drawings from page 642, mounting dimensions from page 652, component layouts from page 657

selector switch 2 positions for flush mounting 51 - 79 mm



🛒 front cap for keylock-/selector switch 2 positions page 625

🛒 lever page 627

🛒 front bezel-set for flush mounting page 628

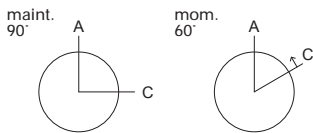

selector switch 2 positions for flush mounting 51 - 79 mm	degree of protection	mounting depth	contacts	switching action	connection method	part no.	circuit drawing	technical drawing	mounting dimensions	component layout	📄
selector switch 2 positions for flush mounting 51 - 79 mm	IP 40	51 mm	1 NC + 1 NO	M	P	781-.700-0P	37	52	15	1	0,011
				MA	P	761-.700-0P	36	52	15	1	0,011
			2 NC + 2 NO	M	P	782-.700-0P	39	52	15	1	0,012
				MA	P	762-.700-0P	38	52	15	1	0,012
		54 mm	1 NC + 1 NO	M	-	781-.700-00	37	53	15		0,011
				MA	-	761-.700-00	36	53	15		0,011
			2 NC + 2 NO	M	-	782-.700-00	39	53	15		0,012
				MA	-	762-.700-00	38	53	15		0,012
		61 mm	1 NC + 1 NO	M	P	931-.700-0P	41	54	15	1	0,013
				MA	P	911-.700-0P	40	54	15	1	0,013
			2 NC + 2 NO	M	P	932-.700-0P	39	54	15	1	0,014
				MA	P	912-.700-0P	38	54	15	1	0,014
			3 NC + 3 NO	M	P	933-.700-0P	43	54	15	1	0,015
				MA	P	913-.700-0P	42	54	15	1	0,015
			4 NC + 4 NO	M	P	934-.700-0P	45	54	15	1	0,018
				MA	P	914-.700-0P	44	54	15	1	0,018
			5 NC + 5 NO	M	P	935-.700-0P	47	54	15	1	0,022
				MA	P	915-.700-0P	46	54	15	1	0,022
		64 mm	1 NC + 1 NO	M	-	931-.700-00	41	55	15		0,013
				MA	-	911-.700-00	40	55	15		0,013
			2 NC + 2 NO	M	-	932-.700-00	39	55	15		0,014
				MA	-	912-.700-00	38	55	15		0,014
			3 NC + 3 NO	M	-	933-.700-00	43	55	15		0,015
				MA	-	913-.700-00	42	55	15		0,015
			4 NC + 4 NO	M	-	934-.700-00	45	55	15		0,019
				MA	-	914-.700-00	44	55	15		0,019
			5 NC + 5 NO	M	-	935-.700-00	47	55	15		0,023
				MA	-	915-.700-00	46	55	15		0,023

Continued on next page

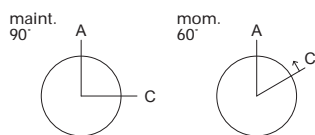

	degree of protection	mounting depth	contacts	switching action	connection method	part no.	circuit drawing	technical drawing	mounting dimensions	component layout		
selector switch 2 positions for flush mounting 51 - 79 mm	IP 65	76 mm	1 NC + 1 NO	M	P	831-.700-0P	41	56	15	1	0,015	
				MA	P	811-.700-0P	40	56	15	1	0,015	
			2 NC + 2 NO	M	P	832-.700-0P	39	56	15	1	0,016	
				MA	P	812-.700-0P	38	56	15	1	0,016	
			3 NC + 3 NO	M	P	833-.700-0P	43	56	15	1	0,017	
				MA	P	813-.700-0P	42	56	15	1	0,017	
			4 NC + 4 NO	M	P	834-.700-0P	45	56	15	1	0,020	
				MA	P	814-.700-0P	44	56	15	1	0,020	
			5 NC + 5 NO	M	P	835-.700-0P	47	56	15	1	0,024	
				MA	P	815-.700-0P	46	56	15	1	0,024	
			79 mm	1 NC + 1 NO	M	-	831-.700-00	41	57	15		0,015
					MA	-	811-.700-00	40	57	15		0,015
		2 NC + 2 NO		M	-	832-.700-00	39	57	15		0,016	
				MA	-	812-.700-00	38	57	15		0,016	
		3 NC + 3 NO		M	-	833-.700-00	43	57	15		0,017	
				MA	-	813-.700-00	42	57	15		0,017	
		4 NC + 4 NO		M	-	834-.700-00	45	57	15		0,021	
				MA	-	814-.700-00	44	57	15		0,021	
		5 NC + 5 NO		M	-	835-.700-00	47	57	15		0,025	
				MA	-	815-.700-00	46	57	15		0,025	
		51 mm		1 NC + 1 NO	M	P	781-.700-WP	37	52	15	1	0,011
					MA	P	761-.700-WP	36	52	15	1	0,011
			2 NC + 2 NO	M	P	782-.700-WP	39	52	15	1	0,012	
				MA	P	762-.700-WP	38	52	15	1	0,012	
		54 mm	1 NC + 1 NO	M	-	781-.700-W0	37	53	15		0,011	
				MA	-	761-.700-W0	36	53	15		0,011	
			2 NC + 2 NO	M	-	782-.700-W0	39	53	15		0,012	
				MA	-	762-.700-W0	38	53	15		0,012	
		61 mm	1 NC + 1 NO	M	P	931-.700-WP	41	54	15	1	0,013	
				MA	P	911-.700-WP	40	54	15	1	0,013	
			2 NC + 2 NO	M	P	932-.700-WP	39	54	15	1	0,014	
				MA	P	912-.700-WP	38	54	15	1	0,014	
			3 NC + 3 NO	M	P	933-.700-WP	43	54	15	1	0,015	
				MA	P	913-.700-WP	42	54	15	1	0,015	
			4 NC + 4 NO	M	P	934-.700-WP	45	54	15	1	0,018	
				MA	P	914-.700-WP	44	54	15	1	0,018	
			5 NC + 5 NO	M	P	935-.700-WP	47	54	15	1	0,022	
				MA	P	915-.700-WP	46	54	15	1	0,022	
			64 mm	1 NC + 1 NO	M	-	931-.700-W0	41	55	15		0,013
					MA	-	911-.700-W0	40	55	15		0,013
		2 NC + 2 NO		M	-	932-.700-W0	39	55	15		0,014	
				MA	-	912-.700-W0	38	55	15		0,014	
		3 NC + 3 NO		M	-	933-.700-W0	43	55	15		0,015	
				MA	-	913-.700-W0	42	55	15		0,015	
		4 NC + 4 NO		M	-	934-.700-W0	45	55	15		0,019	
				MA	-	914-.700-W0	44	55	15		0,019	
		5 NC + 5 NO		M	-	935-.700-W0	47	55	15		0,023	
				MA	-	915-.700-W0	46	55	15		0,023	

Continued on next page

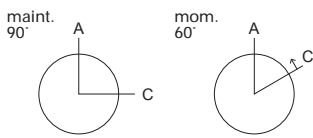

	degree of protection	mounting depth	contacts	switching action	connection method	part no.	circuit drawing	technical drawing	mounting dimensions	component layout	
selector switch 2 positions for flush mounting 51 - 79 mm	IP 65	76 mm	1 NC + 1 NO	M	P	831-.700-WP	41	56	15	1	0,015
				MA	P	811-.700-WP	40	56	15	1	0,015
			2 NC + 2 NO	M	P	832-.700-WP	39	56	15	1	0,016
				MA	P	812-.700-WP	38	56	15	1	0,016
			3 NC + 3 NO	M	P	833-.700-WP	43	56	15	1	0,017
				MA	P	813-.700-WP	42	56	15	1	0,017
			4 NC + 4 NO	M	P	834-.700-WP	45	56	15	1	0,020
				MA	P	814-.700-WP	44	56	15	1	0,020
			5 NC + 5 NO	M	P	835-.700-WP	47	56	15	1	0,024
				MA	P	815-.700-WP	46	56	15	1	0,024
		79 mm	1 NC + 1 NO	M	-	831-.700-WO	41	57	15		0,015
				MA	-	811-.700-WO	40	57	15		0,015
			2 NC + 2 NO	M	-	832-.700-WO	39	57	15		0,016
				MA	-	812-.700-WO	38	57	15		0,016
			3 NC + 3 NO	M	-	833-.700-WO	43	57	15		0,017
				MA	-	813-.700-WO	42	57	15		0,017
			4 NC + 4 NO	M	-	834-.700-WO	45	57	15		0,021
				MA	-	814-.700-WO	44	57	15		0,021
			5 NC + 5 NO	M	-	835-.700-WO	47	57	15		0,025
				MA	-	815-.700-WO	46	57	15		0,025

contacts : normally closed = NC, normally open = NO

switching action : maintained action = MA, momentary action = M

connection method : PCB terminal = P, soldering-/plug-in terminal = -

hint:

- we recommend to use location strip no. 260-0020-00 for anti-twisting of the front bezel.

- at momentary position the overturning force is max. 60 Ncm.

circuit drawings from page 657, technical drawings from page 642, mounting dimensions from page 652, component layouts from page 657

selector switch 3 positions for flush mounting 51 - 54 mm



🛒 front cap for keylock-/selector switch 3 positions page 626

🛒 lever page 627

🛒 front bezel-set for flush mounting page 628

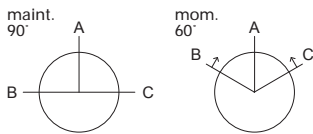

	degree of protection	mounting depth	contacts	switching action	connection method	part no.	circuit drawing	technical drawing	mounting dimensions	component layout	
selector switch 3 positions for flush mounting 51 - 54 mm	IP 40	51 mm	2 NC + 2 NO	0 - MA - MA	P	722-.700-0P	48	52	15	1	0,012
				M - 0 - M	P	732-.700-0P	49	52	15	1	0,012
				M - 0 - MA	P	752-.700-0P	51	52	15	1	0,012
				MA - 0 - M	P	742-.700-0P	50	52	15	1	0,012
				MA - 0 - MA	P	712-.700-0P	48	52	15	1	0,012
		54 mm	0 - MA - MA	-	722-.700-00	48	53	15		0,012	
			M - 0 - M	-	732-.700-00	49	53	15		0,012	
			M - 0 - MA	-	752-.700-00	51	53	15		0,012	
			MA - 0 - M	-	742-.700-00	50	53	15		0,012	
			MA - 0 - MA	-	712-.700-00	48	53	15		0,012	
	IP 65	51 mm	2 NC + 2 NO	0 - MA - MA	P	722-.700-WP	48	52	15	1	0,012
				M - 0 - M	P	732-.700-WP	49	52	15	1	0,012
				M - 0 - MA	P	752-.700-WP	51	52	15	1	0,012
				MA - 0 - M	P	742-.700-WP	50	52	15	1	0,012
				MA - 0 - MA	P	712-.700-WP	48	52	15	1	0,012
		54 mm	0 - MA - MA	-	722-.700-W0	48	53	15		0,012	
			M - 0 - M	-	732-.700-W0	49	53	15		0,012	
			M - 0 - MA	-	752-.700-W0	51	53	15		0,012	
			MA - 0 - M	-	742-.700-W0	50	53	15		0,012	
			MA - 0 - MA	-	712-.700-W0	48	53	15		0,012	

contacts : normally closed = NC, normally open = NO

switching action: maintained action = MA, momentary action = M

connection method : PCB terminal = P, soldering-/plug-in terminal = -

hint:

- we recommend to use location strip no. 260-0020-00 for anti-twisting of the front bezel.

- at momentary position the overturning force is max. 60 Ncm.

circuit drawings from page 657, technical drawings from page 642, mounting dimensions from page 652, component layouts from page 657

buzzer for flush mounting 39 - 64 mm



- 🛒 buzzer element page 627
- 🛒 front bezel for buzzer 30 - 55 mm page 628
- 🛒 front bezel set for flush mounting for buzzer page 628

	degree of protection	mounting depth	connection method	buzzer socket	part no.	circuit drawing	technical drawing	mounting dimensions	component layout	
buzzer for flush mounting 39 - 64 mm	IP 40	39 mm	-	MG T 1 3/4	970-.000-K0	52	36	16		0,004
		61 mm	P	MG T 1 3/4	970-.000-0P	52	38	16	1	0,007
		64 mm	-	MG T 1 3/4	970-.000-00	52	39	16		0,007

connection method : soldering-/plug-in terminal = -, PCB terminal = P

the buzzer 55 mm is as long as the corresponding illuminated pushbutton and fits to the PCB plug-in base and multi plug housing

circuit drawings from page 657, technical drawings from page 642, mounting dimensions from page 652, component layouts from page 657

at front

lens for 35 mm

for pushbuttons 35 mm

	shape	lens/support	colour	⌀ 18 x 24 mm Typ-Nr.	⌀ 18 x 18 mm Typ-Nr.	18 mm dia. Typ-Nr.	
lens for 35 mm of plastic	flat	transparent/translucent	blue	600-5150-00	600-3150-00	600-1150-00	0,001
			yellow	600-5170-00	600-3170-00	600-1170-00	0,001
			green	600-5140-00	600-3140-00	600-1140-00	0,001
			orange	600-5110-00	600-3110-00	600-1110-00	0,001
			red	600-5120-00	600-3120-00	600-1120-00	0,001
			white	600-5160-00	600-3160-00	600-1160-00	0,001
of plastic (not recommended for film insert)	flat	transparent/translucent	blue	600-5250-00	600-3250-00	600-1250-00	0,001
			yellow	600-5270-00	600-3270-00	600-1270-00	0,001
			green	600-5240-00	600-3240-00	600-1240-00	0,001
			orange	600-5210-00	600-3210-00	600-1210-00	0,001
			red	600-5220-00	600-3220-00	600-1220-00	0,001
			white	600-5260-00	600-3260-00	600-1260-00	0,001
of plastic (not for film insert and illumination)	flat	opaque/translucent	grey	600-5180-00	600-3180-00	600-1180-00	0,001
			black	600-5190-00	600-3190-00	600-1190-00	0,001



lens

	degree of protection	front dimension pushbutton	shape	lens/support	colour	part no.	
lens of plastic	IP 40	18 x 18 mm	flat	transparent/translucent	blue	200-3150-00	0,001
					yellow	200-3170-00	0,001
					green	200-3140-00	0,001
					orange	200-3110-00	0,001
					red	200-3120-00	0,001
		white	200-3160-00	0,001			
		18 x 24 mm	flat	transparent/translucent	blue	200-5150-00	0,001
					yellow	200-5170-00	0,001
					green	200-5140-00	0,001
					orange	200-5110-00	0,001
					red	200-5120-00	0,001
		white	200-5160-00	0,001			
		24 x 24 mm	flat	transparent/translucent	blue	200-9150-00	0,001
					yellow	200-9170-00	0,001
					green	200-9140-00	0,001
					orange	200-9110-00	0,001
					red	200-9120-00	0,001
		white	200-9160-00	0,001			
		18 mm dia.	flat	transparent/translucent	blue	200-1150-00	0,001
					yellow	200-1170-00	0,001
	green				200-1140-00	0,001	
	orange				200-1110-00	0,001	
	red				200-1120-00	0,001	
	white	200-1160-00	0,001				
	24 mm dia.	flat	transparent/translucent	blue	200-7150-00	0,001	
				yellow	200-7170-00	0,001	
				green	200-7140-00	0,001	
				orange	200-7110-00	0,001	
				red	200-7120-00	0,001	
	white	200-7160-00	0,001				
	IP 65	24 x 24 mm	flat	transparent/translucent	blue	200-9150-W0	0,002
					yellow	200-9170-W0	0,002
					green	200-9140-W0	0,002
					orange	200-9110-W0	0,002
					red	200-9120-W0	0,002
		white	200-9160-W0	0,002			
		24 mm dia.	flat	transparent/translucent	blue	200-7150-W0	0,002
					yellow	200-7170-W0	0,002
					green	200-7140-W0	0,002
					orange	200-7110-W0	0,002
red	200-7120-W0				0,002		
white	200-7160-W0	0,002					



Continued on next page

lens of plastic (not recommended for film insert)	IP 40	18 x 18 mm	flat	transparent/ transparent	blue	200-3250-00	0,001
					yellow	200-3270-00	0,001
					green	200-3240-00	0,001
					orange	200-3210-00	0,001
					red	200-3220-00	0,001
		white	200-3260-00	0,001			
		18 x 24 mm	flat	transparent/ transparent	blue	200-5250-00	0,001
					yellow	200-5270-00	0,001
					green	200-5240-00	0,001
					orange	200-5210-00	0,001
					red	200-5220-00	0,001
		white	200-5260-00	0,001			
		24 x 24 mm	flat	transparent/ transparent	blue	200-9250-00	0,001
					yellow	200-9270-00	0,001
					green	200-9240-00	0,001
	orange				200-9210-00	0,001	
	red				200-9220-00	0,001	
	white	200-9260-00	0,001				
	18 mm dia.	flat	transparent/ transparent	blue	200-1250-00	0,001	
				yellow	200-1270-00	0,001	
green				200-1240-00	0,001		
orange				200-1210-00	0,001		
red				200-1220-00	0,001		
white	200-1260-00	0,001					
24 mm dia.	flat	transparent/ transparent	blue	200-7250-00	0,001		
			yellow	200-7270-00	0,001		
			green	200-7240-00	0,001		
			orange	200-7210-00	0,001		
			red	200-7220-00	0,001		
white	200-7260-00	0,001					
IP 65	24 x 24 mm	flat	transparent/ transparent	blue	200-9250-W0	0,002	
				yellow	200-9270-W0	0,002	
				green	200-9240-W0	0,002	
				orange	200-9210-W0	0,002	
				red	200-9220-W0	0,002	
	white	200-9260-W0	0,002				
	24 mm dia.	flat	transparent/ transparent	blue	200-7250-W0	0,002	
				yellow	200-7270-W0	0,002	
				green	200-7240-W0	0,002	
				orange	200-7210-W0	0,002	
red				200-7220-W0	0,002		
white	200-7260-W0	0,002					
of plastic (not for film insert and illumination)	IP 40	18 x 18 mm	flat	opaque/translucent	grey	200-3180-00	0,001
					black	200-3190-00	0,001
		18 x 24 mm	flat	opaque/translucent	grey	200-5180-00	0,001
					black	200-5190-00	0,001
		24 x 24 mm	flat	opaque/translucent	grey	200-9180-00	0,001
					black	200-9190-00	0,001
		18 mm dia.	flat	opaque/translucent	grey	200-1180-00	0,001
					black	200-1190-00	0,001
		24 mm dia.	flat	opaque/translucent	grey	200-7180-00	0,001
					black	200-7190-00	0,001
	IP 65	24 x 24 mm	flat	opaque/translucent	grey	200-9180-W0	0,002
					black	200-9190-W0	0,002
		24 mm dia.	flat	opaque/translucent	grey	200-7180-W0	0,002
	black				200-7190-W0	0,002	

mushroom-head cap

can only be used with front bezel 18 mm dia.

	degree of protection	mushroom	colour	☐ 18 x 24 mm Typ-Nr.	☐ 24 x 24 mm Typ-Nr.	24 mm dia. Typ-Nr.	
mushroom-head cap	IP 40	opaque	yellow	200-5370-00	200-9370-00	200-7370-00	0,005
			green	200-5340-00	200-9340-00	200-7340-00	0,005
			red	200-5320-00	200-9320-00	200-7320-00	0,005
			black	200-5390-00	200-9390-00	200-7390-00	0,005



front cap for keylock-/selector switch 2 positions

for IP 40/IP 65, will be delivered assembled

	front dimension pushbutton	for switching action	marking	colour	part no.	
front cap for keylock-/selector switch 2 positions plastic, for types 761-... - 772-..., 911-... - 925-..., 811-... - 825-...	18 x 18 mm	0 - MA	0 - I (90°)	grey	200-3001-00	0,002
				black	200-4001-00	0,002
	18 x 24 mm	0 - MA	0 - I (90°)	grey	200-5001-00	0,002
				black	200-6001-00	0,002
	24 x 24 mm	0 - MA	0 - I (90°)	grey	200-9001-00	0,002
				black	200-0001-00	0,002
	18 mm dia.	0 - MA	0 - I (90°)	grey	200-1001-00	0,002
				black	200-2001-00	0,002
	24 mm dia.	0 - MA	0 - I (90°)	grey	200-7001-00	0,002
				black	200-8001-00	0,002
plastic, for types 781-... - 782-..., 931-... - 935-..., 831-... - 835-...	18 x 18 mm	0 - M	0 - I (60°)	grey	200-3001-01	0,002
				black	200-4001-01	0,002
	18 x 24 mm	0 - M	0 - I (60°)	grey	200-5001-01	0,002
				black	200-6001-01	0,002
	24 x 24 mm	0 - M	0 - I (60°)	grey	200-9001-01	0,002
				black	200-0001-01	0,002
	18 mm dia.	0 - M	0 - I (60°)	grey	200-1001-01	0,002
				black	200-2001-01	0,002
	24 mm dia.	0 - M	0 - I (60°)	grey	200-7001-01	0,002
				black	200-8001-01	0,002
of plastic, fits for all types	18 x 18 mm	M- or MA action	without marking	grey	200-3004-00	0,002
				black	200-4004-00	0,002
	18 x 24 mm	M- or MA action	without marking	grey	200-5004-00	0,002
				black	200-6004-00	0,002
	24 x 24 mm	M- or MA action	without marking	grey	200-9004-00	0,002
				black	200-0004-00	0,002
	18 mm dia.	M- or MA action	without marking	grey	200-1004-00	0,002
				black	200-2004-00	0,002
	24 mm dia.	M- or MA action	without marking	grey	200-7004-00	0,002
				black	200-8004-00	0,002



front cap for keylock-/selector switch 3 positions

for IP 40/IP 65, will be delivered assembled

	front dimension	for switching action	marking	colour	part no.	
front cap for keylock-/selector switch 3 positions plastic, for type 712-...	18 x 18 mm	M - 0 - M	I (90°) - 0 - II (90°)	grey	200-3002-00	0,002
				black	200-4002-00	0,002
	18 x 24 mm	M - 0 - M	I (90°) - 0 - II (90°)	grey	200-5002-00	0,002
				black	200-6002-00	0,002
	24 x 24 mm	M - 0 - M	I (90°) - 0 - II (90°)	grey	200-9002-00	0,002
				black	200-0002-00	0,002
	18 mm dia.	M - 0 - M	I (90°) - 0 - II (90°)	grey	200-1002-00	0,002
				black	200-2002-00	0,002
	24 mm dia.	M - 0 - M	I (90°) - 0 - II (90°)	grey	200-7002-00	0,002
				black	200-8002-00	0,002
plastic, for type 722-...	18 x 18 mm	0 - M - M	0 (90°) - I - II (90°)	grey	200-3003-01	0,002
				black	200-4003-01	0,002
	18 x 24 mm	0 - M - M	0 (90°) - I - II (90°)	grey	200-5003-01	0,002
				black	200-6003-01	0,002
	24 x 24 mm	0 - M - M	0 (90°) - I - II (90°)	grey	200-9003-01	0,002
				black	200-0003-01	0,002
	18 mm dia.	0 - M - M	0 (90°) - I - II (90°)	grey	200-1003-01	0,002
				black	200-2003-01	0,002
	24 mm dia.	0 - M - M	0 (90°) - I - II (90°)	grey	200-7003-01	0,002
				black	200-8003-01	0,002
plastic, for type 732-...	18 x 18 mm	M - 0 - M	I (60°) - 0 - II (60°)	grey	200-3002-02	0,002
				black	200-4002-02	0,002
	18 x 24 mm	M - 0 - M	I (60°) - 0 - II (60°)	grey	200-5002-02	0,002
				black	200-6002-02	0,002
	24 x 24 mm	M - 0 - M	I (60°) - 0 - II (60°)	grey	200-9002-02	0,002
				black	200-0002-02	0,002
	18 mm dia.	M - 0 - M	I (60°) - 0 - II (60°)	grey	200-1002-02	0,002
				black	200-2002-02	0,002
	24 mm dia.	M - 0 - M	I (60°) - 0 - II (60°)	grey	200-7002-02	0,002
				black	200-8002-02	0,002
plastic, for type 742-...	18 x 18 mm	MA - 0 - M	I (90°) - 0 - II (60°)	grey	200-3002-03	0,002
				black	200-4002-03	0,002
	18 x 24 mm	MA - 0 - M	I (90°) - 0 - II (60°)	grey	200-5002-03	0,002
				black	200-6002-03	0,002
	24 x 24 mm	MA - 0 - M	I (90°) - 0 - II (60°)	grey	200-9002-03	0,002
				black	200-0002-03	0,002
	18 mm dia.	MA - 0 - M	I (90°) - 0 - II (60°)	grey	200-1002-03	0,002
				black	200-2002-03	0,002
	24 mm dia.	MA - 0 - M	I (90°) - 0 - II (60°)	grey	200-7002-03	0,002
				black	200-8002-03	0,002
plastic, for type 752-...	18 x 18 mm	M - 0 - MA	I (60°) - 0 - II (90°)	grey	200-3002-04	0,002
				black	200-4002-04	0,002
	18 x 24 mm	M - 0 - MA	I (60°) - 0 - II (90°)	grey	200-5002-04	0,002
				black	200-6002-04	0,002
	24 x 24 mm	M - 0 - MA	I (60°) - 0 - II (90°)	grey	200-9002-04	0,002
				black	200-0002-04	0,002
	18 mm dia.	M - 0 - MA	I (60°) - 0 - II (90°)	grey	200-1002-04	0,002
				black	200-2002-04	0,002
	24 mm dia.	M - 0 - MA	I (60°) - 0 - II (90°)	grey	200-7002-04	0,002
				black	200-8002-04	0,002



Continued on next page

front cap for keylock-/selector switch 3 positions of plastic, fits for all types	18 x 18 mm	M- or MA action	without marking	grey	200-3004-00	0,002
				black	200-4004-00	0,002
	18 x 24 mm	M- or MA action	without marking	grey	200-5004-00	0,002
				black	200-6004-00	0,002
	24 x 24 mm	M- or MA action	without marking	grey	200-9004-00	0,002
				black	200-0004-00	0,002
	18 mm dia.	M- or MA action	without marking	grey	200-1004-00	0,002
				black	200-2004-00	0,002
	24 mm dia.	M- or MA action	without marking	grey	200-7004-00	0,002
				black	200-8004-00	0,002

lever

will be delivered assembled

	construction	colour	part no.	
lever	short	black	200-.704-00	0,001
		chromium-plated	200-.604-00	0,001
	long	black	200-.904-00	0,001
		chromium-plated	200-.804-00	0,001



buzzer element

	voltage	colour	18 x 24 mm Typ-Nr.	24 x 24 mm Typ-Nr.	
buzzer element	6 V AC/DC	grey	970-5006-00	970-9006-00	0,004
		black	970-6006-00	970-0006-00	0,004
	12 V AC/DC	grey	970-5012-00	970-9012-00	0,004
		black	970-6012-00	970-0012-00	0,004
	24 V AC/DC	grey	970-5024-00	970-9024-00	0,004
		black	970-6024-00	970-0024-00	0,004



push-pull knob

	knob	colour	part no.	
push-pull knob	transparent	blue	200-.255-00	0,003
		yellow	200-.275-00	0,003
		green	200-.245-00	0,003
		red	200-.225-00	0,003
		white	200-.265-00	0,003



front bezel for illuminated-/pushbutton 55 - 70 mm and indicator 30 - 70 mm

	degree of protection	front dimension	material	colour	part no.	
front bezel for illuminated-/pushbutton 55 - 70 mm and indicator 30 - 70 mm	IP 40	18 x 18 mm	plastic	grey	200-3000-00	0,002
				black	200-4000-00	0,002
		18 x 24 mm	plastic	grey	200-5000-00	0,002
				black	200-6000-00	0,002
		24 x 24 mm	plastic	grey	200-9000-00	0,002
				black	200-0000-00	0,002
		18 mm dia.	plastic	grey	200-1000-00	0,002
				black	200-2000-00	0,002
		24 mm dia.	plastic	grey	200-7000-00	0,002
				black	200-8000-00	0,002
	IP 65	24 x 24 mm	plastic	grey	200-9000-W0	0,002
				black	200-0000-W0	0,002
		24 mm dia.	plastic	grey	200-7000-W0	0,002
				black	200-8000-W0	0,002





front bezel for mushroom-head pushbutton 55 - 70 mm

	degree of protection	material	colour	18 mm dia. Typ-Nr.	
front bezel for mushroom-head pushbutton 55 - 70 mm	IP 40	plastic	grey	200-1000-00	0,002
			black	200-2000-00	0,002



front bezel for buzzer 30 - 55 mm

	degree of protection	material	colour	 18 x 24 mm Typ-Nr.	 24 x 24 mm Typ-Nr.	
front bezel for buzzer 30 - 55 mm	IP 40	plastic	grey	200-5000-00	200-9000-00	0,002
			black	200-6000-00	200-0000-00	0,002



front bezel-set for flush mounting

to us as IP 40: cut off (with knife) the anti-twisting at the front bezel/actuator

	degree of protection	material	colour	 18 x 24 mm Typ-Nr.	 18 x 18 mm Typ-Nr.	18 mm dia. Typ-Nr.	
front bezel-set for flush mounting 24 x 24 mm	IP 40/IP 65	plastic	black		200-4400-V0		0,007
24 x 30 mm	IP 40/IP 65	plastic	black	200-6400-V0			0,008
25 mm dia.	IP 40/IP 65	plastic	black			200-8400-V0	0,006

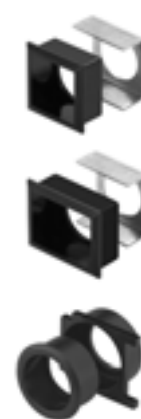

front bezel set for flush mounting for buzzer

to us as IP 40: cut off (with knife) the anti-twisting at the front bezel/actuator

	degree of protection	material	colour	 18 x 24 mm Typ-Nr.	
front bezel set for flush mounting for buzzer 24 x 30 mm	IP 40	plastic	black	200-6400-V0	0,008



protective cover for 35 mm

for pushbuttons 35 mm

	degree of protection	 18 x 24 mm Typ-Nr.	 18 x 18 mm Typ-Nr.	technical drawing	
protective cover for 35 mm hinged, transparent, with means for sealing	IP 40	200-6008-00	200-4008-00	58	0,002
	IP 65	200-6008-W0	200-4008-W0	58	0,002



technical drawings from page 642

protective cover for illuminated-/pushbutton 55 - 70 mm

	degree of protection	18 x 24 mm Typ-Nr.	18 x 18 mm Typ-Nr.	24 x 24 mm Typ-Nr.	technical drawing	
protective cover for illuminated-/pushbutton 55 - 70 mm hinged, transparent, not with means for sealing, for use as IP 40: cut off (with knife) the anti-twisting at the front bezel/actuator	IP 40/IP 65			200-0008-W0	58	0,006
hinged, transparent, with means for sealing	IP 40	200-6008-00	200-4008-00		58	0,005



technical drawings from page 642

protective cover for flush mounting

to us as IP 40: cut off (with knife) the anti-twisting at the front bezel/actuator

	degree of protection	use	material	colour	18 x 24 mm Typ-Nr.	18 x 18 mm Typ-Nr.	
protective cover for flush mounting 24x24 mm, hinged, transparent, with means for sealing	IP 40/IP65	for illuminated pushbutton/keylock switch	plastic	black		200-4408-V0	0,006
24x30 mm, hinged, transparent, with means for sealing	IP 40/IP65	for illuminated pushbutton/keylock switch	plastic	black	200-6408-V0		0,006



sprayproof cover

	material	18 x 24 mm Typ-Nr.	18 x 18 mm Typ-Nr.	
sprayproof cover 24x24 mm, two-part, protection IP 65, illumination exchangeable from the front	PVC		200-3009-W0	0,003
24x30 mm, two-part, protection IP 65, illumination exchangeable from the front	silicone	200-5009-W0		0,003



protective guard for illuminated-/pushbutton

for mounting depth 55/70 mm

	18 x 24 mm Typ-Nr.	18 x 18 mm Typ-Nr.	18 mm dia. Typ-Nr.	
protective guard for illuminated-/pushbutton aluminium anodized colourless, 18x20 mm		200-3007-00		0,002
aluminium anodized colourless, 20x24 mm	200-5007-00			0,002
aluminium anodized colourless, 20 mm dia.			200-1007-00	0,002



pressure ring

for indicator IP 65, mounting depth 30/45 mm, obligatory

	part no.	
pressure ring plastic suitable for 24 dia. mm and 24 x 24 mm	200-8009-W0	0,001



sealing ring

for front bezel IP 65, 24 dia. mm and 24 x 24 mm

	degree of protection	material	part no.	
sealing ring	IP 65	silicone	200-9009-W0	0,001



sealing bulb



for lens IP65, 24 dia. mm and 24 x 24 mm

	degree of protection	material	part no.	
sealing bulb	IP 65	silicone	200-7009-W0	0,001



blind plug for 35 mm

for lenses and pushbuttons 35 mm

	degree of protection	colour	 18 x 24 mm Typ-Nr.	 18 x 18 mm Typ-Nr.	18 mm dia. Typ-Nr.	
blind plug for 35 mm for mounting hole 16.2 mm dia.	IP 40	grey	200-5006-00	200-3006-00	200-1006-00	0,003
		black	200-6006-00	200-4006-00	200-2006-00	0,003
	IP 65	black	200-6006-W0	200-4006-W0	200-2006-W0	0,003



blind plug

for lenses and pushbuttons 30/45/55/70 mm

	degree of protection	colour	∅ 18 x 24 mm Typ-Nr.	∅ 18 x 18 mm Typ-Nr.	18 mm dia. Typ-Nr.	∅ 24 x 24 mm Typ-Nr.	
blind plug for mounting hole 16.2 mm dia.	IP 40	grey	200-5006-00	200-3006-00	200-1006-00		0,003
		black	200-6006-00	200-4006-00	200-2006-00		0,003
	IP 65	black	200-6006-W0	200-4006-W0	200-2006-W0	200-0006-W0	0,003



spare key

add to the part no., the engraved lock no.

	use	part no.	
spare key for standard lock 1001	for emergency stop switch foolproof with key to release	240-4001-00	0,005
for standard lock B2 300, other lock numbers on request	for keylock switch	240-2001-00	0,005
for standard lock B2 390, other lock numbers on request	for emergency stop switch with key to release	240-3001-00	0,005



At ordering indicate marked lock no.

at back

snap-action switching element block for 35 mm

for pushbuttons 35 mm

	contacts	connection method	part no.	circuit drawing	component layout	
snap-action switching element block for 35 mm	1 NC + 1 NO	-	601-0000-00	56		0,006
		P	601-0000-0P	56	1	0,006
	1 NC + 1 NO + 1	-	608-0000-00	58		0,006
		P	608-0000-0P	58	1	0,006
	1 NC + 1 NO + 2	-	609-0000-00	59		0,006
		P	609-0000-0P	59	1	0,006
	2 NC + 2 NO	-	602-0000-00	57		0,006
		P	602-0000-0P	57	1	0,006



circuit drawings from page 657, component layouts from page 657

lamp element block for 35 mm

for indicator 35 mm

	diodes	connection method	part no.	circuit drawing	component layout	
lamp element block for 35 mm	0	-	600-0000-00	1		0,005
		P	600-0000-0P	1	1	0,005
	1	-	606-0000-00	60		0,006
		P	606-0000-0P	60	1	0,006
	2	-	607-0000-00	61		0,006
		P	607-0000-0P	61	1	0,006



circuit drawings from page 657, component layouts from page 657

blind element

	part no.	
blind element white	202-0600-00	0,002



lamp terminal

	use	part no.	
lamp terminal	for soldering-/plug-in terminal	270-0000-00	0,001
	for PCB terminal	270-0000-0P	0,001



intermediate section

	use	part no.	
intermediate section incl. fixing nut	for illuminated pushbutton 55 mm MG T 1 3/4	260-9000-00	0,005
	for illuminated pushbutton 70 mm T 5.5	260-8000-00	0,008



snap-action switching element

	contacts	colour	connection method	material of contacts	part no.	technical drawing	
snap-action switching element	1 NC + 1 NO	blue	-	gold plated	201-0500-00	59	0,003
		grey	-	gold plated	201-0800-00	59	0,003
			P	gold plated	221-0800-0P	59	0,003
		green	-	gold plated	201-0400-00	59	0,003



technical drawings from page 642

holder for 2 switching elements

	use	material	part no.	
holder for 2 switching elements	push-pull illuminated switch	plastic	270-2000-00	0,001
	for pushbutton 35 mm, keylock-/selector switch 45 mm	plastic	270-3000-00	0,001



holder for 3 switching elements

	use	material	part no.	
holder for 3 switching elements	for illuminated-/pushbuttons 55-70 mm	stainless steel	270-1000-00	0,001



spring with pin

for maintained version at the intermediate section

	use	part no.	
spring with pin	for illuminated pushbutton 55/70 mm	260-0010-00	0,001



PCB plug-in base

	for	pin orientation	part no.	
PCB plug-in base lamp terminal 0.5 mikron Au incl. lamp terminal 0.5 mikron Au	indicator 35/55/70 mm	angled	280-0200-00	0,006
		straight	280-0100-00	0,005
	1NC + 1NO for 35/45 mm	angled	280-1210-00	0,006
		straight	280-1110-00	0,005
	1NC + 1NO for 55/70 mm	angled	280-1200-00	0,006
		straight	280-1100-00	0,005
	2NC + 2NO for 35/45/55/70 mm	angled	280-2200-00	0,006
		straight	280-2100-00	0,005
	3NC + 3NO for 55/70 mm	angled	280-3200-00	0,006
		straight	280-3100-00	0,005



multi-plug housing

	part no.	
multi-plug housing for flat connector with locating tongue with 14 terminal possibilities, 10 terminals plugable max.	280-0000-00	0,002



cable shoe

	use	locating tongue	wire cross-section of terminal	connection method	part no.	
cable shoe	for multi-plug housing (280-0000-00)	with	0.1 - 0.25 mm&	- 2.8 x 0.5 mm	280-0001-00	0,001
			0.5 - 1.00 mm&	- 2.8 x 0.5 mm	280-0002-00	0,001
as per VDE 0630 use with insulation socket (280-0010-00)	for insulation socket (280-0010-00)	without	0.2 - 0.75 mm&	- 2.8 x 0.5 mm	280-0003-00	0,001



connector with two outputs

	use	connection method	part no.	
connector with two outputs	for cable shoe (280-0003-00)	- 2.8 x 0.5 mm	280-0004-00	0,001



insulation socket

	part no.	
insulation socket for connector without locating tongue (280-0003-00)	280-0010-00	0,001



for illumination

filament lamp MG T 1 3/4

	voltage/current	part no.	
filament lamp MG T 1 3/4	14 V / 80 mA	10-1310.1319	0,001
	28 V / 40 mA	10-1313.1249	0,001
	36 V / 30 mA	10-1316.1209	0,001
	48 V / 25 mA	10-1319.1199	0,001
	6.3 V / 200 mA	10-1307.1369	0,001
	60 V / 20 mA	10-1320.1179	0,001



filament lamp T 5.5

	voltage/current	part no.	
filament lamp T 5.5	6 V / 200 mA	10-1106.1369	0,001
	12 V / 100 mA	10-1109.1329	0,001
	24 V / 50 mA	10-1112.1279	0,001
	36 V / 35 mA	10-1116.1229	0,001
	48 V / 25 mA	10-1119.1199	0,001



LED MG T 1 3/4

	number of chips	voltage/current	colour	part no.	
LED MG T 1 3/4 with built-in protective diode	6	6 VDC / 45 mA	yellow	10-5306.3254	0,001
			green	10-5306.3255	0,001
			red	10-5306.3252	0,001
		12 VDC / 25 mA	yellow	10-5309.3204	0,001
			green	10-5309.3205	0,001
			red	10-5309.3202	0,001
		24 VDC / 12.5 mA	yellow	10-5312.3134	0,001
			green	10-5312.3135	0,001
			red	10-5312.3132	0,001
		48 VDC / 12.5 mA	yellow	10-5319.3104	0,001
			green	10-5319.3105	0,001
			red	10-5319.3102	0,001



Note:
For optimal illumination we strongly recommend using our new single-chip LEDs.

For new designs, only the new single-chip LEDs should be chosen. They can be found on page 669.

LED T 5.5

	number of chips	voltage/current	colour	part no.	
LED T 5.5 with built-in protective diode Note: For optimal illumination we strongly recommend using our new single-chip LEDs. For new designs, only the new single-chip LEDs should be chosen. They can be found on page 669.	6	6 VDC / 45 mA	yellow	10-5106.3254	0,001
			green	10-5106.3255	0,001
			red	10-5106.3252	0,001
		12 VDC / 25 mA	yellow	10-5109.3204	0,001
			green	10-5109.3205	0,001
			red	10-5109.3202	0,001
		24 VDC / 12.5 mA	yellow	10-5112.3144	0,001
			green	10-5112.3145	0,001
			red	10-5112.3142	0,001
		48 VDC / 12.5 mA	yellow	10-5119.3134	0,001
			green	10-5119.3135	0,001
			red	10-5119.3132	0,001



diode element

	diodes	colour	connection method	part no.	
diode element diode 1N/4007	1	red	-	212-0100-00	0,003
			P	222-0100-0P	0,003
	2	red	-	213-0100-00	0,003
			P	214-0100-0P	0,003



capacitor

for lamp voltage reduction

	value	part no.	
capacitor use with 60 V/20 mA, 50 Hz lamp voltage	220 V/0.27 µF	300-0090-00	0,004



Please keep to the country specific security rules.

series resistor

for lamp voltage reduction

	value	part no.	
series resistor use with 60 V / 20 mA lamp rating	100 V / 2.7 kΩ	300-0010-00	0,003
	125 V / 3.3 kΩ	300-0020-00	0,003
	145 V / 4.7 kΩ	300-0030-00	0,003
	230 V / 8.2 kΩ	300-0040-00	0,003
	240 V / 10 kΩ	300-0050-00	0,003



Please keep to the country specific security rules.

terminal plate empty

for fitting with series resistors and capacitors

	no. of spaces	part no.	
terminal plate empty 125 x 60 x 15 mm	10 spaces	300-0110-00	0,045
187.5 x 60 x 15 mm	15 spaces	300-0115-00	0,090
250 x 60 x 15 mm	20 spaces	300-0120-00	0,095
62.5 x 60 x 15 mm	5 spaces	300-0105-00	0,025



for emergency stop switch

label for emergency stop switch

	degree of protection	marking	43 mm dia. Typ-Nr.	
label for emergency stop switch yellow, other constructions on request	IP 40	in German	200-1300-02	0,002
		in English	200-1300-03	0,002
		in French	200-1300-04	0,002
		without	200-1300-01	0,002
	IP 65	in German	200-1300-W2	0,002
		in English	200-1300-W3	0,002
		in French	200-1300-W4	0,002
		without	200-1300-W1	0,002



slow-make switching element for emergency stop switch

	contacts	colour	connection method	material of contacts	part no.	technical drawing	
slow-make switching element for emergency stop switch	1 NC	grey	-	gold plated	211+0800-00	60	0,003
			P	gold plated	231+0800-0P	60	0,003



technical drawings from page 642

dismantling tool for emergency stop switch foolproof

	part no.	
dismantling tool for emergency stop switch foolproof	300-0017-00	0,004



assembling

fixing nut

for standard mounting

	use	panel thickness	colour	part no.	
fixing nut plastic	for mounting depth 30-70 mm	1-3 mm	grey	260-0001-00	0,001
		3-5 mm	grey	260-0002-00	0,001
		5-7 mm	grey	260-0005-00	0,001
	for mounting depth 35 mm	1-3 mm	black	260-0003-00	0,001



fixing nut for flush mounting

	use	panel thickness	colour	part no.	
fixing nut for flush mounting plastic	for mounting depth 41/44 mm	1-3 mm	black	260-0003-00	0,001
	for mounting depth 39-79 mm	3-5 mm	grey	260-0002-00	0,001



location strip

for indicators, illuminated/push buttons, push-pull illuminated button, buzzer, mushroom-head cap, key and selector switches and emergency button 55-70 mm IP 40 / IP 65 designs

	use	part no.	
location strip anti-twisting, in-line arrays or single switches	graduation 18 mm	260-0020-00	0,001
	graduation 24 mm	260-0021-00	0,001



lens remover

	part no.	
lens remover	300-0001-00	0,012



lamp/LED remover

	part no.	
lamp/LED remover	300-0002-00	0,003

Warning:
when replacing lamps/LED a switching process can be triggered!



mounting tool

	part no.	
mounting tool for tightening (or loosening) fixing nuts (at dismantled element block)	300-0003-00	0,007



contact element pliers

for block mounting

	part no.	
contact element pliers for dismantling the switching elements off the holder for 3 switching elements	300-0005-00	0,013



jaw spanner

	part no.	
jaw spanner for tightening (or loosening) fixing nuts and dismantling of the element blocks (mounting depth 35-70 mm)	300-0004-00	0,003



cable shoe remover

	part no.	
cable shoe remover for removing the connector from the multi-plug housing (280-0000-00)	300-0006-00	0,001



Switching system

Self-cleaning, double-break slow-make element with four-path contacts (contact opening width 2 x 1.5 mm). The slow-make elements are constructed as per DIN EN 60947-5-1.

Materials

Mushroom-head cap

Polyamide PA

Actuator housing

Polyetherimide PEI, self-extinguishing

Switching element

Polyamide PA
Polysulfone PSU

Contact material

Silver

Connections

Solder/plug-in terminal

max. wire diameter: 2 wires of 1 mm
max. wire cross-section: 1 strand at 0.75 mm²

Connection

2.8 x 0.5 mm

Mechanical characteristic values

Actuating travel

EMERGENCY button 10 mm

Actuating force

max. 65 N (measured on mushroom-head cap of emergency button)

Self-aligning torque

15 Ncm

Shock resistance

(single impact, half-sinusoidal)
50 g, 11 ms as per IEC 512-4

Resistance to vibration

(sinusoidal)
10 g, at 10- 2000- 10- Hz
Amplitude 0.75 mm as per IEC 512-4

Rebound time

<= 2 ms

Degree of pollution

3

Protection class

Front side IP 65
Switching element IP 40

Ambient temperature

-25°C as per DIN EN 60068-2-1
+55°C as per DIN EN 60068-2-2

Storage temperature

-40°C to +85°C

Mechanical service life

EMERGENCY button 50,000 operations

Electrical characteristic values

Switch rating

Silver contact
(Solder/plug-inmin. 20 VAC, 10 mA
connection)max. 250 VAC, 5 A

Service category

Rated service voltage	Rated service current (inductive)	
	AC 13	AC 14
250 VAC	3 A	2 A
120 VAC	5 A	3 A
60 VAC	6 A	4 A
24 VAC	6 A	5 A

Service category

Rated service voltage	Rated service current	
	resistive	DC 13
240 VDC	0.5 A	0.2 A
110 VDC	0.7 A	0.4 A
60 VDC	2.0 A	1.0 A
24 VDC	6.0 A	2.0 A

Volume resistivity

New value for:
Silver contact
<= 50 m Ω
as per IEC 512-2 Test 5

Rated insulation voltage Ui

300 VAC

Electric strength

as per VDE 0660 (IEC 512-2-11)
4000 VAC, 50 Hz, 1 min between connections and earth

Overvoltage category

III

Thermal steady current

I_{th2} solder/plug-in connection 5 A

Max. permissible current for continuous operation and ambient temperature which does not exceed the specified max. values

Max. permissible rated current

for series-connected blow-out fuse
10 A gL

Electrical service life

Slow-make element 6050 operations

Approvals

- CE (declaration of conformity)
- CSA
- UR
- VDE
- ENEC

Right reserved to change all technical specifications.

EMERGENCY slow-make element

General

Is equipped with rigid contact link. The slow-make element opens positively and simply consists of a double-break NC. The multilayer contacts are designed for universal use and are gilded with a 2 μ m gold coating. The EMERGENCY slow-make element is designed according to DIN EN 60947-5-1.

Material

Housing

Duroplast (DAP)
with fireproofing as per UL 94 V0

Contact

AgNi, 2 μ m gilded

Contact carrier

Brass or CuBe

Connection

Brass gilded
2.8 x 0.5 mm solder/plug-in or PCB connection
1 mm² max. connection cross-section

Mechanical characteristic values

Ambient temperature

-25°C as per DIN EN 60068-2-1
+55°C as per DIN EN 60068-2-2

Storage temperature

-40°C to +85°C

Mechanical service life

8000 switching cycles

Contact opening width

> 2 x 1.5 mm

EMERGENCY switching element

Electrical characteristic values

Rated voltage

250 V / 50 Hz

Service category

AC 15: 250 V / 1 A

Rated insulation voltage U_i

250 V

Series-connected blow-out fuse

5 A gL

Conventional thermal current I_{th}

5 A

Electrical service life

8000 switching cycles AC 15: 250 V / 1 A

Diode element

General

Has no switching function. The diodes are soldered into the switching element housing between the contact connections.

Material

Housing

Thermoplast (PETP)
with fireproofing as per UL 94 V0

Connection

Brass gilded
2.8 x 0.5 mm solder/plug-in or PCB connection
1 mm² max. connection cross-section

Electrical characteristic values

Diode

1 N / 4007, $I_{max.} = 1$ A, $U_{block} = 1000$ V

Dummy element

General

Is inserted in empty places in the switching element block. The dummy element has no metal parts and no electrical function.

Material

Housing

Thermoplast (PET)
with fireproofing as per UL 94 V0

Alarm buzzer

Operating voltage

Current consumption

approx. 13 mA

Reverse-connect protection

yes

Acoustics

approx. 84 dB at 0.1 m

Frequency

approx. 2.3 kHz

Unit

General

In accordance with the low-voltage directive, our products are labelled with the CE mark.

SWISSTAC switches are modularly designed and are divided into the following three groups:

1. Front

Man-switch interface and state detector

2. Intermediate piece

Set and reset device, bulb holder, latching function

3. Switching element block

Up to five switching elements can be integrated in a switching element block.

Each switch is tested fully mounted. Electrical output and service life are determined by the switching element. Front and intermediate piece are designed for maximum service life of the switching element. They determine in what way the switches are protected against external influences. The type approvals relate to the complete switches. The approval regulations are UL 1054, VDE 0630 (EMERGENCY button VDE 0660), CSA 22.2.

Mechanical characteristic values

Resistance to vibration

tested as per DIN EN 60068-2-6 (10 g to 2000 Hz)

Shock resistance

tested as per DIN EN 60068-2-27 (semi-sinusoidal, 50 g during 11 ms) (single impacts, semi-sinusoidal)
15 g during 11 ms as per DIN EN 60068-2-29

Approvals

- CE (declaration of conformity)
- CSA
- UR
- VDE
- ENEC

Front

General

The front notifies the switching status, serves for activation of the switch and determines its type of protection. The form and colours of the front also characterise the appearance of the entire switching system. With the exception of the front \varnothing 18 mm of the illuminated pushbuttons 55 and 70 mm, all front frame elements have activation protection.

Material

Lens

Thermoplast (PC)

Front bezel

Thermoplast with fireproofing (PBT)

Actuator 35 mm

Thermoplast with fireproofing (PBT)

Lock housing

Thermoplast with fireproofing (PBT)

Lock cylinder

Rynite reinforced with carbon fibre (PBT + CF)

Seal bellows (IP 65)

Silicon

Mechanical characteristic values

Protection class

as per IEC 529 (front side)

IP 40

IP 65

IP 67

protection against water

0 = without protection

5 = spray water

7 = watertight up to 1 m WS

protection against solid matter of varying size

4 = protection against solid matter $> \varnothing$ 1 mm

6 = dust-tight

see "Intermediate piece" for other properties

Intermediate piece

General

The intermediate piece serves for several properties such as the setting and resetting functions, and the latching device. In addition, all parts necessary for a complete switch are fastened to the intermediate piece. These include the front parts, switching element block and lamps.

Material

Housing

Thermoplast with fireproofing (PC)

Lamp connection

Nickel silver 2.8 x 0.5 mm

Electrical characteristic values

Electric strength

3750 V AC, 1 min. as per DIN EN 61058-1

Insulation resistance

$> 10^{12} \Omega$ as per IEC 512-2-10

Illumination

Lamp voltage

6 V to 125 V as per CSA

6 V to 60 V as per VDE, UL, DEMKO

Lamp output

max. 1.2 W

Mechanical characteristic values

Ambient temperature

-25°C as per DIN EN 60068-2-1

+55°C as per DIN EN 60068-2-2

Storage temperature

-40°C to +85°C

Service life

> 2 x 10⁶ activations of the illuminated pushbuttons

> 5 x 10⁴ activations of the key and selector switches

> 8 x 10³ activations of the emergency button

> 2.5 x 10⁵ activations of the push-pull illuminated button

Switching element block

General

Up to five independent switching elements can be integrated in the switching element block as a switching unit. There are four different types of switching element available.

1. Snap-action switching element
2. Emergency button switching element
3. Diode element
4. Dummy element

Material

Bracket for three switching elements

rust-free chromium steel

Bracket for two switching elements

Thermoplast with fireproofing (PA6)

Lamp connection

CuBe, 2 µm Optalloy 2.8 x 0.5 mm solder/plug-in connection

Electrical characteristic values

Electric strength

2000 V AC, 50 Hz 1 min. (functional isolation)

Insulation resistance

> 10¹² W

In accordance with the VDE 0630 regulation, blade receptacles must be used with the insulation socket 280-0010-00.

Snap-action switching element

General

Is equipped with double-break jump contacts. Owing to the large cleaning path, outstanding self-cleaning is possible. The multilayer contacts are designed for universal use. They are gilded with a 2 µm gold coating. Each snap-action switching element comprises an NC (normally closed contact) and an NO (normally open contact)

Material

Housing

Thermoplast (PETP)
with fireproofing as per UL 94 V0

Contact

AgNi, 2 µm gilded

Contact carrier

Brass or CuBe

Connection

Brass gilded

2.8 x 0.5 mm solder/plug-in or PCB connection

1 mm² max. connection cross-section

Mechanical characteristic values

Ambient temperature

-25°C to +55°C

-25°C as per DIN EN 60068-2-1

+55°C as per DIN EN 60068-2-2

Storage temperature

-40°C to +85°C as per DIN EN 60068

Mechanical service life

2 x 10⁵ switching cycles

Contact opening width

2 x 0.65 mm

Contact cleaning path

2 x 0.6 mm

Rebound time

typically 0.5 ms

Activation force

approx. 2 N for each snap-action switching element

Electrical characteristic values

Thermal steady current I_{th} max.

6 A, up to 3-pole switching element block

4 A, for 4- and 5-pole switching element blocks

Limited on thermal grounds to I_{max} = 4 A

Volume resistivity

<= 50 m Ω typically, new statically

Electrical load as per DIN EN 61058-1

5(1.5) A 250 V up to 3 switching elements

4(1) A 250 V for 4 or 5 switching elements,

min. AC / DC: 5 V / 1 mA

Electrical service life

> 10⁴ switching operations

DIN EN 61058-1250 V, (1.5) A

DIN EN 60947-5-1 AC 12:250 V / 0.5 A

110 V / 2 A

75 V / 5 A

60 V / 6 A

48 V / 6 A

24 V / 6 A

Snap-action switching element

Out 4.7

In 3.6

technical drawings

1 indicator actuator 35 mm, pushbutton-/illuminated pushbutton actuator 35 mm
page 591, 592



2 indicator 30 - 70 mm, buzzer 30 - 55 mm
page 591, 607



3 indicator 30 - 70 mm
page 591



4 indicator 30 - 70 mm, buzzer 30 - 55 mm
page 591, 607



5 indicator 30 - 70 mm, buzzer 30 - 55 mm
page 591, 607



6 indicator 30 - 70 mm
page 591



7 indicator 30 - 70 mm

page 591



8 illuminated-/pushbutton 55 - 70 mm

page 593



9 illuminated-/pushbutton 55 - 70 mm

page 593



10 illuminated-/pushbutton 55 - 70 mm

page 593



11 illuminated-/pushbutton 55 - 70 mm

page 593

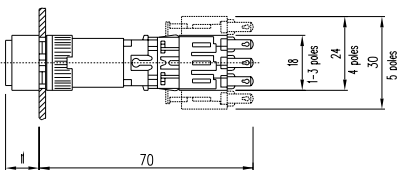

12 emergency stop switch 55 - 70 mm

page 594

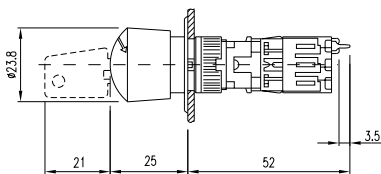

13 emergency stop switch 55 - 70 mm

page 594

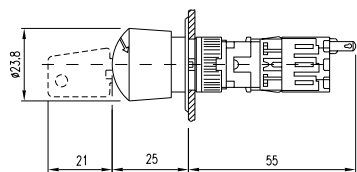

14 emergency stop switch 55 - 70 mm

page 594

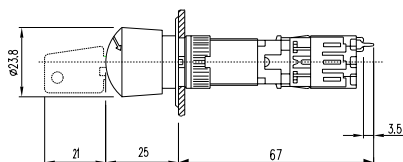

15 emergency stop switch 55 - 70 mm

page 594

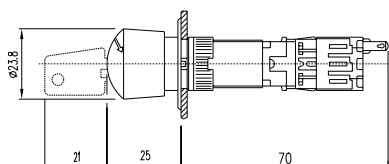

16 emergency stop switch foolproof 41 mm

page 596

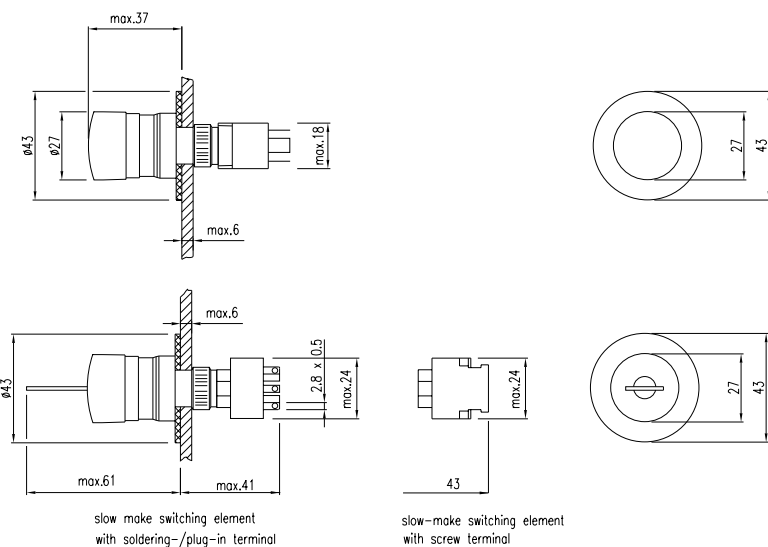

17 pushbutton with mushroom-head cap 55 - 70 mm

page 597

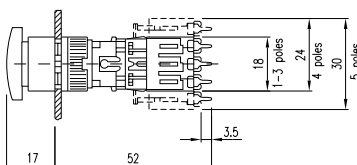

18 pushbutton with mushroom-head cap 55 - 70 mm
page 597

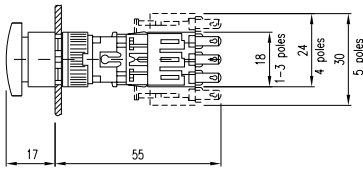

19 pushbutton with mushroom-head cap 55 - 70 mm
page 597

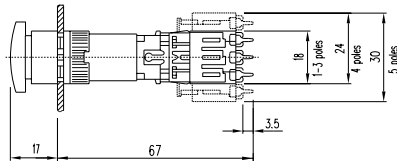

20 pushbutton with mushroom-head cap 55 - 70 mm
page 597

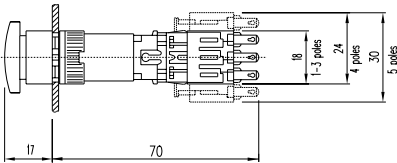

21 keylock switch 2 positions 45 - 70 mm, keylock switch 3 positions 45 mm
page 598, 602

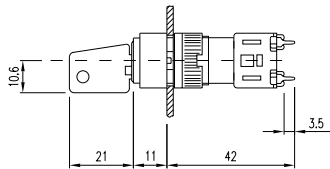

22 keylock switch 2 positions 45 - 70 mm, keylock switch 3 positions 45 mm
page 598, 602

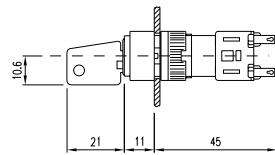

23 keylock switch 2 positions 45 - 70 mm
page 598

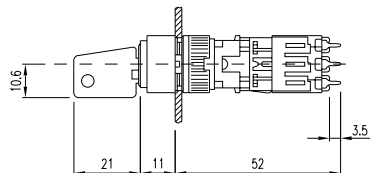

24 keylock switch 2 positions 45 - 70 mm
page 598

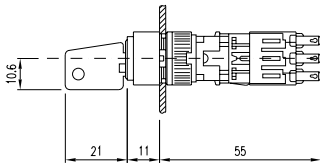

25 keylock switch 2 positions 45 - 70 mm
page 598

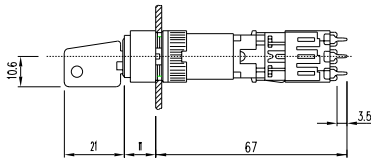

26 keylock switch 2 positions 45 - 70 mm
page 598

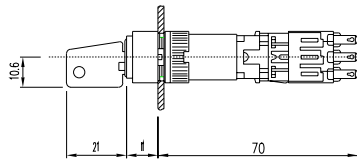

27 selector switch 2 positions 45 - 70 mm, selector switch 3 positions 45 mm
page 603, 606

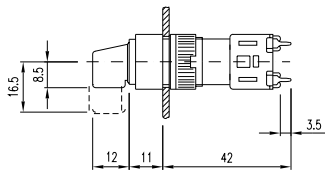

28 selector switch 2 positions 45 - 70 mm, selector switch 3 positions 45 mm
page 603, 606

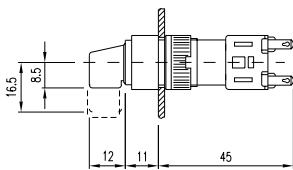

29 selector switch 2 positions 45 - 70 mm
page 603

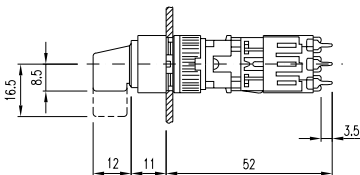

30 selector switch 2 positions 45 - 70 mm
page 603



31 selector switch 2 positions 45 - 70 mm
page 603



32 selector switch 2 positions 45 - 70 mm
page 603



33 push-pull illuminated switch 45 mm
page 607

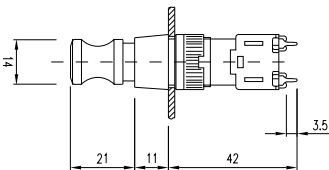

34 push-pull illuminated switch 45 mm
page 607

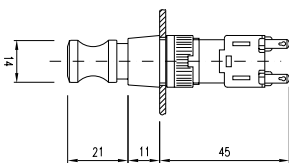

35 indicator actuator 41-44 mm for flush mounting, illuminated-/pushbutton actuator 41-44 mm for flush mounting
page 608, 610



36 indicator for flush mounting 39 - 79 mm, buzzer for flush mounting 39 - 64 mm
page 609, 621

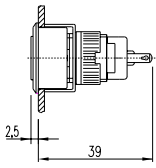

37 indicator for flush mounting 39 - 79 mm
page 609

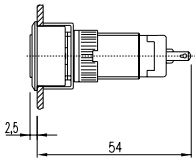

38 indicator for flush mounting 39 - 79 mm, buzzer for flush mounting 39 - 64 mm
page 609, 621

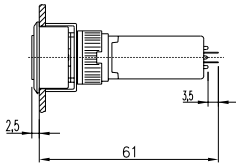

39 indicator for flush mounting 39 - 79 mm, buzzer for flush mounting 39 - 64 mm
page 609, 621

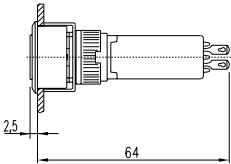

40 indicator for flush mounting 39 - 79 mm
page 609

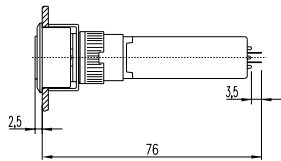

41 indicator for flush mounting 39 - 79 mm
page 609

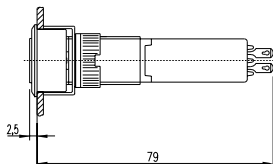

42 pushbutton-/illuminated pushbutton for flush mounting 61 - 79 mm
page 611

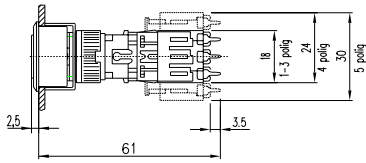

43 pushbutton-/illuminated pushbutton for flush mounting 61 - 79 mm
page 611

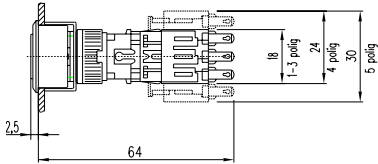

44 pushbutton-/illuminated pushbutton for flush mounting 61 - 79 mm
page 611

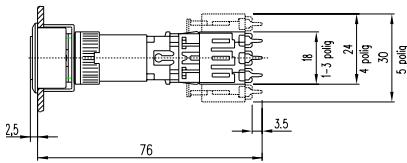

45 pushbutton-/illuminated pushbutton for flush mounting 61 - 79 mm
page 611

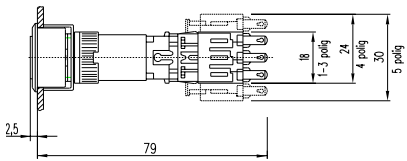

46 keylock switch 2 positions for flush mounting 51 - 79 mm, keylock switch with 3 positions for flush mounting 51 - 54 mm
page 612, 616

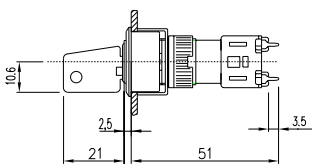

47 keylock switch 2 positions for flush mounting 51 - 79 mm, keylock switch with 3 positions for flush mounting 51 - 54 mm
page 612, 616

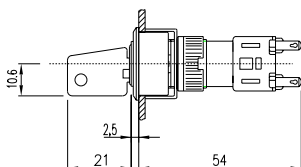

48 keylock switch 2 positions for flush mounting 51 - 79 mm
page 612



49 keylock switch 2 positions for flush mounting 51 - 79 mm
page 612



50 keylock switch 2 positions for flush mounting 51 - 79 mm
page 612



51 keylock switch 2 positions for flush mounting 51 - 79 mm
page 612

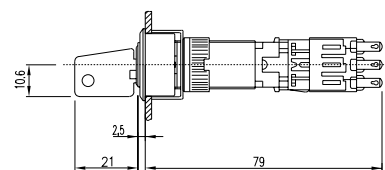

52 selector switch 2 positions for flush mounting 51 - 79 mm, selector switch 3 positions for flush mounting 51 - 54 mm
page 617, 620



53 selector switch 2 positions for flush mounting 51 - 79 mm, selector switch 3 positions for flush mounting 51 - 54 mm
page 617, 620



54 selector switch 2 positions for flush mounting 51 - 79 mm
page 617



55 selector switch 2 positions for flush mounting 51 - 79 mm
page 617



56 selector switch 2 positions for flush mounting 51 - 79 mm
page 617

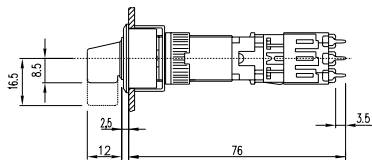

57 selector switch 2 positions for flush mounting 51 - 79 mm
page 617



58 protective cover for 35 mm, protective cover for illuminated-/pushbutton 55 - 70 mm
page 628, 629



59 snap-action switching element

page 632



60 slow-make switching element for emergency stop switch

page 636



mounting dimensions

1 indicator actuator 35 mm, pushbutton-/illuminated pushbutton actuator 35 mm

page 591, 592

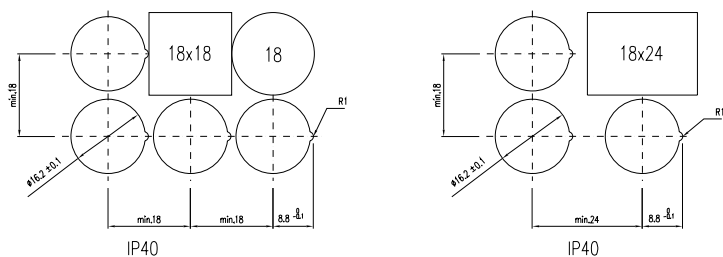

2 indicator actuator 35 mm, pushbutton-/illuminated pushbutton actuator 35 mm

page 591, 592

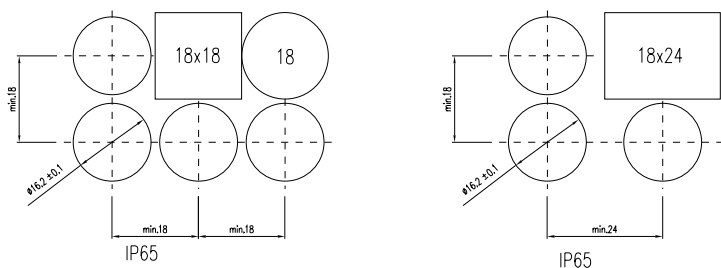

3 indicator 30 - 70 mm, illuminated-/pushbutton 55 - 70 mm
page 591, 593,



4 emergency stop switch 55 - 70 mm
page 594



5 emergency stop switch 55 - 70 mm
page 594



6 emergency stop switch foolproof 41 mm
page 596



7 pushbutton with mushroom-head cap 55 - 70 mm

page 597

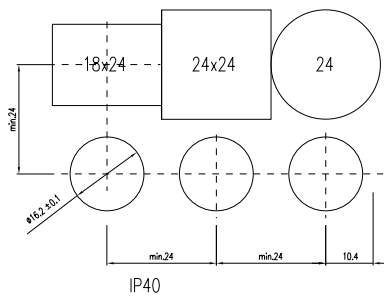

8 keylock switch 2 positions 45 - 70 mm, keylock switch 3 positions 45 mm

598, 602,

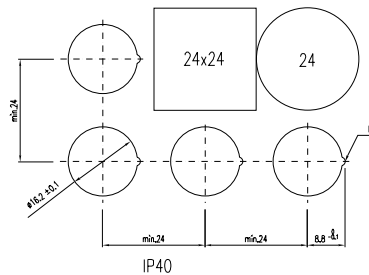
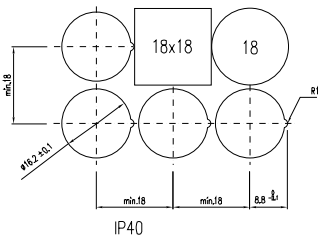

9 keylock switch 2 positions 45 - 70 mm, keylock switch 3 positions 45 mm

page 598, 602

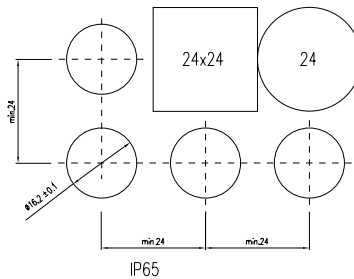
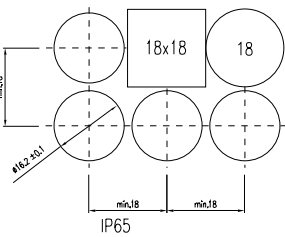

10 selector switch 2 positions 45 - 70 mm, selector switch 3 positions 45 mm

page 603, 606

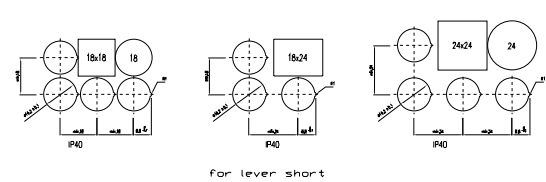
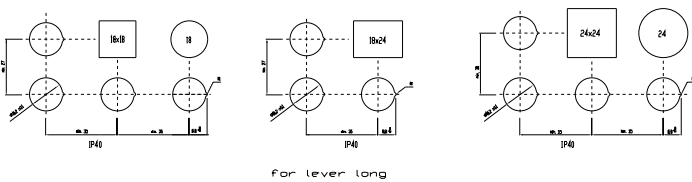

11 selector switch 2 positions 45 - 70 mm, selector switch 3 positions 45 mm

page 603, 606

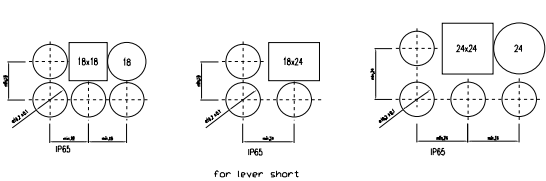
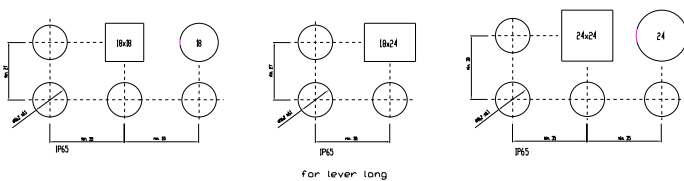

12 buzzer 30 - 55 mm

page 607



13 push-pull illuminated switch 45 mm

page 607



14 indicator actuator 41-44 mm for flush mounting, indicator for flush mounting 39 - 79 mm, illuminated-/pushbutton actuator 41-44 mm for flush mounting, pushbutton-/illuminated pushbutton for flush mounting 61 - 79 mm, keylock switch with 3 positions for flush mounting 51 - 54 mm
page 608, 609, 610, 611, 612, 616

$\varnothing 25\text{mm}$

24 x 30mm

24 x 24mm



15 selector switch 2 positions for flush mounting 51 - 79 mm, selector switch 3 positions for flush mounting 51 - 54 mm
page 617, 620

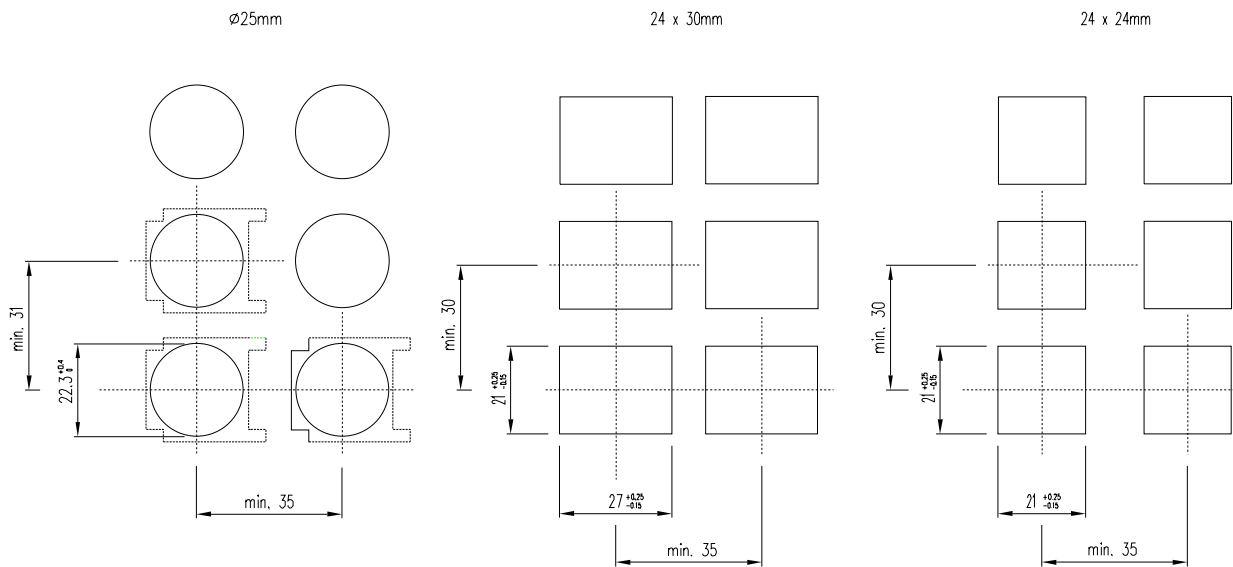

16 buzzer for flush mounting 39 - 64 mm
page 621

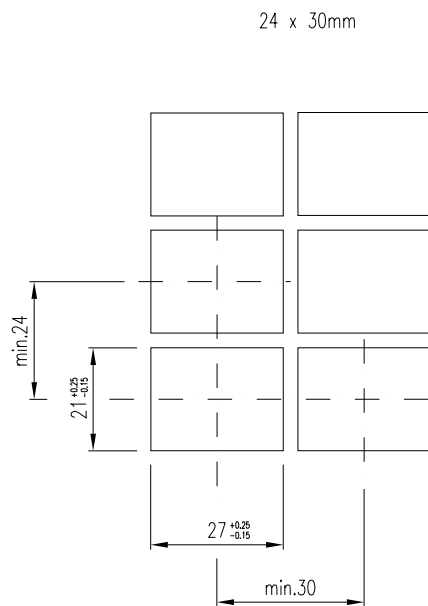

component layouts

1 indicator actuator 35 mm, indicator 30 - 70 mm, pushbutton-/illuminated pushbutton actuator 35 mm, illuminated-/pushbutton 55 - 70 mm, emergency stop switch 55 - 70 mm, pushbutton with mushroom-head cap 55 - 70 mm, keylock switch 2 positions 45 - 70 mm, keylock switch 3 positions 45 mm, selector switch 2 positions 45 - 70 mm, selector switch 3 positions 45 mm, buzzer 30 - 55 mm, push-pull illuminated switch 45 mm, indicator for flush mounting 39 - 79 mm, pushbutton-/illuminated pushbutton for flush mounting 61 - 79 mm, keylock switch 2 positions for flush mounting 51 - 79 mm, keylock switch with 3 positions for flush mounting 51 - 54 mm, selector switch 2 positions for flush mounting 51 - 79 mm, selector switch 3 positions for flush mounting 51 - 54 mm, buzzer for flush mounting 39 - 64 mm, snap-action switching element block for 35 mm, lamp element block for 35 mm

page 591, 591, 592, 593, 594, 597, 598, 602, 603, 606, 607, 607, 609, 611, 612, 616, 617, 620, 621, 631, 632

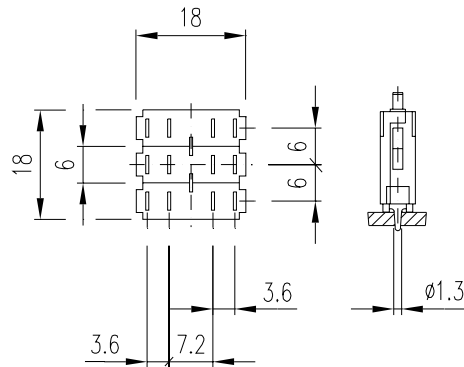

circuit drawings

1 indicator actuator 35 mm, indicator 30 - 70 mm, indicator actuator 41-44 mm for flush mounting, indicator for flush mounting 39 - 79 mm, lamp element block for 35 mm

page 591, 591, 608, 609, 632

x1+



x2-

2 pushbutton-/illuminated pushbutton actuator 35 mm

page 592

x1+

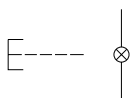

x2-

3 pushbutton-/illuminated pushbutton actuator 35 mm

page 59

x1+



x2-

4 illuminated-/pushbutton 55 - 70 mm, pushbutton-/illuminated pushbutton for flush mounting 61 - 79 mm
 593, 611,

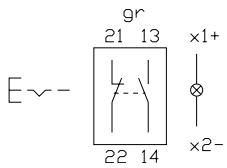

5 illuminated-/pushbutton 55 - 70 mm, pushbutton-/illuminated pushbutton for flush mounting 61 - 79 mm
 page 593, 611

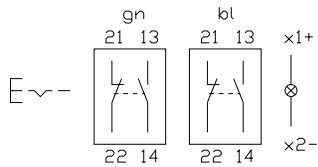

6 illuminated-/pushbutton 55 - 70 mm, pushbutton-/illuminated pushbutton for flush mounting 61 - 79 mm
 page 593, 611

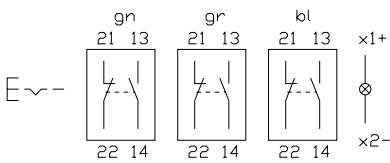

7 illuminated-/pushbutton 55 - 70 mm, pushbutton-/illuminated pushbutton for flush mounting 61 - 79 mm
 page 593, 611

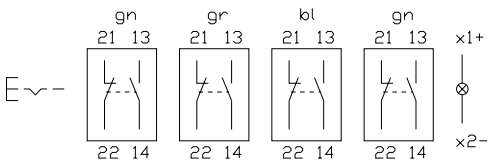

8 illuminated-/pushbutton 55 - 70 mm, pushbutton-/illuminated pushbutton for flush mounting 61 - 79 mm
 page 593, 611

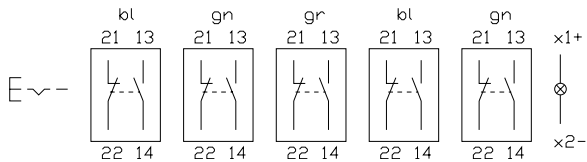

9 emergency stop switch 55 - 70 mm
 page 594

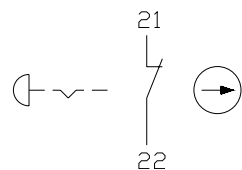

10 emergency stop switch 55 - 70 mm
 page 594

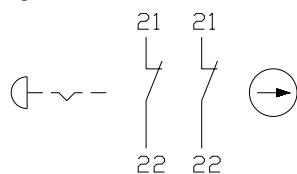

11 emergency stop switch 55 - 70 mm

page 594



12 emergency stop switch foolproof 41 mm

page 596



13 emergency stop switch foolproof 41 mm

page 596

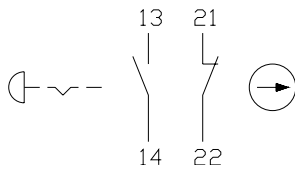

14 emergency stop switch foolproof 41 mm

page 596

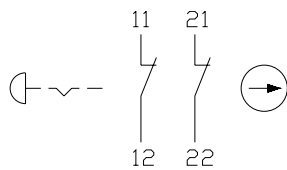

15 pushbutton with mushroom-head cap 55 - 70 mm

page 597

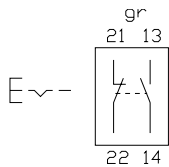

16 pushbutton with mushroom-head cap 55 - 70 mm

page 597

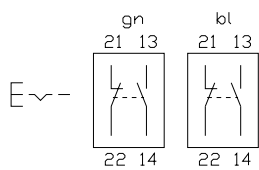

17 pushbutton with mushroom-head cap 55 - 70 mm

page 597

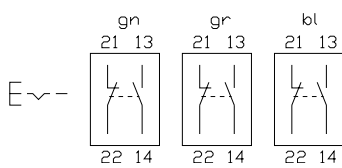

18 pushbutton with mushroom-head cap 55 - 70 mm

page 597



19 pushbutton with mushroom-head cap 55 - 70 mm

page 597



20 keylock switch 2 positions 45 - 70 mm, keylock switch 2 positions for flush mounting 51 - 79 mm

page 598, 612



21 keylock switch 2 positions 45 - 70 mm, keylock switch 2 positions for flush mounting 51 - 79 mm

page 598, 612



22 keylock switch 2 positions 45 - 70 mm, keylock switch 2 positions for flush mounting 51 - 79 mm

page 598, 612

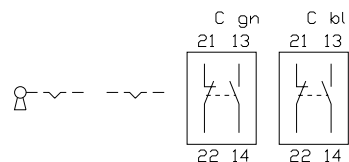

23 keylock switch 2 positions 45 - 70 mm, keylock switch 2 positions for flush mounting 51 - 79 mm

page 598, 612



24 keylock switch 2 positions 45 - 70 mm, keylock switch 2 positions for flush mounting 51 - 79 mm

page 598, 612



25 keylock switch 2 positions 45 - 70 mm, keylock switch 2 positions for flush mounting 51 - 79 mm
page 598, 612



26 keylock switch 2 positions 45 - 70 mm, keylock switch 2 positions for flush mounting 51 - 79 mm
page 598, 612



27 keylock switch 2 positions 45 - 70 mm, keylock switch 2 positions for flush mounting 51 - 79 mm
page 598, 612



28 keylock switch 2 positions 45 - 70 mm, keylock switch 2 positions for flush mounting 51 - 79 mm
page 598, 612



29 keylock switch 2 positions 45 - 70 mm, keylock switch 2 positions for flush mounting 51 - 79 mm
page 598, 612



30 keylock switch 2 positions 45 - 70 mm, keylock switch 2 positions for flush mounting 51 - 79 mm
page 598, 612



31 keylock switch 2 positions 45 - 70 mm, keylock switch 2 positions for flush mounting 51 - 79 mm
page 598, 612



32 keylock switch 3 positions 45 mm, keylock switch with 3 positions for flush mounting 51 - 54 mm

page 602, 616

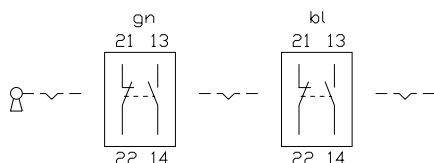

33 keylock switch 3 positions 45 mm, keylock switch with 3 positions for flush mounting 51 - 54 mm

page 602, 616

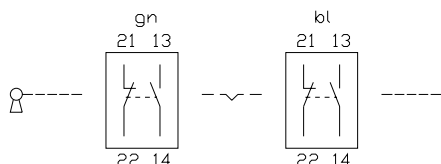

34 keylock switch 3 positions 45 mm, keylock switch with 3 positions for flush mounting 51 - 54 mm

page 602, 616

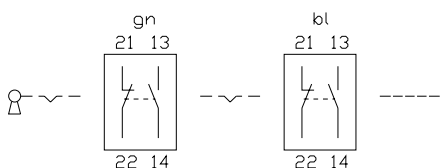

35 keylock switch 3 positions 45 mm, keylock switch with 3 positions for flush mounting 51 - 54 mm

page 602, 616

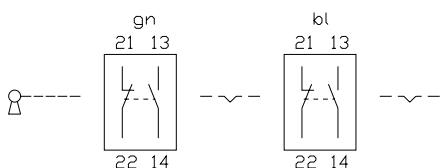

36 selector switch 2 positions 45 - 70 mm, selector switch 2 positions for flush mounting 51 - 79 mm

page 603, 617

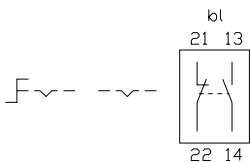

37 selector switch 2 positions 45 - 70 mm, selector switch 2 positions for flush mounting 51 - 79 mm

page 603, 617

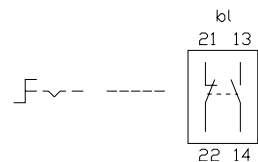

38 selector switch 2 positions 45 - 70 mm, selector switch 2 positions for flush mounting 51 - 79 mm

page 603, 617

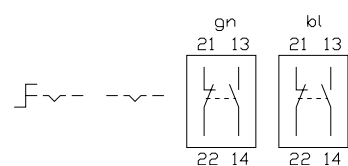

39 selector switch 2 positions 45 - 70 mm, selector switch 2 positions for flush mounting 51 - 79 mm
page 603, 617



40 selector switch 2 positions 45 - 70 mm, selector switch 2 positions for flush mounting 51 - 79 mm
page 603, 617

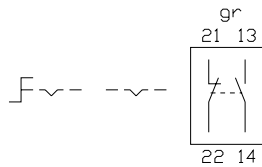

41 selector switch 2 positions 45 - 70 mm, selector switch 2 positions for flush mounting 51 - 79 mm
page 603, 617

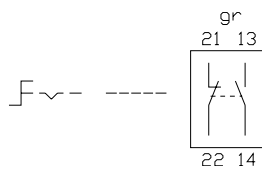

42 selector switch 2 positions 45 - 70 mm, selector switch 2 positions for flush mounting 51 - 79 mm
page 603, 617

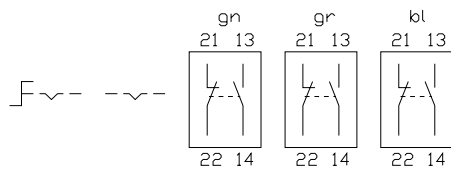

43 selector switch 2 positions 45 - 70 mm, selector switch 2 positions for flush mounting 51 - 79 mm
page 603, 617

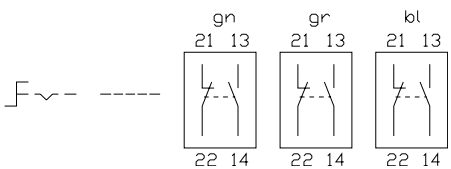

44 selector switch 2 positions 45 - 70 mm, selector switch 2 positions for flush mounting 51 - 79 mm
page 603, 617



45 selector switch 2 positions 45 - 70 mm, selector switch 2 positions for flush mounting 51 - 79 mm
page 603, 617

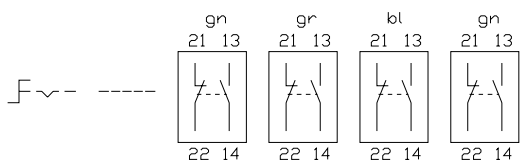

46 selector switch 2 positions 45 - 70 mm, selector switch 2 positions for flush mounting 51 - 79 mm
page 603, 617

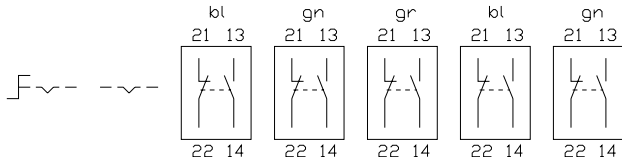

47 selector switch 2 positions 45 - 70 mm, selector switch 2 positions for flush mounting 51 - 79 mm
page 603, 617

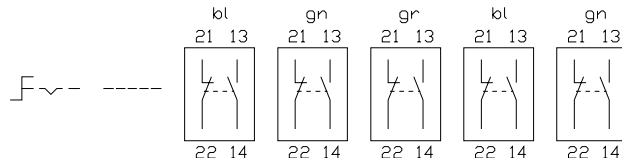

48 selector switch 3 positions 45 mm, selector switch 3 positions for flush mounting 51 - 54 mm
page 606, 620

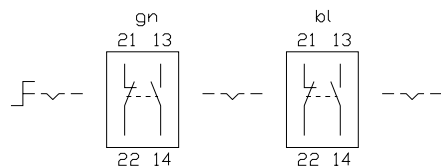

49 selector switch 3 positions 45 mm, selector switch 3 positions for flush mounting 51 - 54 mm
page 606, 620

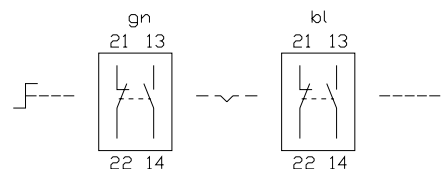

50 selector switch 3 positions 45 mm, selector switch 3 positions for flush mounting 51 - 54 mm
page 606, 620

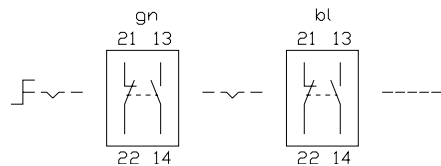

51 selector switch 3 positions 45 mm, selector switch 3 positions for flush mounting 51 - 54 mm
page 606, 620

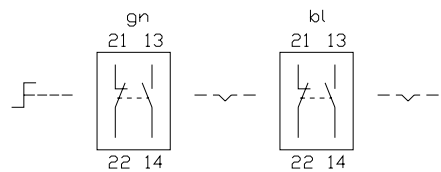

52 buzzer 30 - 55 mm, buzzer for flush mounting 39 - 64 mm
page 607, 621

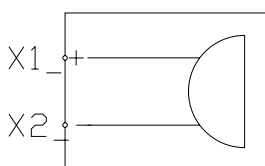

53 push-pull illuminated switch 45 mm

page 607



54 illuminated-/pushbutton actuator 41-44 mm for flush mounting

page 610

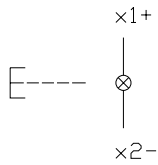

55 illuminated-/pushbutton actuator 41-44 mm for flush mounting

page 610

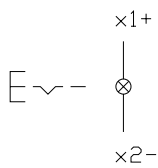

56 snap-action switching element block for 35 mm

page 631

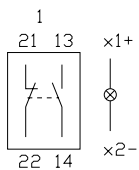

57 snap-action switching element block for 35 mm

page 631

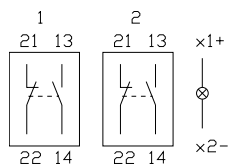

58 snap-action switching element block for 35 mm

page 631

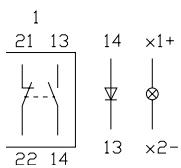

59 snap-action switching element block for 35 mm

page 631

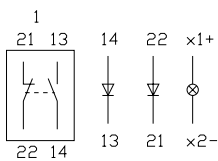

60 lamp element block for 35 mm

page 632

14 x1+

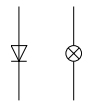

13 x2-

61 lamp element block for 35 mm

page 632

14 22 x1+

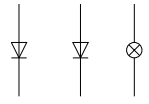

13 21 x2-

1. Engraving

The lens top or the lens holder can be engraved in any of the usual languages.
Typefaces: compressed typeface to DIN 1451. Other faces on request.

Colour of lettering

White for lens tops red, blue, green and black
Black for lens tops orange, yellow, grey and white
Black for lens holders translucent and transparent

Important!

With engraving, the position of the lens must agree with the position of the push-button or indicator.
However, the lens can be mounted turned through 180°.

2. Hot stamping

For lettering any sizeable quantity we recommend pad printing on the lens holder.

Important!

With pad printing, the position of the lens must agree with the position of the push-button or indicator.
However, the lens can be mounted turned through 180°.

3. Film insert

Instead of engraving, a transparent foil can be laid in the lens tops, except with the colours grey and black.

Foil thickness

0.1 mm max

Ø 18 mm
18 x 18 mm
18 x 24 mm
Ø 24 mm
24 x 24 mm

Ø 12,7 mm
12,7 x 12,7 mm
12,7 x 18,9 mm
Ø 18,3 mm
18,3 x 18,3 mm

Filmdickemax. 0,1mm



Important!

When a foil is used, the position of the lens must agree with the position of the push-button or indicator.
However, the lens can be mounted turned through 180°.

Height of letters	'round' 18		18 x 18		18 x 24		24 x 18		'round' 24		24 x 24	
	Number of lines	- Number of letters per line	Number of lines	- Number of letters per line	Number of lines	- Number of letters per line	Number of lines	- Number of letters per line	Number of lines	- Number of letters per line	Number of lines	- Number of letters per line
h												
2,5 mm	2	5	3	5	3	8	5	5	4	7	5	8
3 mm	2	5	3	5	3	8	4	5	3	7	4	8
4 mm	1	3	2	3	2	5	3	3	3	4	3	6
5 mm	1	2	1	3	1	5	2	3	2	3	2	5

