

Operational Amplifier, 36 V, 3 MHz, 0.95 mV Input Offset Voltage, Rail-to-Rail

NCS20231, NCV20231, NCS20232, NCV20232, NCS20234, NCV20234

The NCS2023x series of op amps feature a wide supply range of 2.7 V to 36 V with an input offset voltage as low as ± 0.95 mV max. These op amps are available in single, dual, and quad channel configurations. Automotive qualified options are available under the NCV prefix with an optional extended operating temperature range from -40°C to 150°C . All other versions are specified over the operating temperature range from -40°C to 125°C .

Features

- Supply Voltage Range: 2.7 V to 36 V
- Temperature Range: -40°C to 150°C
- Unity Gain Bandwidth: 3 MHz
- Input Offset Voltage: ± 1.2 mV max, $T_A = -40$ to 150°C
- Input Offset Voltage Drift: ± 2 $\mu\text{V}/^{\circ}\text{C}$ max
- Common-Mode Input Voltage Range
 - ◆ Optimal: $V_{SS} - 0.1$ to $V_{DD} - 2$ V
 - ◆ Functional: $V_{SS} - 0.1$ to $V_{DD} + 0.1$ V
- NCV Prefix for Automotive and Other Applications Requiring Unique Site and Control Change Requirements; AEC-Q100 Qualified and PPAP Capable
- These Devices are Pb-Free, Halogen Free/BFR Free and are RoHS Compliant

Applications

- Telecom Equipment
- Power Supply Designs
- Diesel Injection Control
- Automotive
- Motor Control

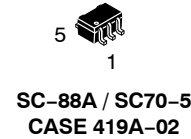

DEVICE MARKING INFORMATION

See general marking information in the device marking section on page 2 of this data sheet.

PIN CONNECTIONS

See pin connections on page 3 of this data sheet.

ORDERING INFORMATION

See detailed ordering and shipping information on page 2 of this data sheet.

DEVICE MARKING INFORMATION

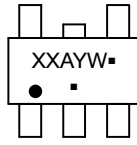

TSOP-5
CASE 483

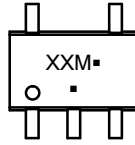

SC-88A / SC70-5
CASE 419A-02



SOT-553, 5 LEAD
CASE 463B

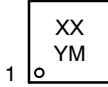

UDFN8, 2x2, 0.5P
CASE 517AW

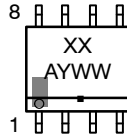

SOIC-8 NB
CASE 751-07

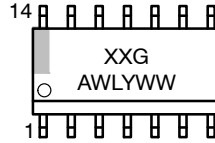

SOIC-14 NB
CASE 751A-03

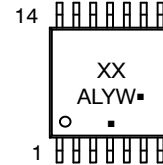

TSSOP-14 WB
CASE 948G

- XX = Specific Device Code
- A = Assembly Location
- Y = Year
- W = Work Week
- M = Date Code
- G or ■ = Pb-Free Package

(Note: Microdot may be in either location)

ORDERING INFORMATION

Temperature	Channels	Package	Device Part Number	Marking	Shipping [†]
Industrial and Commercial					
-40°C to 125°C	Single	TSOP-5	NCS20231SN2T1G	AAC	3000 / Tape & Reel
		SC-88	NCS20231SQ3T2G	AAG	3000 / Tape & Reel
		SOT-553	NCS20231XV53T2G	AC	4000 / Tape & Reel
	Dual	SOIC-8	NCS20232DR2G*	N232	2500 / Tape & Reel
		UDFN-8	NCS20232MUTBG*	DGA	3000 / Tape & Reel
	Quad	SOIC-14	NCS20234DR2G*	234G	2500 / Tape & Reel
		TSSOP-14	NCS20234DTBR2G*	N234	2500 / Tape & Reel
Automotive Qualified, Grade 1					
-40°C to 150°C	Single	TSOP-5	NCV20231SN2T1G	AAC	3000 / Tape & Reel
		SC-88	NCV20231SQ3T2G	AAG	3000 / Tape & Reel
		SOT-553	NCV20231XV53T2G	AC	4000 / Tape & Reel
	Dual	SOIC-8	NCV20232DR2G*	N232	2500 / Tape & Reel
	Quad	SOIC-14	NCV20234DR2G*	234G	2500 / Tape & Reel
		TSSOP-14	NCV20234DTBR2G*	N234	2500 / Tape & Reel

[†]For information on tape and reel specifications, including part orientation and tape sizes, please refer to our Tape and Reel Packaging Specifications Brochure, BRD8011/D.

*In Development. Contact local sales office for more information.

PIN CONNECTIONS

Single Channel

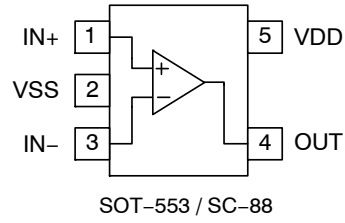
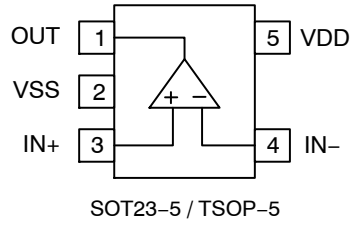

Dual Channel

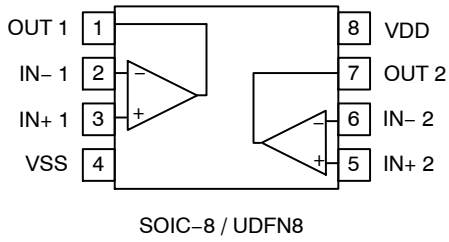

Quad Channel

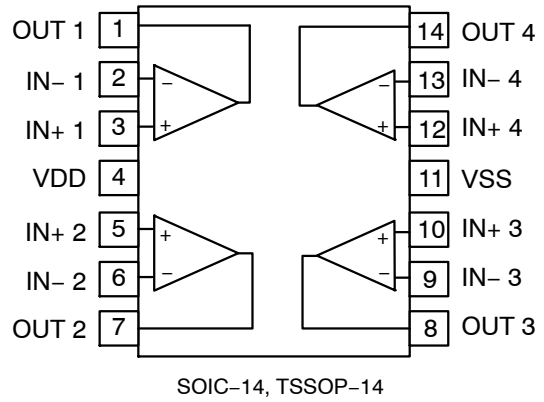

NCS20231, NCV20231, NCS20232, NCV20232, NCS20234, NCV20234

ABSOLUTE MAXIMUM RATINGS (Note 1)

Parameter	Symbol	Value	Unit
Supply Voltage Range ($V_{DD} - V_{SS}$)	V_S	-0.3 to 40	V
Input Common-Mode Voltage	V_{CM}	$V_{SS} - 0.2$ to $V_{DD} + 0.2$	V
Differential Input Voltage	V_{ID}	$\pm V_S$	V
Maximum Input Current	I_I	± 10	mA
Maximum Output Current	I_O	± 100	mA
Continuous Total Power Dissipation	P_D	200	mW
Maximum Junction Temperature	$T_{J(max)}$	150	°C
Storage Temperature Range	T_{STG}	-65 to 150	°C
ESD Capability, Human Body Model (Note 2)	HBM	± 2000	V
ESD Capability, Charge Device Model (Note 2)	CDM	± 1000	V
Moisture Sensitivity Level	MSL	Level 1	
Lead Temperature Soldering Reflow (SMD Styles Only), Pb-Free Versions (Note 3)	T_{SLD}	260	°C

Stresses exceeding those listed in the Maximum Ratings table may damage the device. If any of these limits are exceeded, device functionality should not be assumed, damage may occur and reliability may be affected.

- Refer to ELECTRICAL CHARACTERISTICS and APPLICATION INFORMATION for Safe Operating Area
- This device series incorporates ESD protection and is tested by the following methods:
ESD Human Body Model tested per JEDEC standard JS-001-2017 (AEC-Q100-002)
ESD Charged Device Model tested per JEDEC standard JS-002-2014 (AEC-Q100-011)
- For information, please refer to our Soldering and Mounting Techniques Reference Manual, SOLDERRM/D

THERMAL CHARACTERISTICS (Note 4)

Package	θ_{JA} Junction-to-Ambient Thermal Resistance	Ψ_{JT} Junction-to-Case Top Thermal Characteristic	Ψ_{JB} Junction-to-Board Thermal Characteristic	Unit
TSOP-5 / SOT23-5	254	78	150	°C/W
SC-88A / SC-70-5 / SOT-353	902	70	810	°C/W
SOT-553	238	14	134	°C/W
SOIC-8				°C/W
UDFN-8				°C/W
SOIC-14				°C/W
TSSOP-14				°C/W

- Thermal parameters are based on a 2s2p board following JESD51-7 (JEDEC)

RECOMMENDED OPERATING RANGES (Note 5)

Parameter	Symbol	Min	Max	Unit
Supply Voltage ($V_{DD} - V_{SS}$)	V_S	2.7	36	V
Differential Input Voltage ($V_{IN+} - V_{IN-}$)	V_{ID}		± 5 (Note 6)	V
Input Common-Mode Range (Note 7)	V_{CM}	$V_{SS} - 0.1$	$V_{DD} - 2 V$	V

Functional operation above the stresses listed in the Recommended Operating Ranges is not implied. Extended exposure to stresses beyond the Recommended Operating Ranges limits may affect device reliability.

- Refer to ELECTRICAL CHARACTERISTICS and APPLICATION INFORMATION for Safe Operating Area
- The differential voltage may not exceed the supply voltage, $\pm V_S$. For supplies greater than $V_S = 5 V$, differential voltages up to $\pm V_S$ will consume more input current. See APPLICATION INFORMATION.
- The specified input common mode range yields the best performance. However, the input common mode range is functional up to $V_{DD} + 0.1 V$. See APPLICATION INFORMATION.

NCS20231, NCV20231, NCS20232, NCV20232, NCS20234, NCV20234

ELECTRICAL CHARACTERISTICS ($V_S = 2.7\text{ V to }36\text{ V}$)

At $T_A = +25^\circ\text{C}$, $R_L = 10\text{ k}\Omega$ connected to midsupply, $V_{CM} = V_{OUT} = \text{midsupply}$, unless otherwise noted.

Boldface limits apply over the specified temperature range, guaranteed by characterization and/or design.

Parameter	Symbol	Conditions	Supply Voltage (V)	Temp ($^\circ\text{C}$)	Min	Typ	Max	Unit
INPUT CHARACTERISTICS								
Offset Voltage	V_{OS}	$V_{CM} = \text{mid-supply}$	2.7, 5, 10, 36	25		± 0.3	± 0.95	mV
				-40 to 125			± 1.2	
				-40 to 150			± 1.2	
Offset Voltage Drift over Temperature	dV_{OS}/dT	$V_{CM} = \text{mid-supply}$	2.7, 5, 10, 36	-40 to 125		± 0.5	± 2	$\mu\text{V}/^\circ\text{C}$
				-40 to 150		± 0.5	± 5	
Input Bias Current (Note 8)	I_{IB}		2.7, 5, 10, 36	25		± 5	± 60	pA
				-40 to 125			± 3000	
				150		± 10000		
Input Offset Current (Note 8)	I_{OS}		2.7	25		± 0.5	± 60	pA
				-40 to 125			± 500	
				-40 to 150			± 2000	
			5, 10	25		± 0.5	± 60	pA
				-40 to 125			± 800	
				-40 to 150			± 2500	
			36	25		± 0.5	± 60	pA
				-40 to 125			± 2000	
				-40 to 150			± 2500	
Channel Separation		NCS20232, NCS20234	2.7, 5, 10, 36	25		130		dB
Input Capacitance	C_{IN}	IN+	2.7, 36	25		1		pF
		IN-	2.7, 36	25		6		
Common Mode Rejection Ratio	CMRR	$V_{CM} = V_{SS} - 0.1\text{ V to }V_{DD} - 2\text{ V}$	2.7	25	80	98		dB
				-40 to 125	75			
				-40 to 150	69			
			5 (Note 8)	25	90	105		dB
				-40 to 125	85			
				-40 to 150	80			
			10 (Note 8)	25	100	117		dB
				-40 to 125	100			
				-40 to 150	94			
			36	25	110	122		dB
-40 to 125	110							
-40 to 150	107							
		$V_{CM} = V_{SS} + 1.8\text{ V to }V_{DD} - 2.4\text{ V}$	36	25	117 (Note 8)	125		dB
EMI Rejection Ratio	EMIRR		2.7, 36	25		See Figure 29		dB

8. Guaranteed by design and/or characterization.

NCS20231, NCV20231, NCS20232, NCV20232, NCS20234, NCV20234

ELECTRICAL CHARACTERISTICS ($V_S = 2.7\text{ V to }36\text{ V}$) (continued)

At $T_A = +25^\circ\text{C}$, $R_L = 10\text{ k}\Omega$ connected to midsupply, $V_{CM} = V_{OUT} = \text{midsupply}$, unless otherwise noted.

Boldface limits apply over the specified temperature range, guaranteed by characterization and/or design.

Parameter	Symbol	Conditions	Supply Voltage (V)	Temp ($^\circ\text{C}$)	Min	Typ	Max	Unit			
OUTPUT CHARACTERISTICS											
Open Loop Voltage Gain	A_{VOL}	$V_{CM} = \text{mid-supply}$	2.7	25	100	115		dB			
				-40 to 125	90						
				-40 to 150	90						
			5 (Note 9)	25	120	135					
				-40 to 125	115						
				-40 to 150	115						
			10 (Note 9)	25	130	145					
				-40 to 125	120						
				-40 to 150	120						
			36	25	135	154					
				-40 to 125	130						
				-40 to 150	130						
Open Loop Output Impedance	Z_{OUT}				See Figure 28		Ω				
High Level Output Voltage Swing from V_{DD}	$V_{DD}-V_{OH}$	$R_L = 10\text{ k}\Omega$	2.7, 5, 10, 36	25		60	80	mV			
				-40 to 125			120				
				-40 to 150			150				
			$R_L = 1\text{ mA}$	2.7, 5, 10, 36	25		40		60		
				-40 to 125			80				
				-40 to 150			100				
		$R_L = 5\text{ mA}$	10	25		165	200				
				-40 to 125			350				
				-40 to 150			400				
		Low Level Output Voltage Swing from V_{SS}	$V_{OL}-V_{SS}$	$R_L = 10\text{ k}\Omega$	2.7, 5, 10	25			16	30	mV
						-40 to 125				50	
						-40 to 150				50	
36	25					55	80				
	-40 to 125						250				
	-40 to 150						120				
$R_L = 1\text{ mA}$	2.7, 5, 10, 36				25		35	50			
					-40 to 125			80			
					-40 to 150			80			
$R_L = 5\text{ mA}$	10			25		150	170				
				-40 to 125			300				
				-40 to 150			300				
Output Current Capability	I_{OUT}			Output to V_{DD} rail, sinking current	2.7, 5, 10, 36	25		28		mA	
				Output to V_{SS} rail, sourcing current	2.7, 5, 10, 36	25		28			
Capacitive Load Drive	C_L			Phase margin = 35°	2.7 to 36	25		140		pF	

9. Guaranteed by design and/or characterization.

NCS20231, NCV20231, NCS20232, NCV20232, NCS20234, NCV20234

ELECTRICAL CHARACTERISTICS ($V_S = 2.7\text{ V to }36\text{ V}$) (continued)

At $T_A = +25^\circ\text{C}$, $R_L = 10\text{ k}\Omega$ connected to midsupply, $V_{CM} = V_{OUT} = \text{midsupply}$, unless otherwise noted.

Boldface limits apply over the specified temperature range, guaranteed by characterization and/or design.

Parameter	Symbol	Conditions	Supply Voltage (V)	Temp ($^\circ\text{C}$)	Min	Typ	Max	Unit
DYNAMIC PERFORMANCE								
Gain Bandwidth Product	GWBP	$C_L = 25\text{ pF}$	2.7, 5, 10, 36	25		3		MHz
Gain Margin	A_m	$C_L = 25\text{ pF}$	2.7, 5, 10, 36	25		16		dB
Phase Margin	Φ_m	$C_L = 25\text{ pF}$	2.7, 5, 10, 36	25		60		$^\circ$
Slew Rate	SR	Unity gain, $R_L = 2\text{ k}\Omega$	2.7, 5, 10, 36	25		4		V/ μs
Settling Time to 0.1 %	t_s	$V_{IN} = 1\text{ V step}$	2.7	25		7		μs
		$V_{IN} = 3\text{ V step}$	5	25		7		
		$V_{IN} = 8\text{ V step}$	10	25		7		
		$V_{IN} = 10\text{ V step}$	36	25		6		
Settling Time to 0.01 %	t_s	$V_{IN} = 1\text{ V step}$	2.7	25		20		μs
		$V_{IN} = 3\text{ V step}$	5	25		10		
		$V_{IN} = 8\text{ V step}$	10	25		9		
		$V_{IN} = 10\text{ V step}$	36	25		9		

NOISE PERFORMANCE

Total Harmonic Distortion + Noise	THD+ N	$V_{IN} = 0.5\text{ V}_{pp}$, $f = 1\text{ kHz}$, $A_V = 1$	2.7	25		0.009		%
		$V_{IN} = 2.5\text{ V}_{pp}$, $f = 1\text{ kHz}$, $A_V = 1$	5	25		0.0004		
		$V_{IN} = 7.5\text{ V}_{pp}$, $f = 1\text{ kHz}$, $A_V = 1$	10	25		0.0002		
		$V_{IN} = 28.5\text{ V}_{pp}$, $f = 1\text{ kHz}$, $A_V = 1$	36	25		0.0002		
Voltage Noise Density	e_n	$f = 1\text{ kHz}$	2.7, 5, 10, 36	25		20		nV/ $\sqrt{\text{Hz}}$
		$f = 10\text{ kHz}$				20		
Current Noise Density	i_n	$f = 1\text{ kHz}$	2.7, 5, 10, 36	25		30		fA/ $\sqrt{\text{Hz}}$
Voltage Noise, Peak to Peak	e_{pp}	$f_{IN} = 0.1\text{ Hz to }10\text{ Hz}$	2.7, 5, 10, 36	25		700		nV $_{pp}$

POWER SUPPLY

Power Supply Rejection Ratio	PSRR	$V_S = 2.7\text{ V to }36\text{ V}$	2.7, 36	25	125	138		dB
				-40 to 125	120			
				-40 to 150	120			
Quiescent Current	I_Q	No load, per channel	2.7, 5	25		0.37	0.595	mA
				-40 to 125			0.650	
				-40 to 150			0.7	
			10	25		0.375	0.595	
				-40 to 125			0.650	
				-40 to 150			0.75	
			36	25		0.41	0.595	
				-40 to 125			0.650	
				-40 to 150			0.8	

Product parametric performance is indicated in the Electrical Characteristics for the listed test conditions, unless otherwise noted. Product performance may not be indicated by the Electrical Characteristics if operated under different conditions.

TYPICAL CHARACTERISTICS

Typical Performance at $T_A = 25^\circ\text{C}$, $V_{CM} = \text{mid-supply}$, $C_L = 20 \text{ pF}$, $R_L = 10 \text{ k}\Omega$ to mid-supply, unless otherwise noted

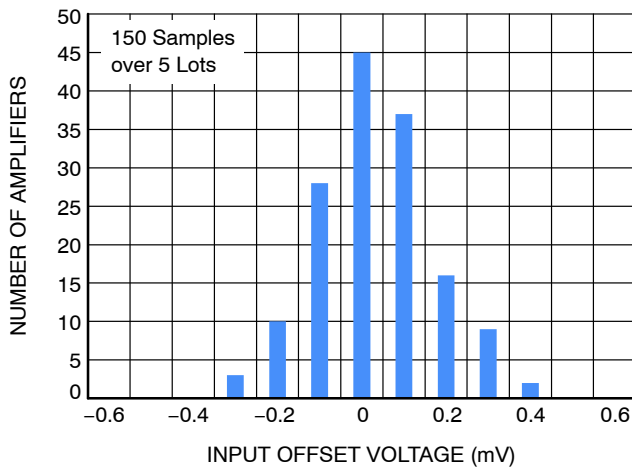

Figure 1. Input Offset Voltage Distribution

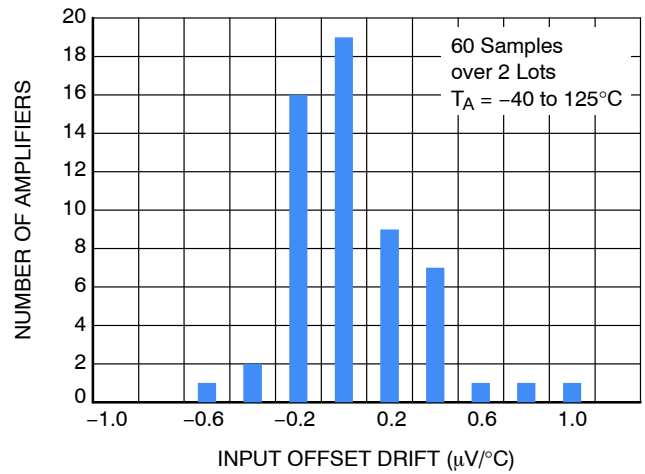

Figure 2. Input Offset Voltage Drift Distribution

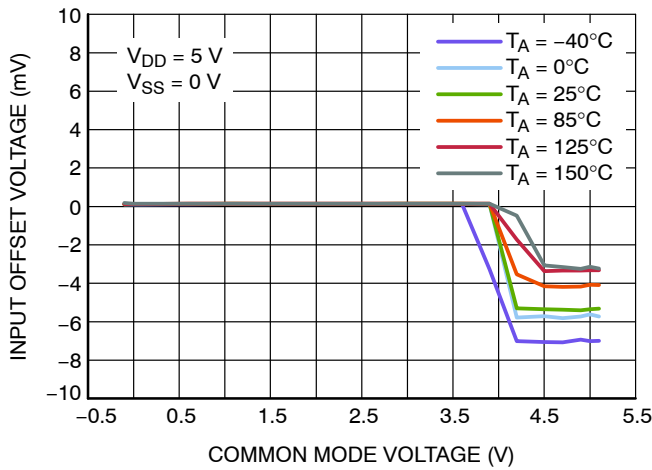

Figure 3. Input Offset Voltage vs. Common Mode Voltage

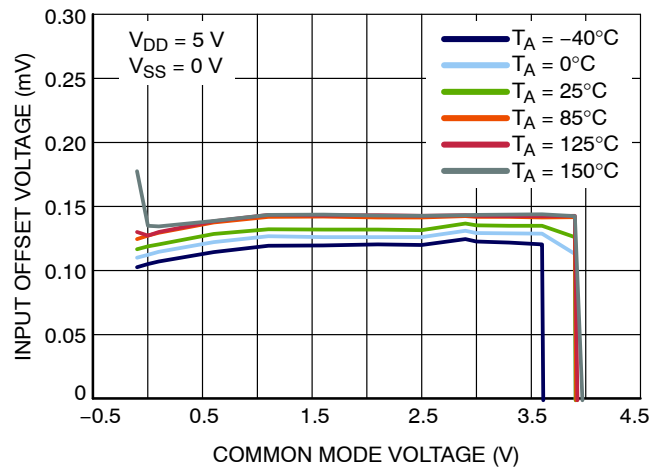

Figure 4. Input Offset Voltage vs. Common Mode Voltage, Performance Region

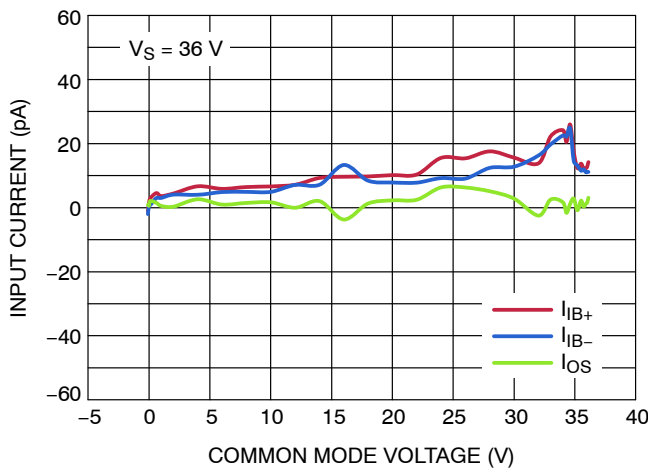

Figure 5. Input Current vs. Common Mode Voltage

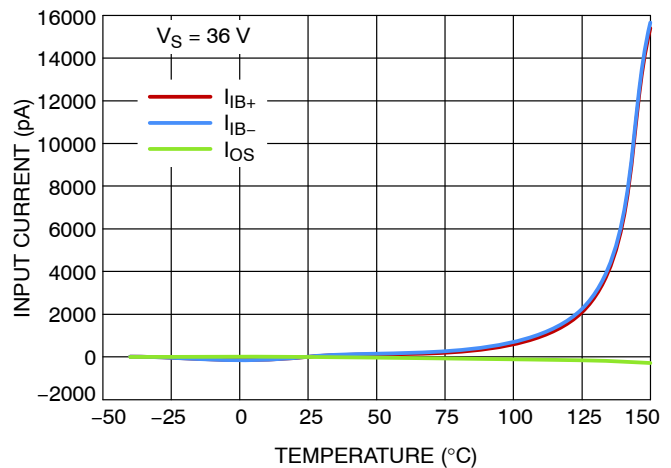

Figure 6. Input Current vs. Temperature

TYPICAL CHARACTERISTICS

Typical Performance at $T_A = 25^\circ\text{C}$, $V_{CM} = \text{mid-supply}$, $C_L = 20\text{ pF}$, $R_L = 10\text{ k}\Omega$ to mid-supply, unless otherwise noted

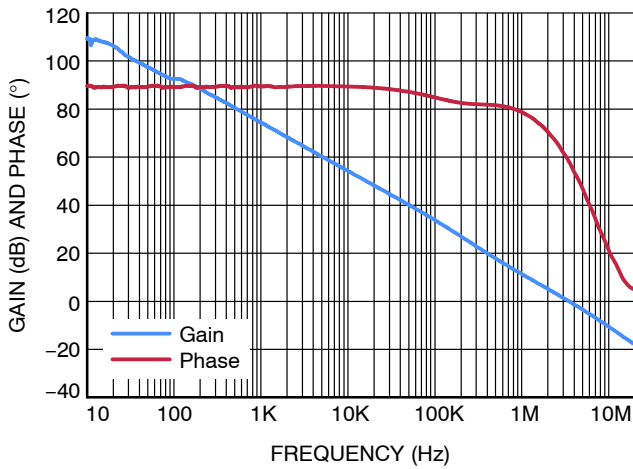

Figure 7. Open Loop Gain and Phase vs. Frequency

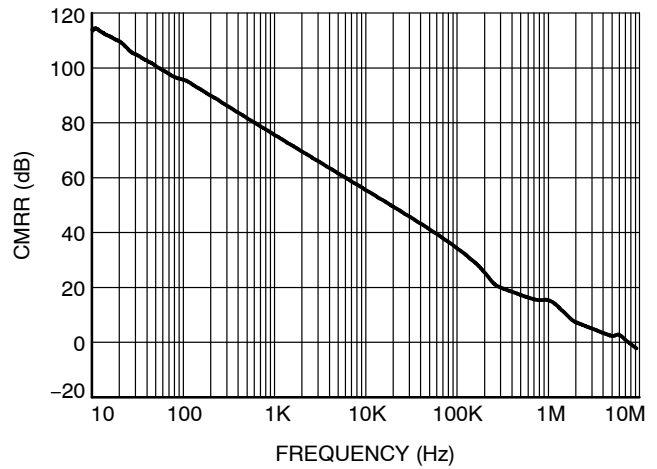

Figure 8. CMRR vs. Frequency

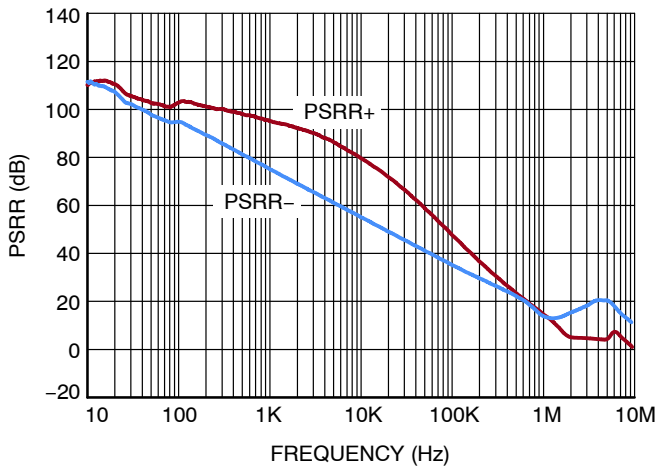

Figure 9. PSRR vs. Frequency

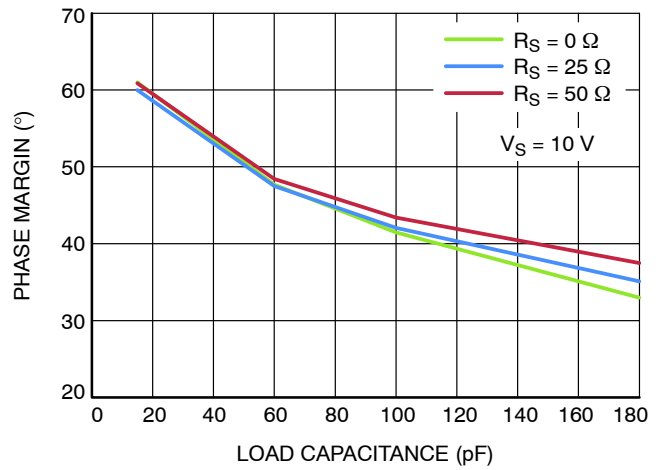

Figure 10. Phase Margin vs. Capacitive Load

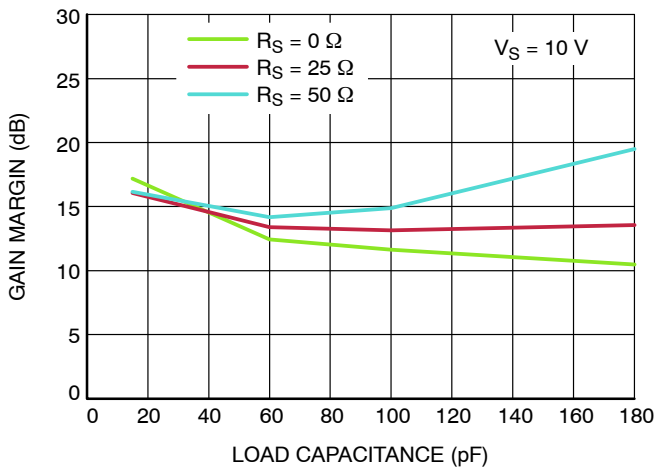

Figure 11. Gain Margin vs. Capacitive Load

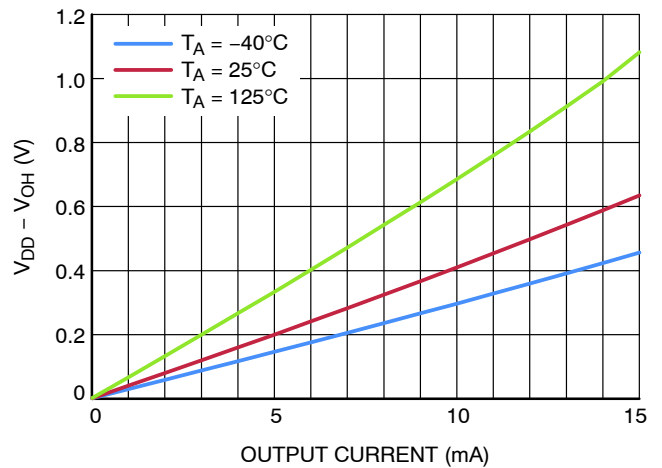

Figure 12. Output Voltage Swing High vs. Output Current at $V_S = 2.7\text{ V}$

TYPICAL CHARACTERISTICS

Typical Performance at $T_A = 25^\circ\text{C}$, $V_{CM} = \text{mid-supply}$, $C_L = 20 \text{ pF}$, $R_L = 10 \text{ k}\Omega$ to mid-supply, unless otherwise noted

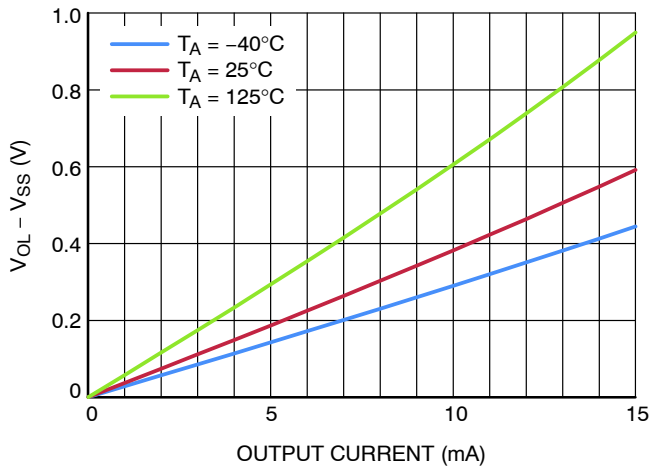

Figure 13. Output Voltage Swing vs. Output Current at $V_S = 2.7 \text{ V}$

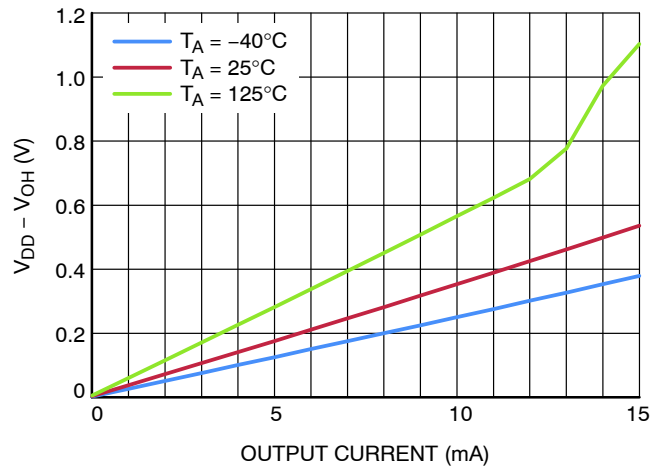

Figure 14. Output Voltage Swing vs. Output Current at $V_S = 36 \text{ V}$

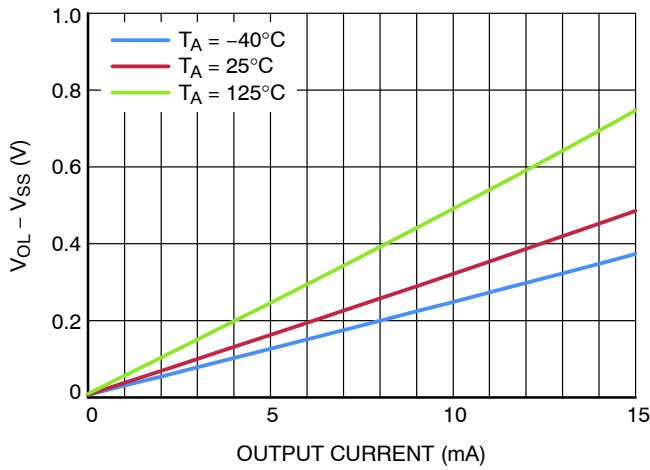

Figure 15. Output Voltage Swing vs. Output Current at $V_S = 36 \text{ V}$

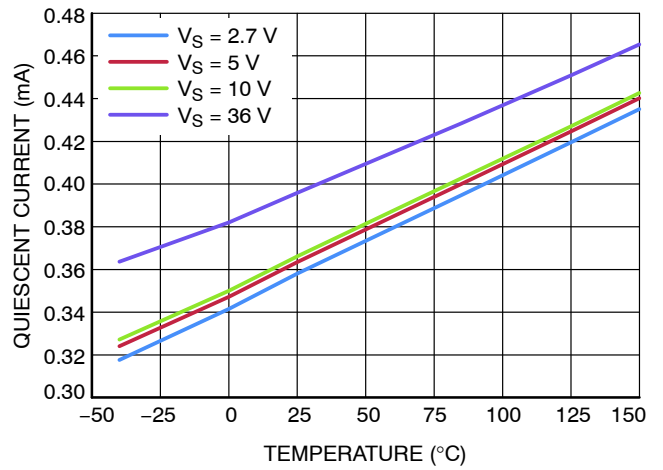

Figure 16. Quiescent Current vs. Temperature

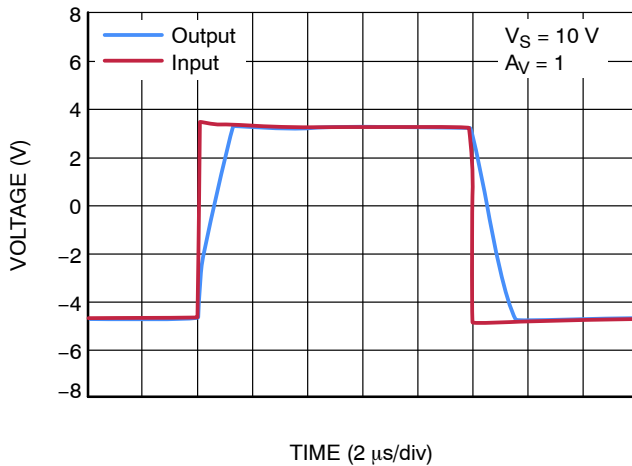

Figure 17. Large Signal Step Response

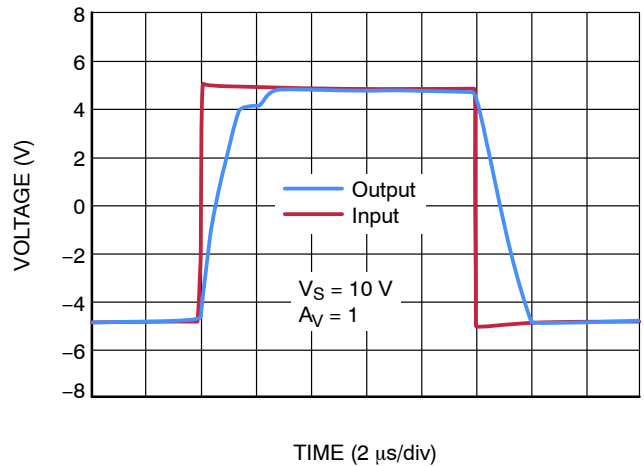
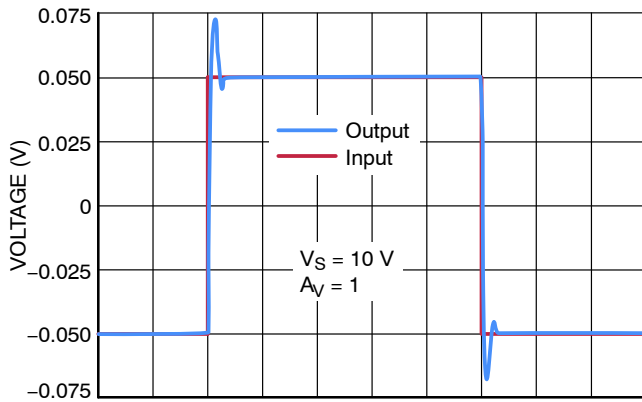

Figure 18. Large Signal Step Response

TYPICAL CHARACTERISTICS

Typical Performance at $T_A = 25^\circ\text{C}$, $V_{CM} = \text{mid-supply}$, $C_L = 20 \text{ pF}$, $R_L = 10 \text{ k}\Omega$ to mid-supply, unless otherwise noted



TIME (1 $\mu\text{s}/\text{div}$)

Figure 19. Small Signal Step Response

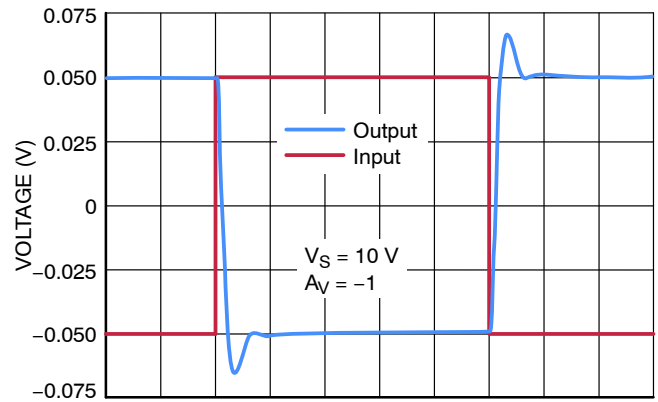

TIME (1 $\mu\text{s}/\text{div}$)

Figure 20. Small Signal Step Response

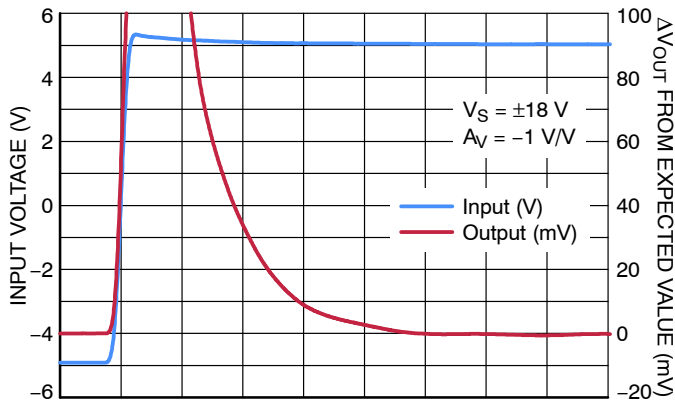

TIME (2 $\mu\text{s}/\text{div}$)

Figure 21. Settling Time

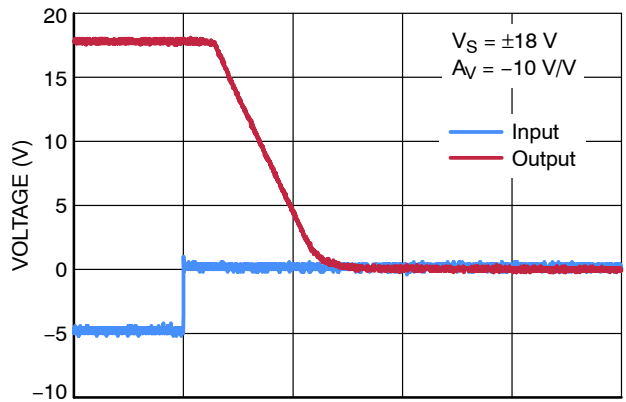

TIME (4 $\mu\text{s}/\text{div}$)

Figure 22. Output Overload Recovery Response

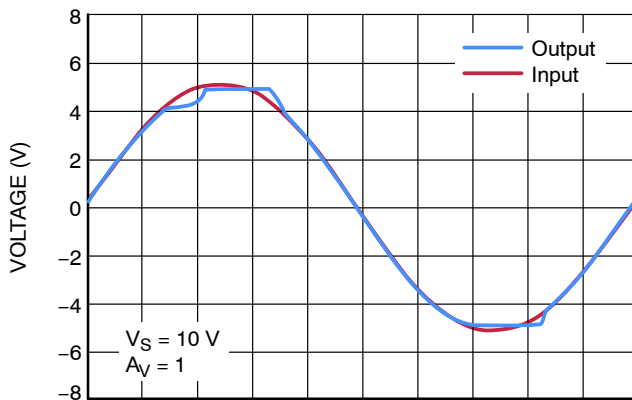

TIME (2 $\mu\text{s}/\text{div}$)

Figure 23. No Phase Reversal

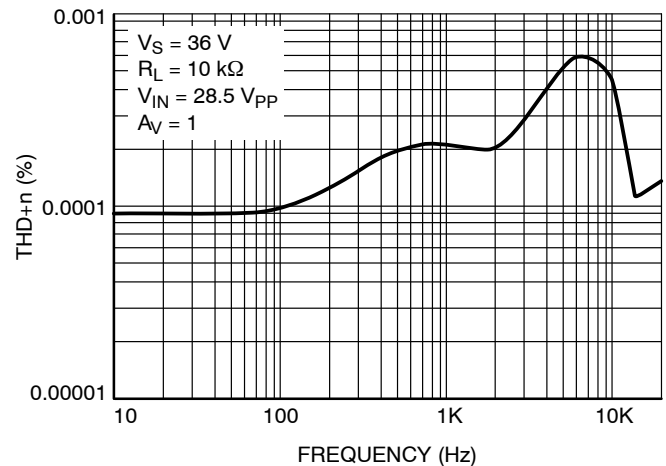

Figure 24. THD+n vs. Frequency

TYPICAL CHARACTERISTICS

Typical Performance at $T_A = 25^\circ\text{C}$, $V_{CM} = \text{mid-supply}$, $C_L = 20 \text{ pF}$, $R_L = 10 \text{ k}\Omega$ to mid-supply, unless otherwise noted

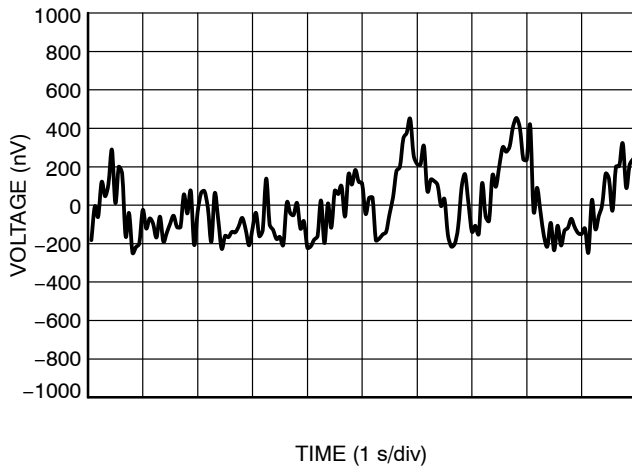

Figure 25. 0.1 Hz to 10 Hz Noise

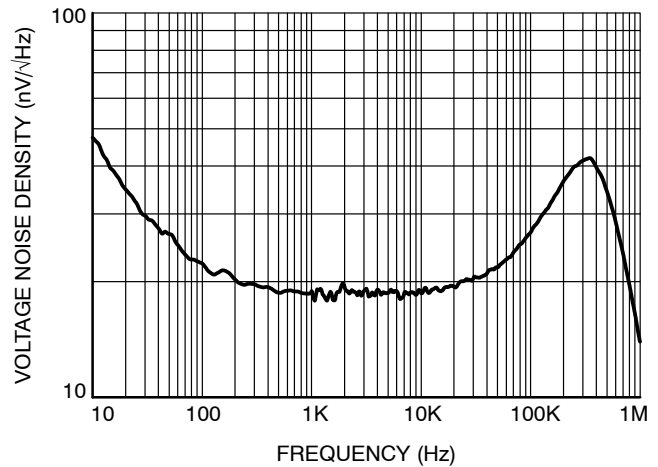

Figure 26. Voltage Noise Density vs. Frequency

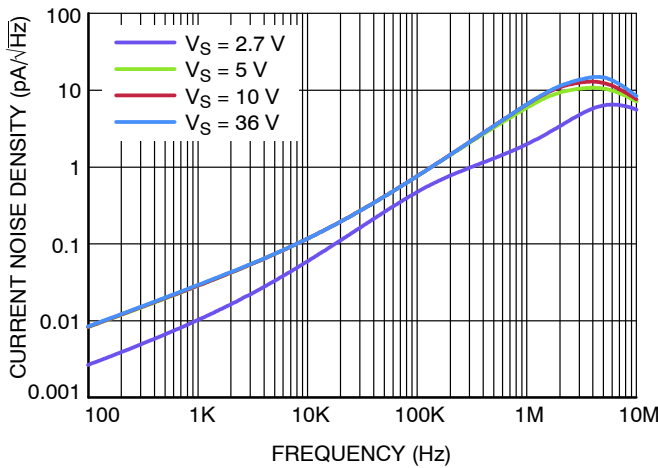

Figure 27. Current Noise Density vs. Frequency

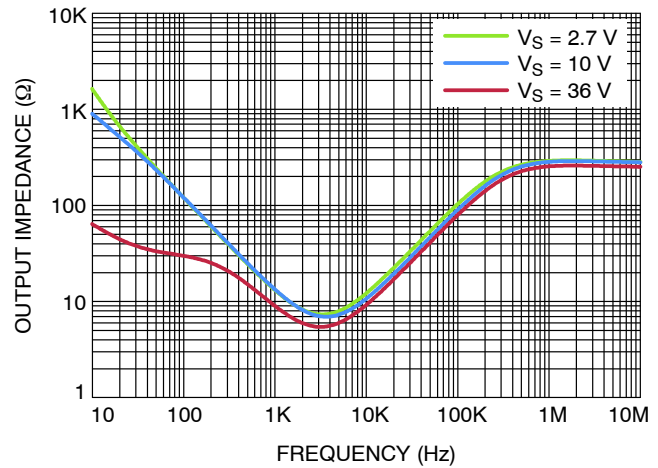

Figure 28. Open Loop Output Impedance vs. Frequency

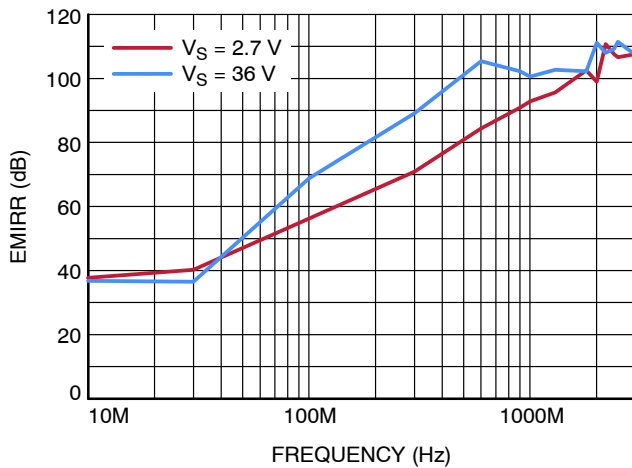

Figure 29. EMIRR vs. Frequency

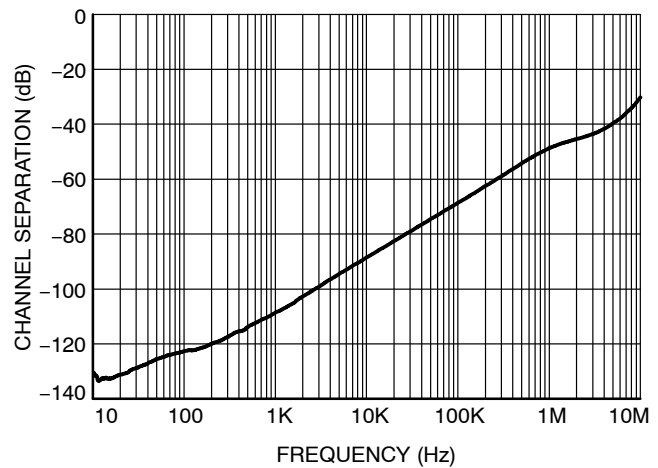

Figure 30. Channel Separation vs. Frequency

APPLICATION INFORMATION

Input and ESD Structure

The NCS20231 series amplifiers have back-to-back Zener diodes, which allow for normal operation with the differential voltage up to ± 5 V. Differential voltages beyond this are permitted, up to $\pm V_S$, but increased input leakage

current should be expected. Internal current limiting resistors in series with the input pins limit the current to ± 10 mA in scenarios where the differential voltage is as high as ± 36 V.

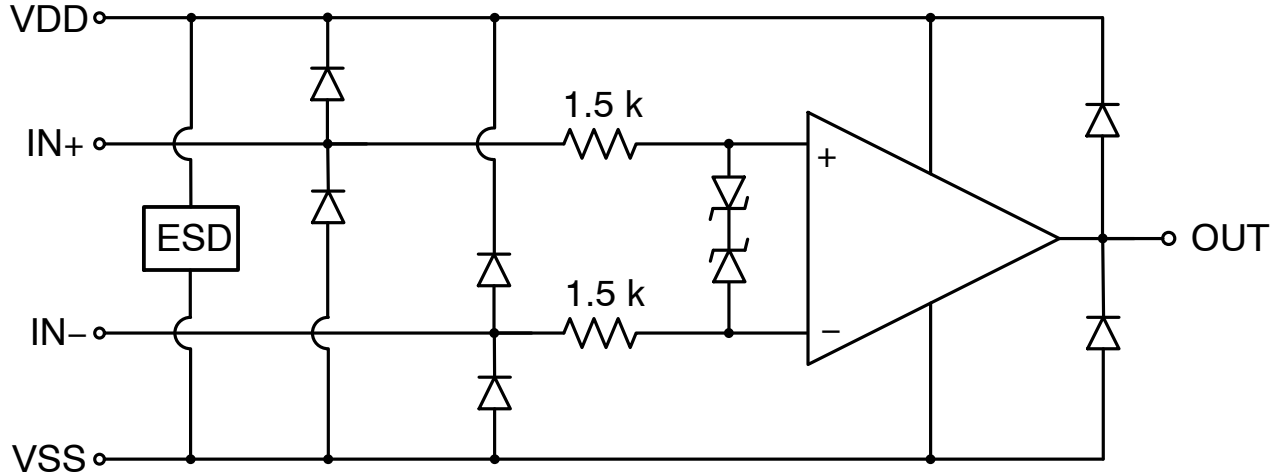

Figure 31. Representative Schematic of the Op Amp

Each input pin is diode clamped to the rails. In case of an input overvoltage, input currents must be limited to within ± 10 mA to prevent excessive current from damaging the part.

Rail-to-Rail Performance

The functional common mode input voltage spans 100 mV beyond the rails. High precision performance, as

shown throughout the ELECTRICAL CHARACTERISTICS table, is achieved in the $V_{SS} - 0.1$ V to $V_{DD} - 2$ V common mode voltage range. The input common mode extends further up to $V_{DD} + 0.1$ V to ensure functionality near the upper rail, though without precision performance in that region. The typical performance within the $V_{DD} - 2$ V to $V_{DD} + 0.1$ V range is shown in the table below.

Parameter	Symbol	Conditions	Typ	Units
Input Offset Voltage	V_{OS}	$V_{CM} = V_{DD} - 0.5$ V	± 9	mV
Input Offset Voltage over Temperature	dV_{OS}/dT		± 24	$\mu V/^\circ C$
Common Mode Rejection Ratio	CMRR	$V_{CM} = V_{DD} - 0.5$ V to $V_{DD} + 0.1$ V	75	dB
Open Loop Voltage Gain	A_{VOL}	$V_{CM} = V_{DD} - 0.5$ V	90	dB
Gain Bandwidth Product	GBWP	$V_{CM} = V_{DD} - 0.5$ V, $C_L = 25$ pF	2.5	MHz
Slew Rate	SR	Unity gain, $V_{CM} = V_{DD} - 1$ V to $V_{DD} - 0.2$ V	1.2	V/ μs
Voltage Noise Density	e_n	$f = 1$ kHz	1000	nV/ \sqrt{Hz}

The NCS2023x does not exhibit output phase reversal. Phase reversal occurs in some amplifiers when the input voltage exceeds the recommended input common mode voltage range, causing the output to flip to the opposite rail.

Instead, when the input common mode voltage range is exceeded on the NCS2023x, the output becomes clipped at the output, limited by the output voltage swing.

MECHANICAL CASE OUTLINE

PACKAGE DIMENSIONS

ON Semiconductor®



SCALE 2:1

SC-88A (SC-70-5/SOT-353)
CASE 419A-02
ISSUE L

DATE 17 JAN 2013



SOLDER FOOTPRINT



NOTES:

1. DIMENSIONING AND TOLERANCING PER ANSI Y14.5M, 1982.
2. CONTROLLING DIMENSION: INCH.
3. 419A-01 OBSOLETE. NEW STANDARD 419A-02.
4. DIMENSIONS A AND B DO NOT INCLUDE MOLD FLASH, PROTRUSIONS, OR GATE BURRS.

DIM	INCHES		MILLIMETERS	
	MIN	MAX	MIN	MAX
A	0.071	0.087	1.80	2.20
B	0.045	0.053	1.15	1.35
C	0.031	0.043	0.80	1.10
D	0.004	0.012	0.10	0.30
G	0.026 BSC		0.65 BSC	
H	---	0.004	---	0.10
J	0.004	0.010	0.10	0.25
K	0.004	0.012	0.10	0.30
N	0.008 REF		0.20 REF	
S	0.079	0.087	2.00	2.20

GENERIC MARKING DIAGRAM*

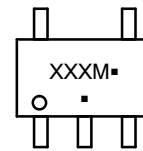

- XXX = Specific Device Code
- M = Date Code
- = Pb-Free Package

(Note: Microdot may be in either location)

*This information is generic. Please refer to device data sheet for actual part marking. Pb-Free indicator, "G" or microdot "▪", may or may not be present. Some products may not follow the Generic Marking.

- | | | | | |
|--|--|--|--|--|
| <p>STYLE 1:
PIN 1. BASE
2. EMITTER
3. BASE
4. COLLECTOR
5. COLLECTOR</p> | <p>STYLE 2:
PIN 1. ANODE
2. EMITTER
3. BASE
4. COLLECTOR
5. CATHODE</p> | <p>STYLE 3:
PIN 1. ANODE 1
2. N/C
3. ANODE 2
4. CATHODE 2
5. CATHODE 1</p> | <p>STYLE 4:
PIN 1. SOURCE 1
2. DRAIN 1/2
3. SOURCE 1
4. GATE 1
5. GATE 2</p> | <p>STYLE 5:
PIN 1. CATHODE
2. COMMON ANODE
3. CATHODE 2
4. CATHODE 3
5. CATHODE 4</p> |
| <p>STYLE 6:
PIN 1. EMITTER 2
2. BASE 2
3. EMITTER 1
4. COLLECTOR
5. COLLECTOR 2/BASE 1</p> | <p>STYLE 7:
PIN 1. BASE
2. EMITTER
3. BASE
4. COLLECTOR
5. COLLECTOR</p> | <p>STYLE 8:
PIN 1. CATHODE
2. COLLECTOR
3. N/C
4. BASE
5. EMITTER</p> | <p>STYLE 9:
PIN 1. ANODE
2. CATHODE
3. ANODE
4. ANODE
5. ANODE</p> | <p>Note: Please refer to datasheet for style callout. If style type is not called out in the datasheet refer to the device datasheet pinout or pin assignment.</p> |

DOCUMENT NUMBER:	98ASB42984B	Electronic versions are uncontrolled except when accessed directly from the Document Repository. Printed versions are uncontrolled except when stamped "CONTROLLED COPY" in red.
DESCRIPTION:	SC-88A (SC-70-5/SOT-353)	PAGE 1 OF 1

ON Semiconductor and ON are trademarks of Semiconductor Components Industries, LLC dba ON Semiconductor or its subsidiaries in the United States and/or other countries. ON Semiconductor reserves the right to make changes without further notice to any products herein. ON Semiconductor makes no warranty, representation or guarantee regarding the suitability of its products for any particular purpose, nor does ON Semiconductor assume any liability arising out of the application or use of any product or circuit, and specifically disclaims any and all liability, including without limitation special, consequential or incidental damages. ON Semiconductor does not convey any license under its patent rights nor the rights of others.

MECHANICAL CASE OUTLINE

PACKAGE DIMENSIONS

ON Semiconductor®



SCALE 4:1

SOT-553, 5 LEAD CASE 463B ISSUE C

DATE 20 MAR 2013

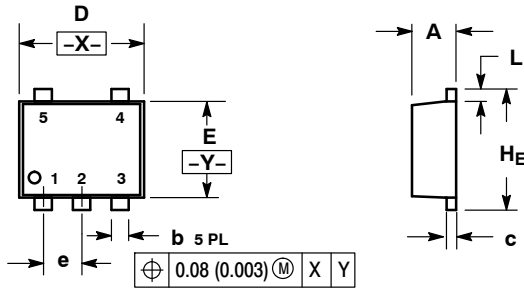

NOTES:

1. DIMENSIONING AND TOLERANCING PER ANSI Y14.5M, 1982.
2. CONTROLLING DIMENSION: MILLIMETERS
3. MAXIMUM LEAD THICKNESS INCLUDES LEAD FINISH THICKNESS. MINIMUM LEAD THICKNESS IS THE MINIMUM THICKNESS OF BASE MATERIAL.

DIM	MILLIMETERS			INCHES		
	MIN	NOM	MAX	MIN	NOM	MAX
A	0.50	0.55	0.60	0.020	0.022	0.024
b	0.17	0.22	0.27	0.007	0.009	0.011
c	0.08	0.13	0.18	0.003	0.005	0.007
D	1.55	1.60	1.65	0.061	0.063	0.065
E	1.15	1.20	1.25	0.045	0.047	0.049
e	0.50 BSC			0.020 BSC		
L	0.10	0.20	0.30	0.004	0.008	0.012
H _E	1.55	1.60	1.65	0.061	0.063	0.065

RECOMMENDED SOLDERING FOOTPRINT*

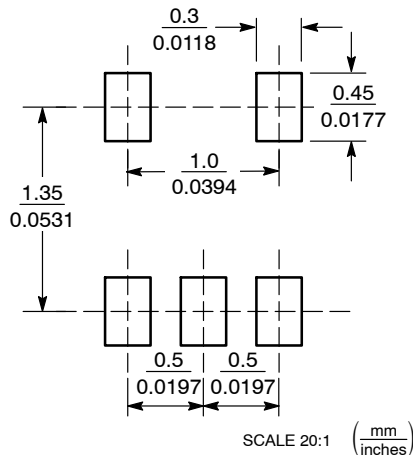

SCALE 20:1 ($\frac{\text{mm}}{\text{inches}}$)

GENERIC MARKING DIAGRAM*



- XX = Specific Device Code
- M = Date Code
- = Pb-Free Package

(Note: Microdot may be in either location)

*This information is generic. Please refer to device data sheet for actual part marking. Pb-Free indicator, "G" or microdot "▪", may or may not be present.

*For additional information on our Pb-Free strategy and soldering details, please download the ON Semiconductor Soldering and Mounting Techniques Reference Manual, SOLDERRM/D.

STYLE 1:

- PIN 1. BASE
- 2. EMITTER
- 3. BASE
- 4. COLLECTOR
- 5. COLLECTOR

STYLE 2:

- PIN 1. CATHODE
- 2. COMMON ANODE
- 3. CATHODE 2
- 4. CATHODE 3
- 5. CATHODE 4

STYLE 3:

- PIN 1. ANODE 1
- 2. N/C
- 3. ANODE 2
- 4. CATHODE 2
- 5. CATHODE 1

STYLE 4:

- PIN 1. SOURCE 1
- 2. DRAIN 1/2
- 3. SOURCE 1
- 4. GATE 1
- 5. GATE 2

STYLE 5:

- PIN 1. ANODE
- 2. EMITTER
- 3. BASE
- 4. COLLECTOR
- 5. CATHODE

STYLE 6:

- PIN 1. EMITTER 2
- 2. BASE 2
- 3. EMITTER 1
- 4. COLLECTOR 1
- 5. COLLECTOR 2/BASE 1

STYLE 7:

- PIN 1. BASE
- 2. EMITTER
- 3. BASE
- 4. COLLECTOR
- 5. COLLECTOR

STYLE 8:

- PIN 1. CATHODE
- 2. COLLECTOR
- 3. N/C
- 4. BASE
- 5. EMITTER

STYLE 9:

- PIN 1. ANODE
- 2. CATHODE
- 3. ANODE
- 4. ANODE
- 5. ANODE

DOCUMENT NUMBER:	98AON11127D	Electronic versions are uncontrolled except when accessed directly from the Document Repository. Printed versions are uncontrolled except when stamped "CONTROLLED COPY" in red.
STATUS:	ON SEMICONDUCTOR STANDARD	
NEW STANDARD:		
DESCRIPTION:	SOT-553, 5 LEAD	PAGE 1 OF 2

MECHANICAL CASE OUTLINE PACKAGE DIMENSIONS

ON Semiconductor®



SCALE 2:1

TSOP-5 CASE 483 ISSUE N

DATE 12 AUG 2020

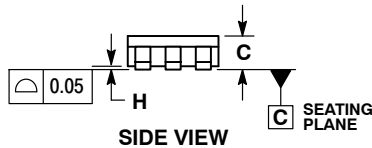

NOTES:

1. DIMENSIONING AND TOLERANCING PER ASME Y14.5M, 1994.
2. CONTROLLING DIMENSION: MILLIMETERS.
3. MAXIMUM LEAD THICKNESS INCLUDES LEAD FINISH THICKNESS. MINIMUM LEAD THICKNESS IS THE MINIMUM THICKNESS OF BASE MATERIAL.
4. DIMENSIONS A AND B DO NOT INCLUDE MOLD FLASH, PROTRUSIONS, OR GATE BURRS. MOLD FLASH, PROTRUSIONS, OR GATE BURRS SHALL NOT EXCEED 0.15 PER SIDE. DIMENSION A.
5. OPTIONAL CONSTRUCTION: AN ADDITIONAL TRIMMED LEAD IS ALLOWED IN THIS LOCATION. TRIMMED LEAD NOT TO EXTEND MORE THAN 0.2 FROM BODY.

DIM	MILLIMETERS	
	MIN	MAX
A	2.85	3.15
B	1.35	1.65
C	0.90	1.10
D	0.25	0.50
G	0.95 BSC	
H	0.01	0.10
J	0.10	0.26
K	0.20	0.60
M	0°	10°
S	2.50	3.00

SOLDERING FOOTPRINT*



*For additional information on our Pb-Free strategy and soldering details, please download the ON Semiconductor Soldering and Mounting Techniques Reference Manual, SOLDERRM/D.

GENERIC MARKING DIAGRAM*



- XXX = Specific Device Code XXX = Specific Device Code
 A = Assembly Location M = Date Code
 Y = Year ▪ = Pb-Free Package
 W = Work Week
 ▪ = Pb-Free Package

(Note: Microdot may be in either location)

*This information is generic. Please refer to device data sheet for actual part marking. Pb-Free indicator, "G" or microdot "▪", may or may not be present.

DOCUMENT NUMBER:	98ARB18753C	Electronic versions are uncontrolled except when accessed directly from the Document Repository. Printed versions are uncontrolled except when stamped "CONTROLLED COPY" in red.
DESCRIPTION:	TSOP-5	PAGE 1 OF 1

ON Semiconductor and ON are trademarks of Semiconductor Components Industries, LLC dba ON Semiconductor or its subsidiaries in the United States and/or other countries. ON Semiconductor reserves the right to make changes without further notice to any products herein. ON Semiconductor makes no warranty, representation or guarantee regarding the suitability of its products for any particular purpose, nor does ON Semiconductor assume any liability arising out of the application or use of any product or circuit, and specifically disclaims any and all liability, including without limitation special, consequential or incidental damages. ON Semiconductor does not convey any license under its patent rights nor the rights of others.

MECHANICAL CASE OUTLINE

PACKAGE DIMENSIONS

ON Semiconductor®



SCALE 2:1

UDFN8, 2x2
CASE 517AW
ISSUE A

DATE 13 NOV 2015

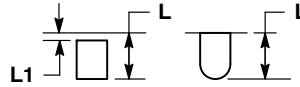
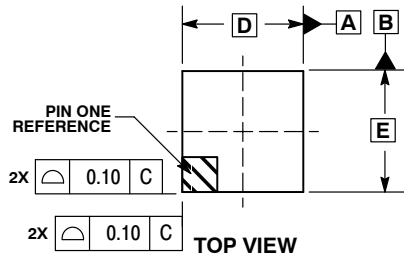

DETAIL A
ALTERNATE
CONSTRUCTIONS

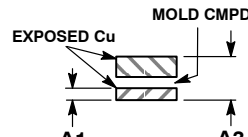
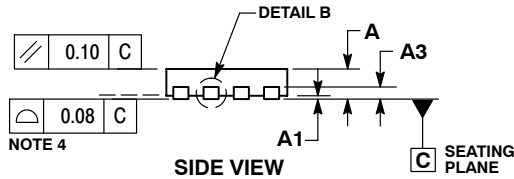

DETAIL B
ALTERNATE
CONSTRUCTION

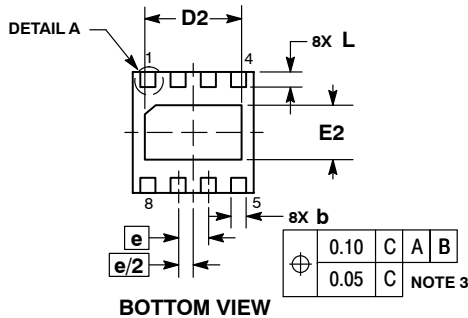

RECOMMENDED SOLDERING FOOTPRINT*

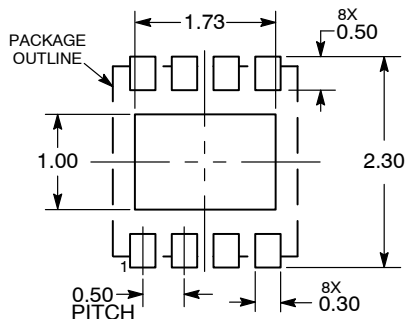

DIMENSIONS: MILLIMETERS

NOTES:

- DIMENSIONING AND TOLERANCING PER ASME Y14.5M, 1994.
- CONTROLLING DIMENSION: MILLIMETERS.
- DIMENSION b APPLIES TO PLATED TERMINALS AND IS MEASURED BETWEEN 0.15 AND 0.30 MM FROM THE TERMINAL TIP.
- COPLANARITY APPLIES TO THE EXPOSED PAD AS WELL AS THE TERMINALS.
- FOR DEVICE OPN CONTAINING W OPTION, DETAIL B ALTERNATE CONSTRUCTION IS NOT APPLICABLE.

DIM	MILLIMETERS	
	MIN	MAX
A	0.45	0.55
A1	0.00	0.05
A3	0.13 REF	
b	0.18	0.30
D	2.00 BSC	
D2	1.50	1.70
E	2.00 BSC	
E2	0.80	1.00
e	0.50 BSC	
L	0.20	0.45
L1	---	0.15

GENERIC MARKING DIAGRAM*

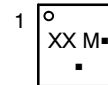

- XX = Specific Device Code
- M = Date Code
- = Pb-Free Package

(Note: Microdot may be in either location)
*This information is generic. Please refer to device data sheet for actual part marking. Pb-Free indicator, "G" or microdot "▪", may or may not be present.

*For additional information on our Pb-Free strategy and soldering details, please download the ON Semiconductor Soldering and Mounting Techniques Reference Manual, SOLDERRM/D.

DOCUMENT NUMBER:	98AON34462E	Electronic versions are uncontrolled except when accessed directly from the Document Repository. Printed versions are uncontrolled except when stamped "CONTROLLED COPY" in red.
DESCRIPTION:	UDFN8, 2X2	PAGE 1 OF 1

ON Semiconductor and ON are trademarks of Semiconductor Components Industries, LLC dba ON Semiconductor or its subsidiaries in the United States and/or other countries. ON Semiconductor reserves the right to make changes without further notice to any products herein. ON Semiconductor makes no warranty, representation or guarantee regarding the suitability of its products for any particular purpose, nor does ON Semiconductor assume any liability arising out of the application or use of any product or circuit, and specifically disclaims any and all liability, including without limitation special, consequential or incidental damages. ON Semiconductor does not convey any license under its patent rights nor the rights of others.

MECHANICAL CASE OUTLINE PACKAGE DIMENSIONS



SCALE 1:1

SOIC-8 NB
CASE 751-07
ISSUE AK

DATE 16 FEB 2011



- NOTES:
1. DIMENSIONING AND TOLERANCING PER ANSI Y14.5M, 1982.
 2. CONTROLLING DIMENSION: MILLIMETER.
 3. DIMENSION A AND B DO NOT INCLUDE MOLD PROTRUSION.
 4. MAXIMUM MOLD PROTRUSION 0.15 (0.006) PER SIDE.
 5. DIMENSION D DOES NOT INCLUDE DAMBAR PROTRUSION. ALLOWABLE DAMBAR PROTRUSION SHALL BE 0.127 (0.005) TOTAL IN EXCESS OF THE D DIMENSION AT MAXIMUM MATERIAL CONDITION.
 6. 751-01 THRU 751-06 ARE OBSOLETE. NEW STANDARD IS 751-07.

DIM	MILLIMETERS		INCHES	
	MIN	MAX	MIN	MAX
A	4.80	5.00	0.189	0.197
B	3.80	4.00	0.150	0.157
C	1.35	1.75	0.053	0.069
D	0.33	0.51	0.013	0.020
G	1.27 BSC		0.050 BSC	
H	0.10	0.25	0.004	0.010
J	0.19	0.25	0.007	0.010
K	0.40	1.27	0.016	0.050
M	0°	8°	0°	8°
N	0.25	0.50	0.010	0.020
S	5.80	6.20	0.228	0.244

SOLDERING FOOTPRINT*



*For additional information on our Pb-Free strategy and soldering details, please download the ON Semiconductor Soldering and Mounting Techniques Reference Manual, SOLDERRM/D.

GENERIC MARKING DIAGRAM*



- XXXXXX = Specific Device Code
- A = Assembly Location
- L = Wafer Lot
- Y = Year
- W = Work Week
- = Pb-Free Package

- XXXXXX = Specific Device Code
- A = Assembly Location
- Y = Year
- WW = Work Week
- = Pb-Free Package

*This information is generic. Please refer to device data sheet for actual part marking. Pb-Free indicator, "G" or microdot "▪", may or may not be present. Some products may not follow the Generic Marking.

STYLES ON PAGE 2

DOCUMENT NUMBER:	98ASB42564B	Electronic versions are uncontrolled except when accessed directly from the Document Repository. Printed versions are uncontrolled except when stamped "CONTROLLED COPY" in red.
DESCRIPTION:	SOIC-8 NB	PAGE 1 OF 2

onsemi and ONsemi are trademarks of Semiconductor Components Industries, LLC dba onsemi or its subsidiaries in the United States and/or other countries. onsemi reserves the right to make changes without further notice to any products herein. onsemi makes no warranty, representation or guarantee regarding the suitability of its products for any particular purpose, nor does onsemi assume any liability arising out of the application or use of any product or circuit, and specifically disclaims any and all liability, including without limitation special, consequential or incidental damages. onsemi does not convey any license under its patent rights nor the rights of others.

SOIC-8 NB
CASE 751-07
ISSUE AK

DATE 16 FEB 2011

- | | | | |
|---|--|--|--|
| <p>STYLE 1:
 PIN 1. EMITTER
 2. COLLECTOR
 3. COLLECTOR
 4. EMITTER
 5. EMITTER
 6. BASE
 7. BASE
 8. EMITTER</p> | <p>STYLE 2:
 PIN 1. COLLECTOR, DIE, #1
 2. COLLECTOR, #1
 3. COLLECTOR, #2
 4. COLLECTOR, #2
 5. BASE, #2
 6. EMITTER, #2
 7. BASE, #1
 8. EMITTER, #1</p> | <p>STYLE 3:
 PIN 1. DRAIN, DIE #1
 2. DRAIN, #1
 3. DRAIN, #2
 4. DRAIN, #2
 5. GATE, #2
 6. SOURCE, #2
 7. GATE, #1
 8. SOURCE, #1</p> | <p>STYLE 4:
 PIN 1. ANODE
 2. ANODE
 3. ANODE
 4. ANODE
 5. ANODE
 6. ANODE
 7. ANODE
 8. COMMON CATHODE</p> |
| <p>STYLE 5:
 PIN 1. DRAIN
 2. DRAIN
 3. DRAIN
 4. DRAIN
 5. GATE
 6. GATE
 7. SOURCE
 8. SOURCE</p> | <p>STYLE 6:
 PIN 1. SOURCE
 2. DRAIN
 3. DRAIN
 4. SOURCE
 5. SOURCE
 6. GATE
 7. GATE
 8. SOURCE</p> | <p>STYLE 7:
 PIN 1. INPUT
 2. EXTERNAL BYPASS
 3. THIRD STAGE SOURCE
 4. GROUND
 5. DRAIN
 6. GATE 3
 7. SECOND STAGE Vd
 8. FIRST STAGE Vd</p> | <p>STYLE 8:
 PIN 1. COLLECTOR, DIE #1
 2. BASE, #1
 3. BASE, #2
 4. COLLECTOR, #2
 5. COLLECTOR, #2
 6. EMITTER, #2
 7. EMITTER, #1
 8. COLLECTOR, #1</p> |
| <p>STYLE 9:
 PIN 1. EMITTER, COMMON
 2. COLLECTOR, DIE #1
 3. COLLECTOR, DIE #2
 4. EMITTER, COMMON
 5. EMITTER, COMMON
 6. BASE, DIE #2
 7. BASE, DIE #1
 8. EMITTER, COMMON</p> | <p>STYLE 10:
 PIN 1. GROUND
 2. BIAS 1
 3. OUTPUT
 4. GROUND
 5. GROUND
 6. BIAS 2
 7. INPUT
 8. GROUND</p> | <p>STYLE 11:
 PIN 1. SOURCE 1
 2. GATE 1
 3. SOURCE 2
 4. GATE 2
 5. DRAIN 2
 6. DRAIN 2
 7. DRAIN 1
 8. DRAIN 1</p> | <p>STYLE 12:
 PIN 1. SOURCE
 2. SOURCE
 3. SOURCE
 4. GATE
 5. DRAIN
 6. DRAIN
 7. DRAIN
 8. DRAIN</p> |
| <p>STYLE 13:
 PIN 1. N.C.
 2. SOURCE
 3. SOURCE
 4. GATE
 5. DRAIN
 6. DRAIN
 7. DRAIN
 8. DRAIN</p> | <p>STYLE 14:
 PIN 1. N-SOURCE
 2. N-GATE
 3. P-SOURCE
 4. P-GATE
 5. P-DRAIN
 6. P-DRAIN
 7. N-DRAIN
 8. N-DRAIN</p> | <p>STYLE 15:
 PIN 1. ANODE 1
 2. ANODE 1
 3. ANODE 1
 4. ANODE 1
 5. CATHODE, COMMON
 6. CATHODE, COMMON
 7. CATHODE, COMMON
 8. CATHODE, COMMON</p> | <p>STYLE 16:
 PIN 1. EMITTER, DIE #1
 2. BASE, DIE #1
 3. EMITTER, DIE #2
 4. BASE, DIE #2
 5. COLLECTOR, DIE #2
 6. COLLECTOR, DIE #2
 7. COLLECTOR, DIE #1
 8. COLLECTOR, DIE #1</p> |
| <p>STYLE 17:
 PIN 1. VCC
 2. V2OUT
 3. V1OUT
 4. TXE
 5. RXE
 6. VEE
 7. GND
 8. ACC</p> | <p>STYLE 18:
 PIN 1. ANODE
 2. ANODE
 3. SOURCE
 4. GATE
 5. DRAIN
 6. DRAIN
 7. CATHODE
 8. CATHODE</p> | <p>STYLE 19:
 PIN 1. SOURCE 1
 2. GATE 1
 3. SOURCE 2
 4. GATE 2
 5. DRAIN 2
 6. MIRROR 2
 7. DRAIN 1
 8. MIRROR 1</p> | <p>STYLE 20:
 PIN 1. SOURCE (N)
 2. GATE (N)
 3. SOURCE (P)
 4. GATE (P)
 5. DRAIN
 6. DRAIN
 7. DRAIN
 8. DRAIN</p> |
| <p>STYLE 21:
 PIN 1. CATHODE 1
 2. CATHODE 2
 3. CATHODE 3
 4. CATHODE 4
 5. CATHODE 5
 6. COMMON ANODE
 7. COMMON ANODE
 8. CATHODE 6</p> | <p>STYLE 22:
 PIN 1. I/O LINE 1
 2. COMMON CATHODE/VCC
 3. COMMON CATHODE/VCC
 4. I/O LINE 3
 5. COMMON ANODE/GND
 6. I/O LINE 4
 7. I/O LINE 5
 8. COMMON ANODE/GND</p> | <p>STYLE 23:
 PIN 1. LINE 1 IN
 2. COMMON ANODE/GND
 3. COMMON ANODE/GND
 4. LINE 2 IN
 5. LINE 2 OUT
 6. COMMON ANODE/GND
 7. COMMON ANODE/GND
 8. LINE 1 OUT</p> | <p>STYLE 24:
 PIN 1. BASE
 2. EMITTER
 3. COLLECTOR/ANODE
 4. COLLECTOR/ANODE
 5. CATHODE
 6. CATHODE
 7. COLLECTOR/ANODE
 8. COLLECTOR/ANODE</p> |
| <p>STYLE 25:
 PIN 1. VIN
 2. N/C
 3. REXT
 4. GND
 5. IOUT
 6. IOUT
 7. IOUT
 8. IOUT</p> | <p>STYLE 26:
 PIN 1. GND
 2. dv/dt
 3. ENABLE
 4. ILIMIT
 5. SOURCE
 6. SOURCE
 7. SOURCE
 8. VCC</p> | <p>STYLE 27:
 PIN 1. ILIMIT
 2. OVLO
 3. UVLO
 4. INPUT+
 5. SOURCE
 6. SOURCE
 7. SOURCE
 8. DRAIN</p> | <p>STYLE 28:
 PIN 1. SW_TO_GND
 2. DASIC_OFF
 3. DASIC_SW_DET
 4. GND
 5. V_MON
 6. VBULK
 7. VBULK
 8. VIN</p> |
| <p>STYLE 29:
 PIN 1. BASE, DIE #1
 2. EMITTER, #1
 3. BASE, #2
 4. EMITTER, #2
 5. COLLECTOR, #2
 6. COLLECTOR, #2
 7. COLLECTOR, #1
 8. COLLECTOR, #1</p> | <p>STYLE 30:
 PIN 1. DRAIN 1
 2. DRAIN 1
 3. GATE 2
 4. SOURCE 2
 5. SOURCE 1/DRAIN 2
 6. SOURCE 1/DRAIN 2
 7. SOURCE 1/DRAIN 2
 8. GATE 1</p> | | |

DOCUMENT NUMBER:	98ASB42564B	Electronic versions are uncontrolled except when accessed directly from the Document Repository. Printed versions are uncontrolled except when stamped "CONTROLLED COPY" in red.
DESCRIPTION:	SOIC-8 NB	PAGE 2 OF 2

onsemi and **ONSEMI** are trademarks of Semiconductor Components Industries, LLC dba **onsemi** or its subsidiaries in the United States and/or other countries. **onsemi** reserves the right to make changes without further notice to any products herein. **onsemi** makes no warranty, representation or guarantee regarding the suitability of its products for any particular purpose, nor does **onsemi** assume any liability arising out of the application or use of any product or circuit, and specifically disclaims any and all liability, including without limitation special, consequential or incidental damages. **onsemi** does not convey any license under its patent rights nor the rights of others.

MECHANICAL CASE OUTLINE PACKAGE DIMENSIONS



SCALE 1:1

SOIC-14 NB
CASE 751A-03
ISSUE L

DATE 03 FEB 2016



NOTES:

1. DIMENSIONING AND TOLERANCING PER ASME Y14.5M, 1994.
2. CONTROLLING DIMENSION: MILLIMETERS.
3. DIMENSION b DOES NOT INCLUDE DAMBAR PROTRUSION. ALLOWABLE PROTRUSION SHALL BE 0.13 TOTAL IN EXCESS OF AT MAXIMUM MATERIAL CONDITION.
4. DIMENSIONS D AND E DO NOT INCLUDE MOLD PROTRUSIONS.
5. MAXIMUM MOLD PROTRUSION 0.15 PER SIDE.

DIM	MILLIMETERS		INCHES	
	MIN	MAX	MIN	MAX
A	1.35	1.75	0.054	0.068
A1	0.10	0.25	0.004	0.010
A3	0.19	0.25	0.008	0.010
b	0.35	0.49	0.014	0.019
D	8.55	8.75	0.337	0.344
E	3.80	4.00	0.150	0.157
e	1.27 BSC		0.050 BSC	
H	5.80	6.20	0.228	0.244
h	0.25	0.50	0.010	0.019
L	0.40	1.25	0.016	0.049
M	0°	7°	0°	7°

SOLDERING FOOTPRINT*



DIMENSIONS: MILLIMETERS

*For additional information on our Pb-Free strategy and soldering details, please download the ON Semiconductor Soldering and Mounting Techniques Reference Manual, SOLDERRM/D.

GENERIC MARKING DIAGRAM*



- XXXXXX = Specific Device Code
- A = Assembly Location
- WL = Wafer Lot
- Y = Year
- WW = Work Week
- G = Pb-Free Package

*This information is generic. Please refer to device data sheet for actual part marking. Pb-Free indicator, "G" or microdot "▪", may or may not be present. Some products may not follow the Generic Marking.

STYLES ON PAGE 2

DOCUMENT NUMBER:	98ASB42565B	Electronic versions are uncontrolled except when accessed directly from the Document Repository. Printed versions are uncontrolled except when stamped "CONTROLLED COPY" in red.
DESCRIPTION:	SOIC-14 NB	PAGE 1 OF 2

onsemi and ONSEMI are trademarks of Semiconductor Components Industries, LLC dba onsemi or its subsidiaries in the United States and/or other countries. onsemi reserves the right to make changes without further notice to any products herein. onsemi makes no warranty, representation or guarantee regarding the suitability of its products for any particular purpose, nor does onsemi assume any liability arising out of the application or use of any product or circuit, and specifically disclaims any and all liability, including without limitation special, consequential or incidental damages. onsemi does not convey any license under its patent rights nor the rights of others.

SOIC-14
CASE 751A-03
ISSUE L

DATE 03 FEB 2016

STYLE 1:
 PIN 1. COMMON CATHODE
 2. ANODE/CATHODE
 3. ANODE/CATHODE
 4. NO CONNECTION
 5. ANODE/CATHODE
 6. NO CONNECTION
 7. ANODE/CATHODE
 8. ANODE/CATHODE
 9. ANODE/CATHODE
 10. NO CONNECTION
 11. ANODE/CATHODE
 12. ANODE/CATHODE
 13. NO CONNECTION
 14. COMMON ANODE

STYLE 2:
 CANCELLED

STYLE 3:
 PIN 1. NO CONNECTION
 2. ANODE
 3. ANODE
 4. NO CONNECTION
 5. ANODE
 6. NO CONNECTION
 7. ANODE
 8. ANODE
 9. ANODE
 10. NO CONNECTION
 11. ANODE
 12. ANODE
 13. NO CONNECTION
 14. COMMON CATHODE

STYLE 4:
 PIN 1. NO CONNECTION
 2. CATHODE
 3. CATHODE
 4. NO CONNECTION
 5. CATHODE
 6. NO CONNECTION
 7. CATHODE
 8. CATHODE
 9. CATHODE
 10. NO CONNECTION
 11. CATHODE
 12. CATHODE
 13. NO CONNECTION
 14. COMMON ANODE

STYLE 5:
 PIN 1. COMMON CATHODE
 2. ANODE/CATHODE
 3. ANODE/CATHODE
 4. ANODE/CATHODE
 5. ANODE/CATHODE
 6. NO CONNECTION
 7. COMMON ANODE
 8. COMMON CATHODE
 9. ANODE/CATHODE
 10. ANODE/CATHODE
 11. ANODE/CATHODE
 12. ANODE/CATHODE
 13. NO CONNECTION
 14. COMMON ANODE

STYLE 6:
 PIN 1. CATHODE
 2. CATHODE
 3. CATHODE
 4. CATHODE
 5. CATHODE
 6. CATHODE
 7. CATHODE
 8. ANODE
 9. ANODE
 10. ANODE
 11. ANODE
 12. ANODE
 13. ANODE
 14. ANODE

STYLE 7:
 PIN 1. ANODE/CATHODE
 2. COMMON ANODE
 3. COMMON CATHODE
 4. ANODE/CATHODE
 5. ANODE/CATHODE
 6. ANODE/CATHODE
 7. ANODE/CATHODE
 8. ANODE/CATHODE
 9. ANODE/CATHODE
 10. ANODE/CATHODE
 11. COMMON CATHODE
 12. COMMON ANODE
 13. ANODE/CATHODE
 14. ANODE/CATHODE

STYLE 8:
 PIN 1. COMMON CATHODE
 2. ANODE/CATHODE
 3. ANODE/CATHODE
 4. NO CONNECTION
 5. ANODE/CATHODE
 6. ANODE/CATHODE
 7. COMMON ANODE
 8. COMMON ANODE
 9. ANODE/CATHODE
 10. ANODE/CATHODE
 11. NO CONNECTION
 12. ANODE/CATHODE
 13. ANODE/CATHODE
 14. COMMON CATHODE

DOCUMENT NUMBER:	98ASB42565B	Electronic versions are uncontrolled except when accessed directly from the Document Repository. Printed versions are uncontrolled except when stamped "CONTROLLED COPY" in red.
DESCRIPTION:	SOIC-14 NB	PAGE 2 OF 2

onsemi and **ONSEMI** are trademarks of Semiconductor Components Industries, LLC dba **onsemi** or its subsidiaries in the United States and/or other countries. **onsemi** reserves the right to make changes without further notice to any products herein. **onsemi** makes no warranty, representation or guarantee regarding the suitability of its products for any particular purpose, nor does **onsemi** assume any liability arising out of the application or use of any product or circuit, and specifically disclaims any and all liability, including without limitation special, consequential or incidental damages. **onsemi** does not convey any license under its patent rights nor the rights of others.

MECHANICAL CASE OUTLINE PACKAGE DIMENSIONS



TSSOP-14 WB
CASE 948G
ISSUE C

DATE 17 FEB 2016

SCALE 2:1



NOTES:

- DIMENSIONING AND TOLERANCING PER ANSI Y14.5M, 1982.
- CONTROLLING DIMENSION: MILLIMETER.
- DIMENSION A DOES NOT INCLUDE MOLD FLASH, PROTRUSIONS OR GATE BURRS. MOLD FLASH OR GATE BURRS SHALL NOT EXCEED 0.15 (0.006) PER SIDE.
- DIMENSION B DOES NOT INCLUDE INTERLEAD FLASH OR PROTRUSION. INTERLEAD FLASH OR PROTRUSION SHALL NOT EXCEED 0.25 (0.010) PER SIDE.
- DIMENSION K DOES NOT INCLUDE DAMBAR PROTRUSION. ALLOWABLE DAMBAR PROTRUSION SHALL BE 0.08 (0.003) TOTAL IN EXCESS OF THE K DIMENSION AT MAXIMUM MATERIAL CONDITION.
- TERMINAL NUMBERS ARE SHOWN FOR REFERENCE ONLY.
- DIMENSION A AND B ARE TO BE DETERMINED AT DATUM PLANE -W-.

DIM	MILLIMETERS		INCHES	
	MIN	MAX	MIN	MAX
A	4.90	5.10	0.193	0.200
B	4.30	4.50	0.169	0.177
C	---	1.20	---	0.047
D	0.05	0.15	0.002	0.006
F	0.50	0.75	0.020	0.030
G	0.65 BSC		0.026 BSC	
H	0.50	0.60	0.020	0.024
J	0.09	0.20	0.004	0.008
J1	0.09	0.16	0.004	0.006
K	0.19	0.30	0.007	0.012
K1	0.19	0.25	0.007	0.010
L	6.40 BSC		0.252 BSC	
M	0°	8°	0°	8°

GENERIC MARKING DIAGRAM*



- A = Assembly Location
- L = Wafer Lot
- Y = Year
- W = Work Week
- = Pb-Free Package

(Note: Microdot may be in either location)

*This information is generic. Please refer to device data sheet for actual part marking. Pb-Free indicator, "G" or microdot "▪", may or may not be present. Some products may not follow the Generic Marking.



DOCUMENT NUMBER:	98ASH70246A	Electronic versions are uncontrolled except when accessed directly from the Document Repository. Printed versions are uncontrolled except when stamped "CONTROLLED COPY" in red.
DESCRIPTION:	TSSOP-14 WB	PAGE 1 OF 1

onsemi and onsemi are trademarks of Semiconductor Components Industries, LLC dba onsemi or its subsidiaries in the United States and/or other countries. onsemi reserves the right to make changes without further notice to any products herein. onsemi makes no warranty, representation or guarantee regarding the suitability of its products for any particular purpose, nor does onsemi assume any liability arising out of the application or use of any product or circuit, and specifically disclaims any and all liability, including without limitation special, consequential or incidental damages. onsemi does not convey any license under its patent rights nor the rights of others.

onsemi, **Onsemi**, and other names, marks, and brands are registered and/or common law trademarks of Semiconductor Components Industries, LLC dba "**onsemi**" or its affiliates and/or subsidiaries in the United States and/or other countries. **onsemi** owns the rights to a number of patents, trademarks, copyrights, trade secrets, and other intellectual property. A listing of **onsemi**'s product/patent coverage may be accessed at www.onsemi.com/site/pdf/Patent-Marking.pdf. **onsemi** reserves the right to make changes at any time to any products or information herein, without notice. The information herein is provided "as-is" and **onsemi** makes no warranty, representation or guarantee regarding the accuracy of the information, product features, availability, functionality, or suitability of its products for any particular purpose, nor does **onsemi** assume any liability arising out of the application or use of any product or circuit, and specifically disclaims any and all liability, including without limitation special, consequential or incidental damages. Buyer is responsible for its products and applications using **onsemi** products, including compliance with all laws, regulations and safety requirements or standards, regardless of any support or applications information provided by **onsemi**. "Typical" parameters which may be provided in **onsemi** data sheets and/or specifications can and do vary in different applications and actual performance may vary over time. All operating parameters, including "Typicals" must be validated for each customer application by customer's technical experts. **onsemi** does not convey any license under any of its intellectual property rights nor the rights of others. **onsemi** products are not designed, intended, or authorized for use as a critical component in life support systems or any FDA Class 3 medical devices or medical devices with a same or similar classification in a foreign jurisdiction or any devices intended for implantation in the human body. Should Buyer purchase or use **onsemi** products for any such unintended or unauthorized application, Buyer shall indemnify and hold **onsemi** and its officers, employees, subsidiaries, affiliates, and distributors harmless against all claims, costs, damages, and expenses, and reasonable attorney fees arising out of, directly or indirectly, any claim of personal injury or death associated with such unintended or unauthorized use, even if such claim alleges that **onsemi** was negligent regarding the design or manufacture of the part. **onsemi** is an Equal Opportunity/Affirmative Action Employer. This literature is subject to all applicable copyright laws and is not for resale in any manner.

PUBLICATION ORDERING INFORMATION

LITERATURE FULFILLMENT:

Email Requests to: orderlit@onsemi.com

onsemi Website: www.onsemi.com

TECHNICAL SUPPORT

North American Technical Support:

Voice Mail: 1 800-282-9855 Toll Free USA/Canada

Phone: 011 421 33 790 2910

Europe, Middle East and Africa Technical Support:

Phone: 00421 33 790 2910

For additional information, please contact your local Sales Representative