

Coin Supercapacitor



Application

- Backup power: RAM, detonator, car recorder, smart meter, vacuum switch, digital camera, motor drive
- Energy storage: intelligent three meters, UPS, security equipment, communication equipment, flashlights, water meters, gas meters, taillights, small appliances
- High current operation: electrified railway, smart grid control, hybrid vehicle, wireless transmission
- High-power support: wind power, locomotive start, ignition, electric cars, etc.



Standard test conditions:

The standard test conditions of this specification are standard atmospheric pressure, temperature 25 ° C, relative humidity less than 60%.

Product structure

This product is based on the principle of electric double layer capacitor. Internally, activated carbon is used as the positive and negative electrode, and the electrolyte is separated from the diaphragm by the two electrodes.

General specification

Rated discharge capacity(F 25 °C) ($\Delta V = 4.4V - 2.75V$)	470 mF
Capacity tolerance	-10 ... 20 %
Rated Voltage	5.5 V
Operating Temperature Min.	-25 °C
Operating Temperature Max.	70 °C
Maximum equivalent series resistance ESR (1KHz)	40 Ω

Performance index

Temperature characteristics	+70 °C $\Delta C/C$ $\leq 30\%$, ESR \leq Initial value(25 °C) -25 °C $\Delta C/C$ $\leq 50\%$, ESR ≤ 4 times initial value (25 °C)
High temperature load	+70 °C applied \leq rated voltage, after 1000h, $\Delta C/C$ $\leq 30\%$, ESR ≤ 4 times the specified value
High temperature without load	+70 °C, after 1000 \pm 4h, $\Delta C/C$ $\leq 30\%$, ESR ≤ 2 times the specified value
The steady state damp heat test	+40 °C, 90--95%RH, 240h, $\Delta C/C$ $\leq 30\%$, ESR ≤ 4 times the specified value
Cycle life Expectancy	Adding rated voltage, normal temperature cycle charge and discharge test 500,000 times $\Delta C/C$ $\leq 30\%$, ESR ≤ 4 times initial value(25 °C)

Coin Supercapacitor

Drawing

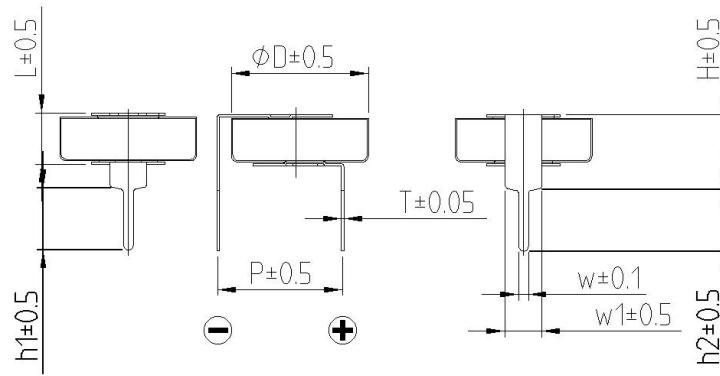

Size Size (ØD×L×H)	Pin distance (P)	Pin width (w1)	Positive pin length (h1)	Negative lead length (h2)
11.5×5×6.4 mm	10.5 mm	3 mm	5 mm	5 mm

Performance testing method

1) According to standard

QC/T 741-2014 – Vehicle super capacitor

DL/T 1652-2016 – Technical specifications for supercapacitors for electric energy metering

2) Test method capacitance

1. Constant current discharge method

2. Measuring circuit

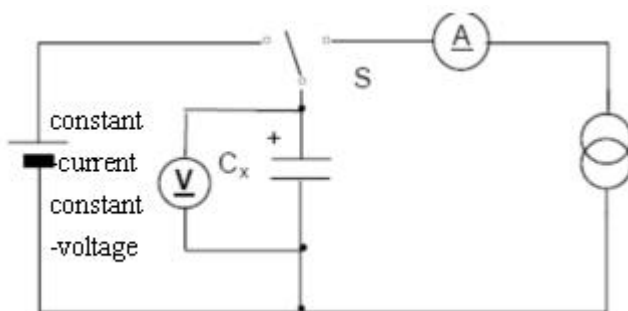

Constant current discharge device



-  d.c. ammeter
-  d.c. voltmeter
- S** changeover switch
- C_x** capacitor under test

Figure 1 – Circuit for constant current discharge method

Measuring method

- Setting the direct current voltage of constant current/constant voltage power supply as rated voltage (U_R)
- Setting the constant current value of the constant current discharge device, according to Table 2 specified
- Turn the switch S to the d.c. power supply, and unless otherwise specified in the individual standards, apply voltage and charge for 30 min after the constant current/ constant voltage power supply has achieved the rated voltage
- After charging for 30 min has finished, change over the switch S to the constant current discharge device, and discharge with a constant current
- Unless otherwise specified in the individual standards, measure the time t_1 and t_2 where the voltage between capacitor terminals at the time of discharge reduces from U_1 to U_2 as shown in Figure 2, and calculate the capacitance value by the following formula

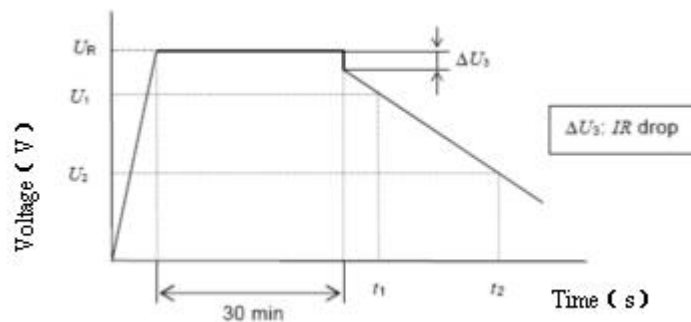

Figure 2 – Voltage characteristic between capacitor terminals

$$C = \frac{I \times (t_2 - t_1)}{U_1 - U_2}$$

C is the capacitance (F);

I is the discharge current (A);

U_1 is the measurement starting voltage (V);

U_2 is the measurement end voltage (V);

t_1 is the time from discharge start to reach U_1 (s);

t_2 is the time from discharge start to reach U_2 (s).

Discharge current I and decrease in voltage of discharge voltage U_1 , U_2 , according to table 1

Coin Supercapacitor

Discharge conditions

Table 1 – Discharge conditions

Classification	SE、 HE、 HT(Coin type product)	SP、 HP、 HT、 LR	Remarks
Application	Energy storage	Instantaneous power, power	$I_1 = \frac{C_R \times U_R}{3600}$
Charging time	30min	30min	
U1	80% of the charging voltage (0.8×UR)		
U2	50% of the charging voltage (0.5×UR)		
Remarks: CR is the nominal capacity of the supercapacitor in Farads (F); UR rated voltage in volts (V); I is the charge and discharge test current in amps (A); I1 is a supercapacitor 1 times charge and discharge current in amps (A)			

Equipment

- 1) ARBIN super capacitor test system
- 2) Linear DC stabilized voltage power supply
- 3) Constant current discharging device
- 4) Voltage recording device

Internal resistance

AC impedance method

Measuring circuit

As shown in the measurement circuit for testing.

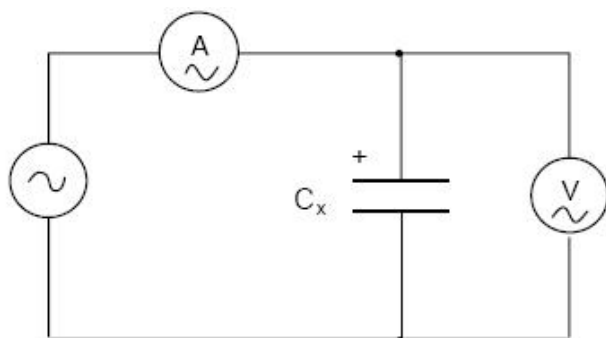



-  oscillator
-  a.c. ammeter
-  a.c. voltmeter
- C_x capacitor under test

Figure 4–Circuit for a.c. resistance method

Measuring method

The internal resistance R_a of a capacitor shall be calculated by the following formula:

$$R_a = \frac{U}{I}$$

R_a is the a.c. internal resistance (Ω)

U is the effective value of a.c. voltage (V r.m.s.)

I is the effective value of a.c. current (V r.m.s.)

The frequency of the measuring voltage shall be 1 kHz The a.c. current shall be from 1 mA to 10 mA
equipment: Internal resistance tester

Preauctions for use

Supercapacitors cannot be used in the following states:

- a) temperature above the nominal temperature

When the temperature of the capacitor exceeds the nominal temperature, it will cause the electrolyte to decompose, and the capacitor will heat up and the capacity will drop

Moreover, the internal resistance is increased and the life is shortened.

- b) voltage exceeding the rated voltage

When the capacitor voltage exceeds the nominal voltage, it will cause the electrolyte to decompose, and the capacitor will heat up and the capacity will drop

Moreover, the internal resistance is increased and the life is shortened. Therefore, reducing the voltage used can increase the service life.

- c) loading of reverse voltage or alternating voltage

2. Influence of ambient temperature on supercapacitors

The service life of supercapacitors is affected by the temperature of use. Under normal circumstances, the temperature of the supercapacitor is reduced by 10 °C, and the life of the supercapacitor is shortened by half. Try to use it in a low temperature environment below the maximum operating temperature. If it is used beyond the maximum operating temperature, the characteristics may deteriorate rapidly and be damaged.

The temperature of the supercapacitor should be determined not only by the temperature around the device, but also by the internal temperature. The radiant heat of the heating element (power transistor, resistor, etc.) in the device and the self-heating temperature caused by the ripple current are also confirmed. Also, do not install the heating element near the supercapacitor.

3. Please use the positive and negative signs of the capacitor correctly.
4. Please avoid using super capacitors in the following environments.

Precautions for use

- a) Environment where direct splashing water, salt water and oil are present, or in a dew condensation state, filled with gaseous oil or salt.
 - b) An environment filled with harmful gases (hydrogen sulfide, sulfurous acid, chlorine, ammonia, bromine, methyl bromide, etc.).
 - c) An environment where acidic and alkaline solvents are splashed.
 - d) Direct sunlight or dusty environment.
 - e) An environment that is subject to excessive vibration and shock.
5. In the welding process to avoid overheating the capacitor (1.6mm printed circuit board, welding should be 260 ° C, the time does not exceed 5s).
 6. Please avoid circuit wiring between the lead terminals of the supercapacitor or the solder joints of the connecting plates.
 7. When the overvoltage and the operating temperature range exceed the rated conditions, the pressure valve may act and the electrolyte may be ejected. Therefore, please adopt a design method that has taken into account this abnormal condition.
 8. In the case of rapid charge and discharge, a voltage drop due to internal impedance (also called IR drop) occurs at the start of charging and at the beginning of discharge. Therefore, use a design method that takes into account the magnitude of the voltage change.
 9. Power type large-capacity products (about 10F or more) If the terminal is short-circuited during charging, there will be hundreds of amps of current flowing, which is dangerous. Please do not install or disassemble while charging.
 10. Do not put the capacitor in the dissolved solder, only solder the solder on the guide pin of the capacitor. Do not allow the welding rod to contact the capacitor heat shrink tubing.
 11. Do not forcibly twist or tilt the capacitor after installation.
 12. When the supercapacitors are used in series, there is a voltage balance problem between the cells.

Art. Nr.

RND 150SE-5R5-D474VYH3E