

EVC080

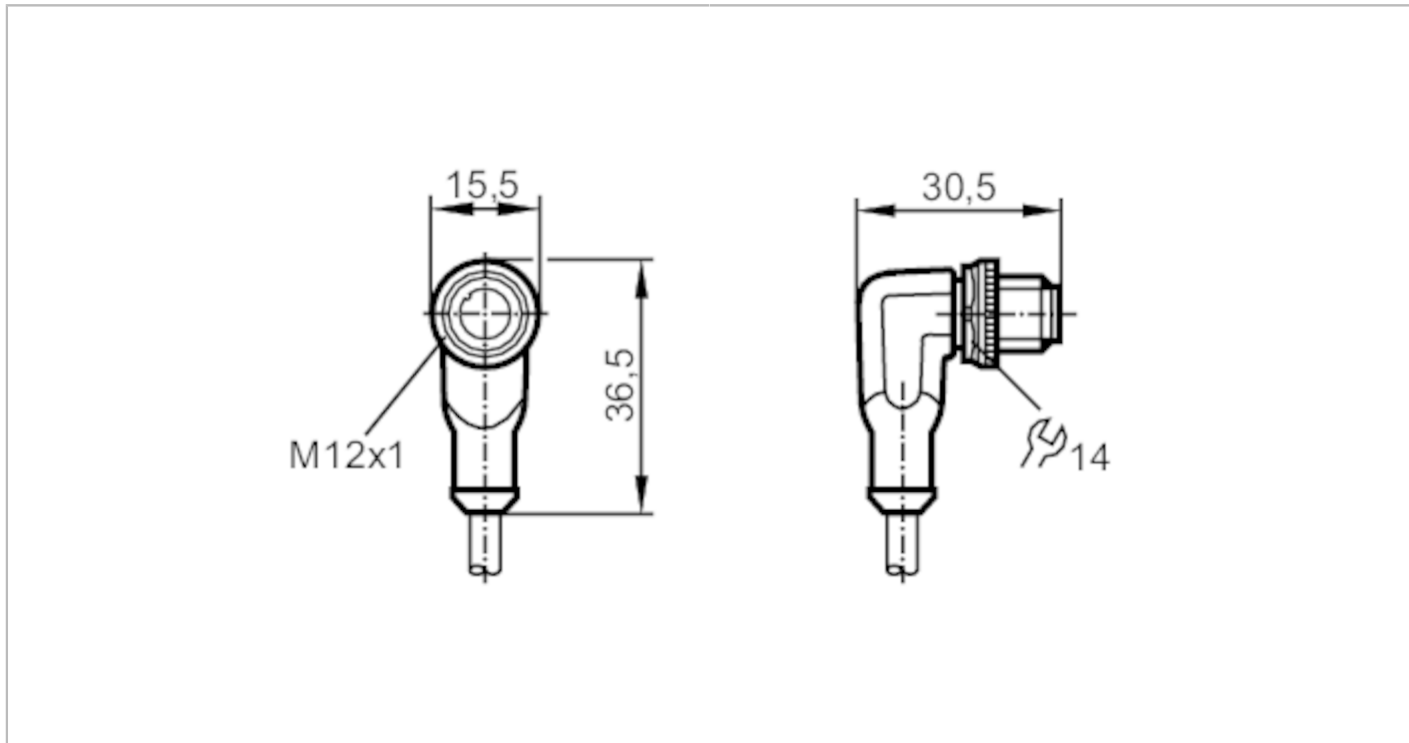

Connecting cable with plug

ASTAH040MSS0005H04



Application	
Special feature	Free from silicone; Halogen-free; Gold-plated contacts; Drag chain suitability
Free from silicone	yes
Electrical data	
Operating voltage [V]	< 250 AC / < 300 DC
Protection class	II
Max. current load total [A]	4
Operating conditions	
Ambient temperature [°C]	-25...90
Note on ambient temperature	cULus: ...75
Ambient temperature (moving) [°C]	-25...90
Note on ambient temperature (moving)	cULus: ...75
Protection	IP 65; IP 67; IP 68; IP 69K

EVC080



Connecting cable with plug

ASTAH040MSS0005H04

Mechanical data		
Weight [g]	155.7	
Dimensions [mm]	30.5 x 15.5 x 36.5	
Materials	electronics housing: TPU orange	
Material nut	brass, nickel-plated	
Drag chain suitability	yes	
Drag chain suitability	bending radius for flexible use	min. 10 x cable diameter
	travel speed	max. 3.3 m/s for a horizontal travel length of 5 m and max. acceleration of 5 m/s ²
	bending cycles	> 5 Mio.
	torsional strain	± 180 °/m

Remarks	
Notes	Please see the technical note under "Downloads"
Pack quantity	1 pcs.

Electrical connection
Cable: 5 m, PUR, Halogen-free, black, Ø 4.9 mm; 4 x 0.34 mm ² (42 x Ø 0.1 mm)

Electrical connection - plug
Connector: 1 x M12, angled; Locking: brass, nickel-plated; Contacts: gold-plated; Tightening torque: 0.6...1.5 Nm



EVC080



Connecting cable with plug

ASTAH040MSS0005H04

Connection

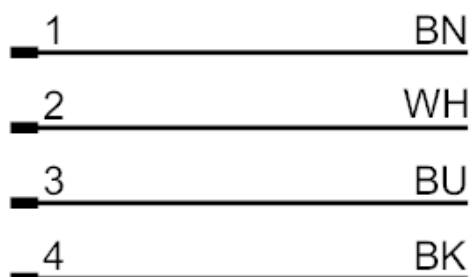

Core colours :

- BK = black
- BN = brown
- BU = blue
- WH = white

Diagrams and graphs

characteristic line for derating



Derating $I_{max} * 0.8$ (DIN EN 60512-5-2)

X Ambient temperature [°C]

Y Current [A]