

AS Crimping machine L 8



EN Operating manual

Before putting the machine into operation, read the operating manual!
Keep manual for future use.

Fabrication number

Art.No. 4050.452



RITTAL GmbH & Co. KG
Auf dem Stützelberg
POB 1662
D-35726 Herborn
Germany



Phone + 49(0)2772 505-0
Fax + 49(0)2772 505-2319
info@rittal.de
www.rittal.de

März 2016, Version 1.0

When contacting the manufacturer for any information,
please have the machine type and the fabrication number available.
(See type plate on the machine)

© 2016 Rittal GmbH & Co.KG, All rights reserved.

Table of contents

1	GENERAL	1
1.1	INTRODUCTION	1
1.2	TARGET GROUP	1
1.3	RESERVATION OF THE RIGHT OF MODIFICATION AND COPYRIGHT	1
1.4	TRAINING AND INSTRUCTION	2
1.5	UNAUTHORIZED MODIFICATION AND SPARE PARTS	2
1.6	TRANSPORT	2
2	SAFETY	3
2.1	INTENDED USE	3
2.2	PROHIBITED USE	3
2.3	DANGER OF THE MACHINE	4
2.4	USE RISKS	4
2.5	SOURCE OF DANGER	4
2.6	SAFETY INSTALLATIONS	4
2.7	SIGNS AND SYMBOLS	5
2.7.1	WARNING SIGNS	5
2.7.2	MANDATORY SIGNS	6
2.7.3	INFORMATION SIGNS	6
2.8	REMAINING RISKS	7
2.9	SECURITY MEASURES AT THE INSTALLATION LOCATION	7
2.10	NOTES FOR THE OPERATOR	8
2.11	NOISE HAZARD	8
3	PRODUCT DESCRIPTION	9
3.1	TECHNICAL DATA	9
3.2	GENERAL VIEW OF THE MACHINE	10
4	INSTRUCTION MANUAL	11
4.1	PUTTING INTO OPERATION	11
4.2	STARTING THE MACHINE	11
4.3	MENU	12
4.4	WIRE FEEDING	13
5	TOOLS	15
5.1	FERRULE FEEDING	15
5.1.1	SETTING OVERVIEW	15
5.2	STARTING DEVICE	16
5.3	STRIPPING BLADES AND ECCENTRIC	17
6	MAINTENANCE	19
6.1	MAINTENANCE INSTRUCTIONS	19
6.2	DAILY MAINTENANCE	20
6.3	WEEKLY MAINTENANCE	21
6.4	MONTHLY MAINTENANCE	25
6.5	QUARTERLY MAINTENANCE	28
6.6	AS NEEDED	29

7	TROUBLESHOOTING	31
7.1	THE MACHINE DOES NOT START	31
7.2	NO START AFTER FEEDING THE WIRE	31
7.3	THE WIRE IS ONLY STRIPPED.....	31
7.4	INCREASING REFUSE	31
7.5	ERROR MESSAGES.....	32
8	PNEUMATIC DIAGRAM	35
9	ELECTRICAL DIAGRAM	37
10	SPARE PARTS AND ACCESSORIES.....	39
11	DISPOSAL	41

1 General

1.1 Introduction

This instruction manual contains: important notes, how to use the machine safely and appropriately. The operating manual helps you to avoid dangers, as well as reduce repair costs and down time.

By following the operation manual, you increase the product reliability and life time of the machine.

This operation manual must be available to persons operating the machine.
Persons, working with the machine, must read and follow the operation manual.

This manual includes:

- ◆ Putting the machine into operation
- ◆ Operation of the machine
- ◆ Troubleshooting
- ◆ Maintenance (maintenance / service)
- ◆ Transportation

To ensure safety, this machine is only intended for use as described in this manual.

The Rittal GmbH & Co.KG GmbH, Auf dem Stützelberg, D-35745 Herborn
is following called manufacturer.

1.2 Target group

This operating manual is designed for the normal worker.

1.3 Reservation of the right of modification and copyright

The copyright, as well as all rights in the event of grant or utility model registration in this operating manual remains by the manufacturer.

The listed rules, guidelines, engineer standards and so on in this operating manual are to conform to the information during the elaboration.

Regulations and drawings of technical parts may neither completely nor partly be duplicated, spread, utilized or informed to others for other unauthorized purposes (e.g. competition).

If the operator desires the regulations and drawings of technical parts outlined above, this requires expressed, written approval from the management of the manufacturer.

The manufacturer reserves the right to technical changes and improvements at any time.

This applies to all data, details, notes and illustrations of this operation manual.

A claim to change and improvement of already delivered tools is impossible.

This operating manual was created with reasonable care.

1.4 Training and instruction

- ◆ Only trained and qualified personnel are allowed to handle this machine.
- ◆ The responsibilities of the personnel operating, changing tools and maintaining this machine must be well defined.
- ◆ Only the manufacturer or authorized service workshops are entitled to repair these products.

1.5 Unauthorized modification and spare parts

- ◆ Modifications, mounting and reconstructions at the control can lead to unpredictable dangers.
- ◆ Any kind of modification and manipulation at the tools are forbidden. If the operator makes any modifications or manipulations of this kind, machine safety is no longer guaranteed. The manufacturer takes no liability for defects and consequential damages which occur due to the aforementioned measures.
- ◆ Use only original spare parts and authorized accessories from the manufacturer. The use of other parts excludes liability for damages every description (consequential damages, too).

1.6 Transport

For the transportation always use the complete original packing.



For service and repair work, the machine must be sent in with all accessories.

2 Safety

2.1 Intended use

The machine is electropneumatic driven crimping machine. This machine was only designed for stripping insulated wires according to DIN EN 60228 and crimping for loose ferrules with insulating collar (size 0.5 -2.5 mm² (AWG20-14) / length 8). For this reason the machine was constructed for only this exact purpose.

The intended use includes compliance to:

- ◆ All notes in the operating manual
- ◆ Documentation of the supplier products.
- ◆ All notes on maintenance

Any other use is not permitted.

The description in **paragraph 3.1 “Technical data”**, are to keep and follow as well as in the original documentation possibly the supplier products.

An abnormal use of the machine is not known by manufacturer.

For originated defects, because of an uncorrected purpose of use or by a not intended use the manufacturer takes no responsibility.

2.2 Prohibited use

- ◆ Removing information signs or warning signs.
- ◆ Opening the machine during operation.
- ◆ Using the machine when there are obvious visible defects or damages.
- ◆ Inserting any kind of object to the feeding funnel, which is not designed for this use.

2.3 Danger of the machine

The findings of the hazard analysis are that the machine is conforming to guidelines and can classify as safe.

As with any machine, risks still remain and they cannot be eliminated by construction.

See 2.8 *Remaining risks*.

2.4 Use risks

The user is only allowed to eliminate disorders were the cover must not remove.

Before you change the tools or spare parts, you have to unplug and disconnect the machine from the power supply system.

2.5 Source of danger

Before performing maintenance and cleaning on the machine, the machine must be switched off from the power supply system (e.g. Disconnect from the power supply, switch off the fuse)



Never remove the safety installations or put out of control by changes of the machine.

2.6 Safety installations

The safety installations are designed to protect the worker.

The operator undertakes to do yearly a check of the safety installations.

Cover Should the removal of the cover be necessary, take care that the earth wire is connected after re-closing the machine.
The removal of the cover is only to be performed by skilled workers or instruted personnel.

Switching power supply (SELV) The switching power supply protects from dangerous voltages.
It is not possible for more than 60 V-AC or 110 V-DC to go through the machine.

It is not allowed in any way to remove or make changes to the machine that interferes with the safety installations.

2.7 Signs and Symbols

The operating manual uses the following important signs and names for safety instructions.

2.7.1 Warning signs



Signal word!

This warning sign describes a possible danger.

The non-observance of these signs can cause injuries or property damages.

This sign is often used in combination with mandatory signs.



WARNING! Danger by electrical voltage!



CAUTION!

Warning for cutting injuries of the hand.

2.7.2 Mandatory signs



Consider the operating manual!
Before putting the machine into operation read the operating manual carefully.



This sign marks important operation instruction and application instructions.
The non-observance of the notes can produce damages of the tool and other material values from the operator.



Unplug main switch



Use the machine only in dry conditions.

2.7.3 Information signs

Earth conductor

This label is placed at the earthing screw.



The protective earthing is a method, which is safeguards in a fault against dangerous voltage and electric shock.

The method protective earthing is performed by an earth conductor.

The connection is created by a rubber connector with earth conductor contact.

The earth conductor "PE" (green/yellow insulation only in Germany) is used for this safety installation.

2.8 Remaining risks

With observance of all safety notes and warning information, remaining risks are still possible with operation of the tool.

This machine is state of the art and accredits safety-related rules. However, dangers can occur with use of the tool.

Errors which could influence the safety should be eliminated immediately, if necessary contact the manufacturer with the fabrication number.



WARNING!

Electric shock risk when working with conducting parts.

⇒ *Work on electric parts should only be performed by skilled personnel.*

2.9 Security measures at the installation location

The machine must be installed securely on a table.

→ *A fallen machine represents a great risk of injury.*



Internal instructions and controls should ensure that the work place and the environment are clean and clear.

2.10 Notes for the operator



- ⇒ **The duty of the operator is to write a directive.**
 - ⇒ **The operator is to do yearly a check of the safety installations.**
 - ⇒ **Use only original fuses with declared amperage.**
-

- ◆ Knowledge of the local regulations relating to safety and accident prevention.
- ◆ All notes on the tool have to be kept in readable condition; if necessary you have to exchange them.
- ◆ Inform the manufacturer immediately, if the machine and the application becomes unsafe.
- ◆ Change machine parts immediately, if they are not in good order and condition.
- ◆ Only use the machine for the intended use.
- ◆ Before you put the machine into operation the machine must be in a safe condition.

2.11 Noise hazard

The equivalent continuous weighted sound pressure level of the stripping machine enclosure ≤ 70 dB(A).

No ear protection is necessary for the operation of this machine.

3 Product description

3.1 Technical data

Designation	Unit
Feeding length	27 mm + stripping length
Cross section	0.5 – 2.5 mm ² (20-14 AWG)
Crimp form	Trapezium 
Drive	Electro pneumatic
Voltage	100 - 240 VAC
Frequency	50 / 60 Hz
Power consumption	100 VA
Fuse (filter-module)	2x T2AH250V
Operating pressure	5.5 bar
Air consumption per cycle	approx. 0.9 L
IP-Code	IP 20
Cycle time	approx. 1.0 s
Continuous sound level	≤70 dB(A)
Dimensions (wxdxh)	390 x 330 x 460 mm
Colour	RAL 9003
Weight	31 kg
Interface	Touch-Display

Operating environment	Unit
Transport temperature	-25°C to +55°C
Environmental temperature	+5°C to 40°C
Operating temperature	+10°C to 45°C
Max. operating height	2000m absolute altitude
Relative humidity	50% to 40°C (no condensation)
	90% to 20°C (no condensation)
Contamination level	2
Pressure safety installation	85% to 110%

3.2 General view of the machine

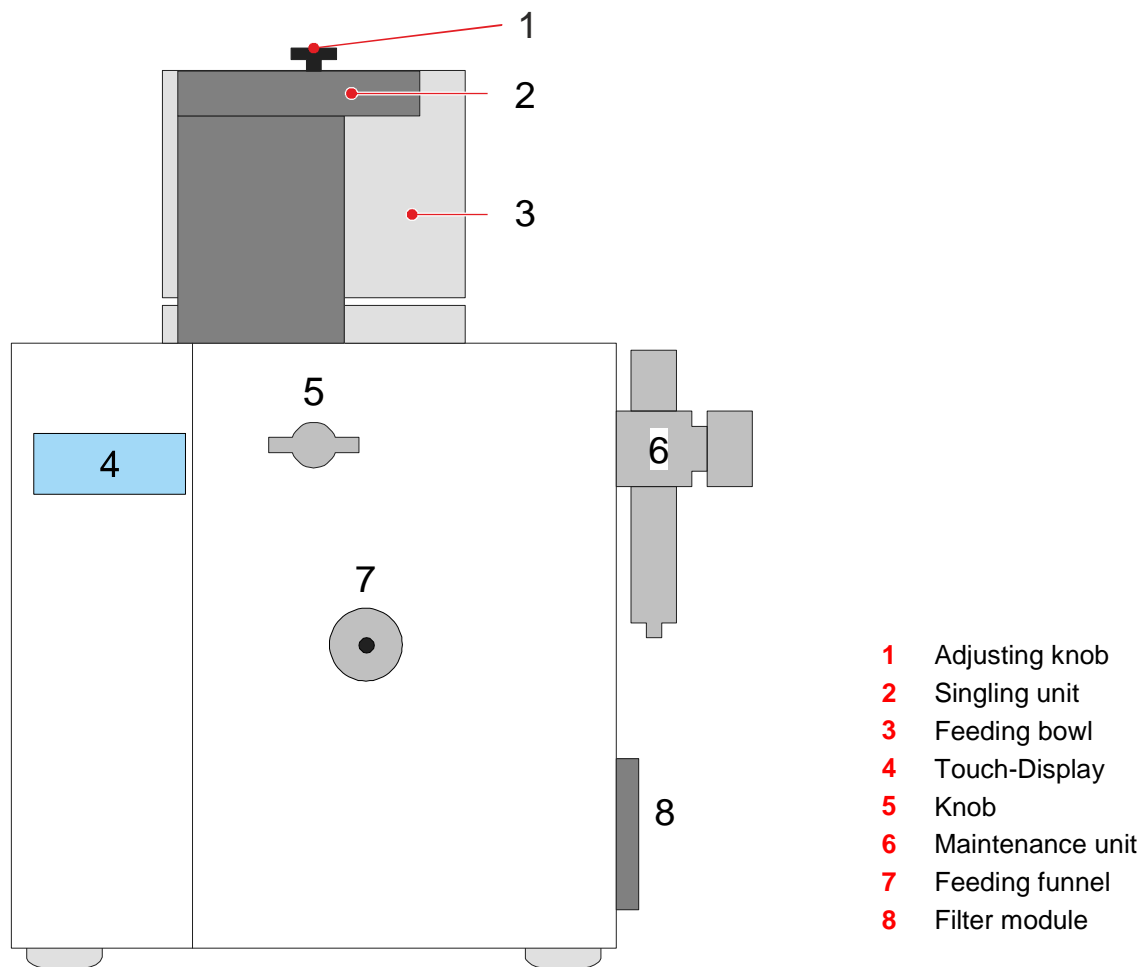

Figure 1: General view



Bild / Picture 1: Innenansicht / Interior view

4 Instruction manual

4.1 Putting into operation

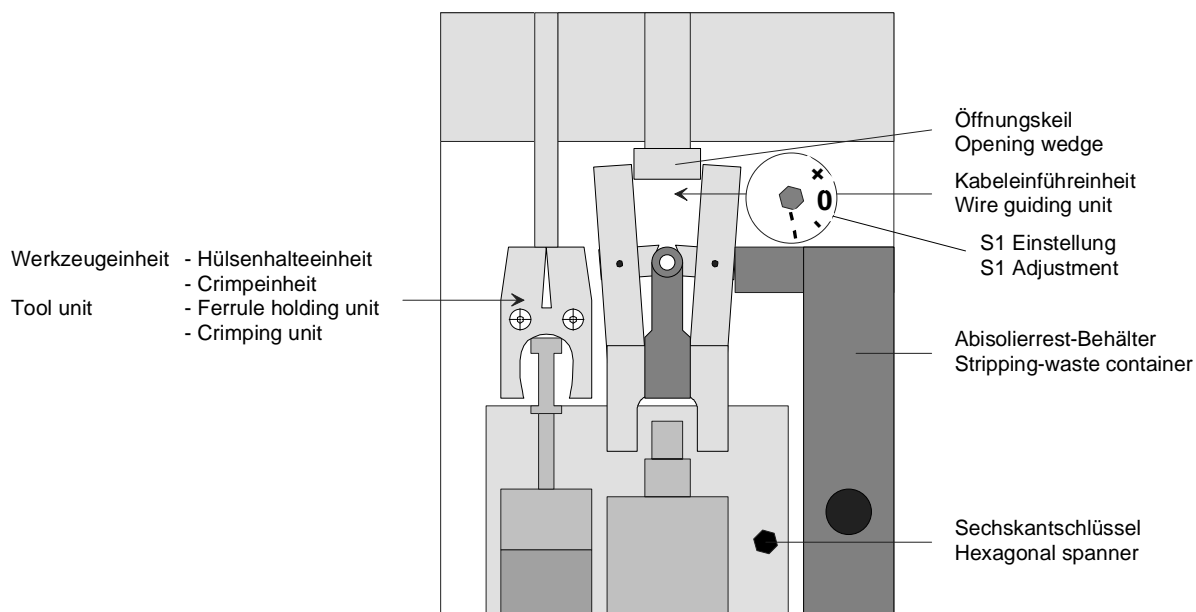

⚠ CAUTION!

The electrical data on the type plate must conform with the electrical power supply.



NOTE !

Clean the wires before processing from sliding agent (e.g. talcum powder)

- ⇒ The machine is provided with a pneumatic maintenance unit (filter and controller) and can be connected with the compressed-air supply.
- ⇒ Connect the main cable between the machine and the electrical power supply.

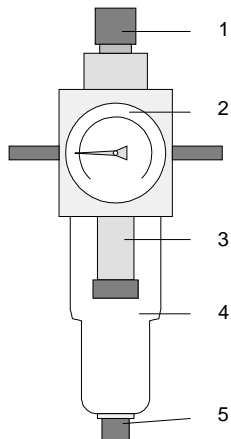

- | | |
|---|----------------|
| 1 | Adjusting knob |
| 2 | Pressure gauge |
| 3 | Filter element |
| 4 | Tank |
| 5 | Manual outflow |

Figure 2: Maintenance unit

4.2 Starting the machine

Switch on the main switch on the filter module

Menu 1 appears on the display.

4.3 Menu

  up or down  select

1. Operating menu

Ready/Strip/Crimp VC: %
 Status Power vibrating conveyor

Daily piece number ( 5 s → delete)

Error Message S: 1/0 (step)
 first number stripping-crimping
 second number ferrule feeding

2. Power of the vibrating conveyor

Indication in %  increase
  decrease

120V → VC-power approx. 54%

230V → VC-power approx. 27%

 select → Cursor flashes

Adjust the value with   buttons.

 to conform

Loading the feeding path:

If the  button is pressed the VC-value rises until the maximum VC-value. After you release the button, past 3 sec. the value of the power is reset to the saved VC-value.

3. Program stripping

0 stripping and crimping
 1 only stripping

After turning on the machine the program stripping = 0 is selected.

If the program stripping = 1 is selected, this is shown in the operating menu.

4. Piece counter and operating time

total: total piece number

Cycle: operating time of one cycle

Service: Show the piece number which can be done until the next Service is become due.

5. Test inputs

No., status (I or 0)

Name of the assembly part

6. Test outputs

No., status (I or 0)

Name of the assembly part

For simulation: C = 0, E = 1

7. General Data

8. Step time

9. PC-Data

10. Language

German

English

French

Italian

Netherland

4.4 Wire feeding

The wire triggers the working cycle by inserting into the feeding funnel.



The wire has to be cut off straight and may not have any bends or bows.

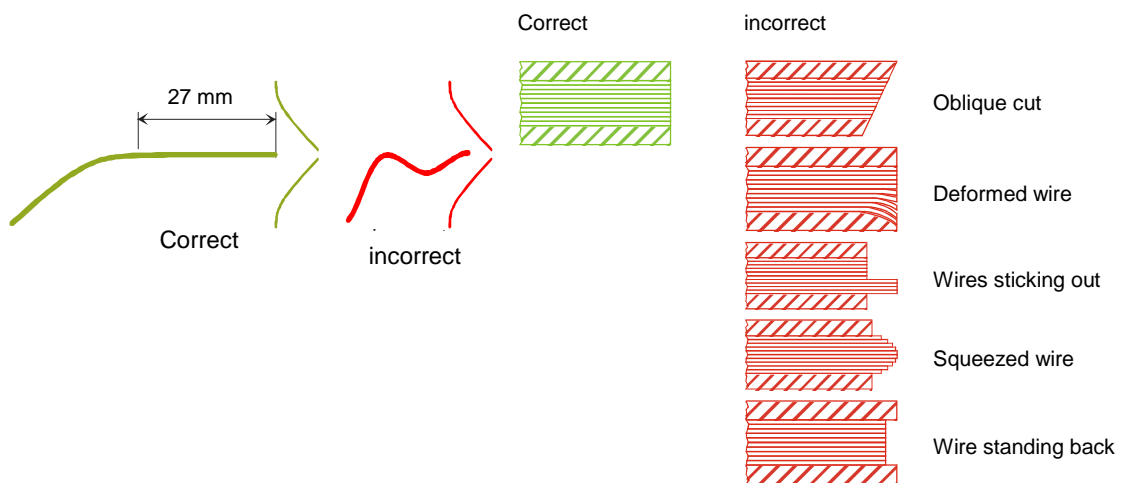

Graphic 1: Wire feeding



5 Tools

5.1 Ferrule feeding

The ferrule feeding consists of the feeding bowl, the singling unit and the feeding tube.

- Release the screw in the middle of the feeding bowl, turn the feeding bowl counterclockwise and lift it for exchange.
- To adjust the singling unit pull the knob upwards and turn it.
- Screw on the feeding bowl.
- Fill the feeding bowl with ferrules.
- Select program 2.
- To load the feeding path press  up to the desired power of the vibrating conveyor and hold it. When you let off the key the value of the power is reset to the saved value.
- Adjust the supplying speed in order to ensure a sufficient supply of ferrules.
- The first wire is only stripped.

5.1.1 Setting overview:

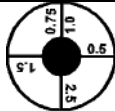
 Aderendhülse / Ferrule	 Schwingförderoberteil / Feeding bowl	 Vereinzelungseinheit / Singling unit
0,5 / 8 N	1	0,5
0,5 / 8 S	1	0,75 – 1,0
0,75 / 8 N	1	0,75 – 1,0
0,75 / 8 S	1	0,75 – 1,0
1,0 / 8 N	1	0,75 – 1,0
1,0 / 8 S	1 / 2	1,5
1,5 / 8 N	1 / 2	1,5
1,5 / 8 S	2	2,5
2,5 / 8 N	2	2,5
2,5 / 8 S-XS	2	2,5

5.2 Starting device

- Open the front panel.
- Push the tool unit to the back.
- Set the adjustment wheel of the starting device on position “0”, “+”, “-“ or “--“.
- “0” is the standard-feeding length, “+” extended the feeding length (turn in clockwise direction), “-“ reduces the feeding length. “--“ reduces the feeding length even more to prevent strand overhang (turn in counterclockwise direction).

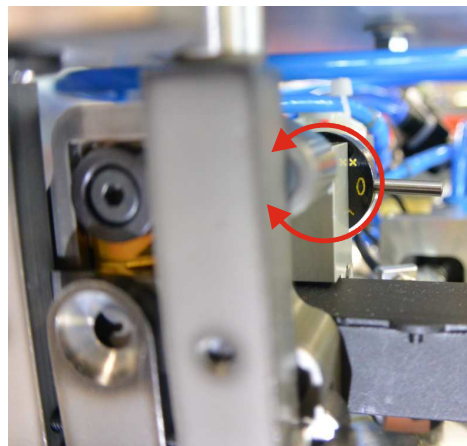

Adjustment of the starting device

5.3 Stripping blades and Eccentric



CAUTION!
Blades are sharp.
Beware of cutting damages to the hand.
 ⇒ *Do not touch the blade.*

1. Remove the two fixing screws.
2. Release the eccentric.
3. Remove the cover.
4. Remove blades with tweezers.
5. Assembly of the new stripping blades in reversed order
6. Pending on the strength and the thickness of the insulation the eccentric of the stripping blades have to be adjusted in "+" or "-" direction.
7. For less cut in position the eccentric in "+" direction and for more cut in position the eccentric in "-" direction.

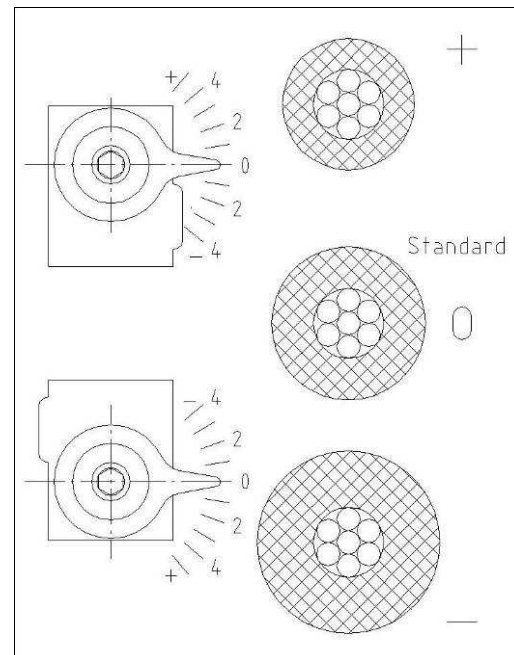
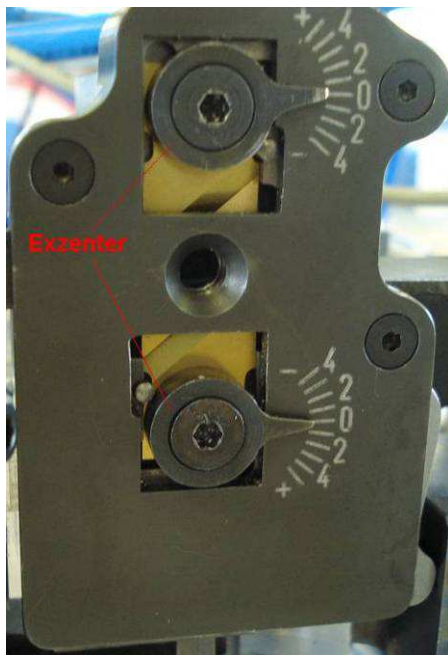

Picture 2: Stripping module

6 Maintenance

**NOTE!**

Before maintenance, the machine must be disconnected from the power supply.

⇒ *Otherwise a risk of injury threatening!*

6.1 Maintenance instructions

- The manufacturer recommends arranging an aftersales service for the machine every 400,000 cycles.
- Do not clean the interior of the machine with compressed air.
- Do not use spray oil or spray grease.
- If possible use silicone- or PTFE-oil (Teflon-oil).
- Use grease, which is applicable for bearings and sliding surfaces.
- The display and touch screen are made of plastic and they do not may come into contact with hard objects. The surface of the touch screen can be cleaned with a soft cloth without the use of solvents.

6.2 Daily maintenance

Clean out stripping-Waste-Container.

- Open front panel.
- Pull out stripping waste container and empty it.
- Reinsert the container.
- Close front panel.

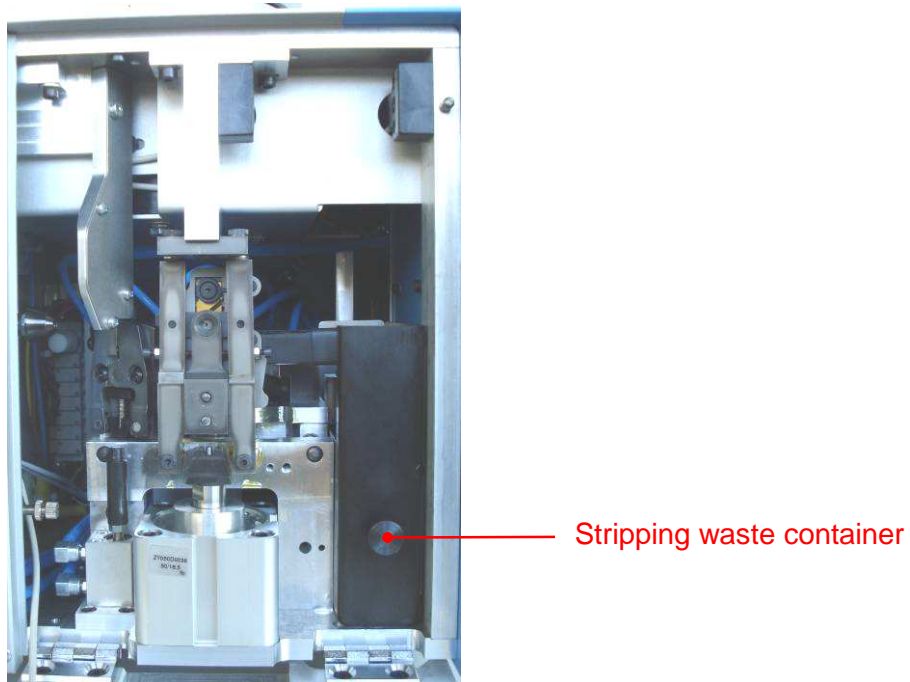

Picture 3: Stripping-waste container

6.3 Weekly maintenance

Blow out feeding bowl

- Remove the Feeding bowl, therefore unscrew the handle, turn the feeding bowl counter-clockwise and lift it up.
- Emptying commodity out of the feeding bowl.
- Blow feeding bowl out carefully.
- Set bowl back on the machine, turn it clockwise to the stop and tighten the handle

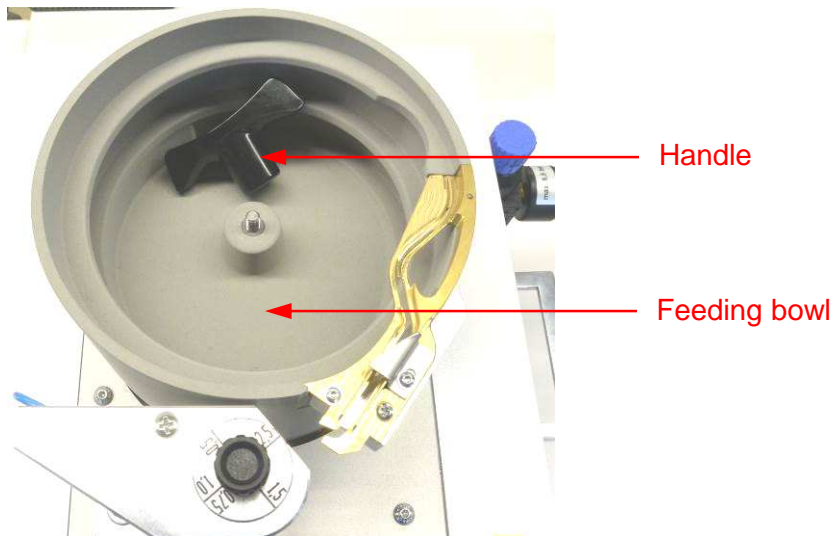

Picture 4: Feeding bowl

Clean machine interior

- Open Frontpanel.
- Pull out strippingwaste container.
- Clean machine interior by using paint brush and vacuum-cleaner.

DO NOT USE COMPRESSED AIR FOR CLEANING THE INTERIOR OF THE MACHINE

Clean wire holder

- Clean wire holder by using a paint brush and ethyl alcohol.



Bild / Picture 5: Litzenfixierung / wire holder

Clean holding tong

- Open front panel.
- Holding tong is located on the front panel.
- Clean holding tongs by using a paint brush.

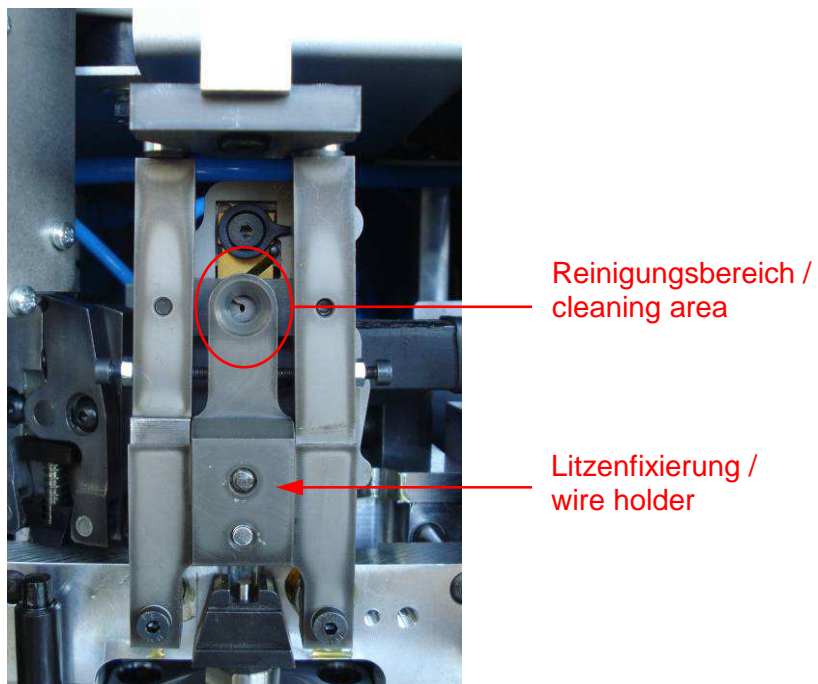

Bild / Picture 6: Haltezange / holding tong

Clean stripping unit

- Turn tool unit to the right side.
- Clean insertion hole of the stripping unit with caution by using a soft, applicable brush (e.g. pipecleaner) and ethyl alcohol.
- In any case do not lubricate the stripping unit.

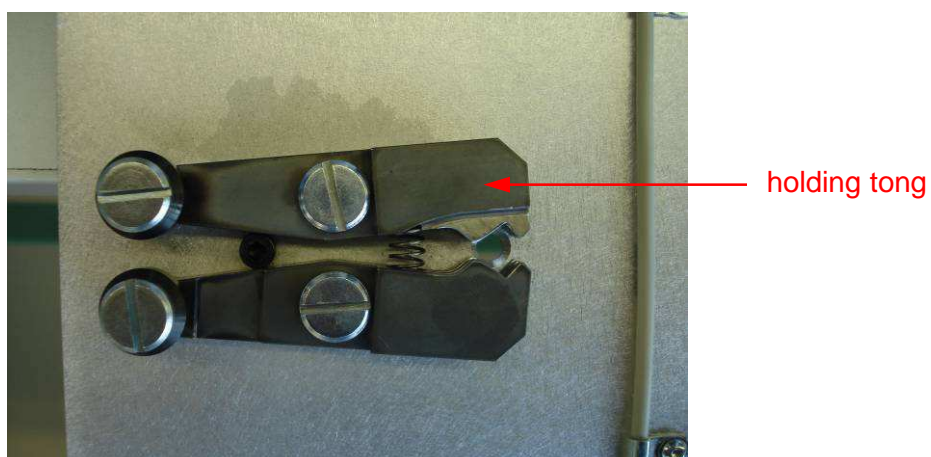

Bild / Picture 7: Abisoliereinheit / stripping unit

Control stripping blades

- Turn tool unit to the right side.
- Control blades optical for abrasion or damage by moving the stripping slide upwards.
- To reset the blade position, push the tool unit to the right on the bedstop.

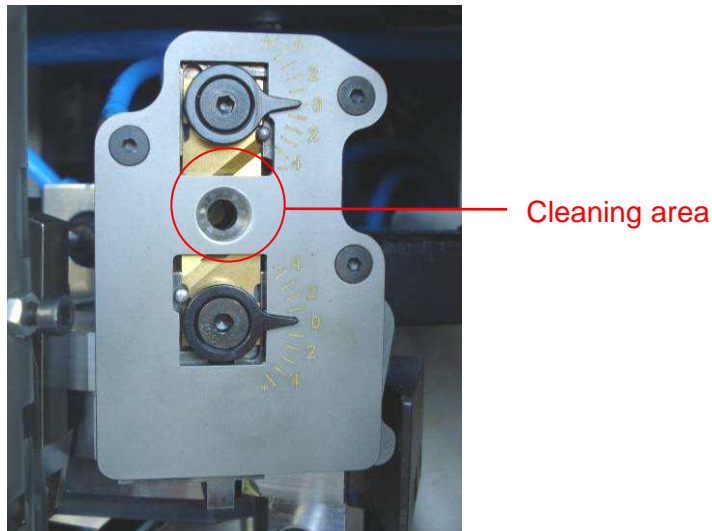

Bild / Picture 8: Abisoliereinheit / stripping unit

Control pneumatic adjustment

- The pressure setting at the maintenance unit must be between 5.0 and 5.5 bar for a correct function of the machine.

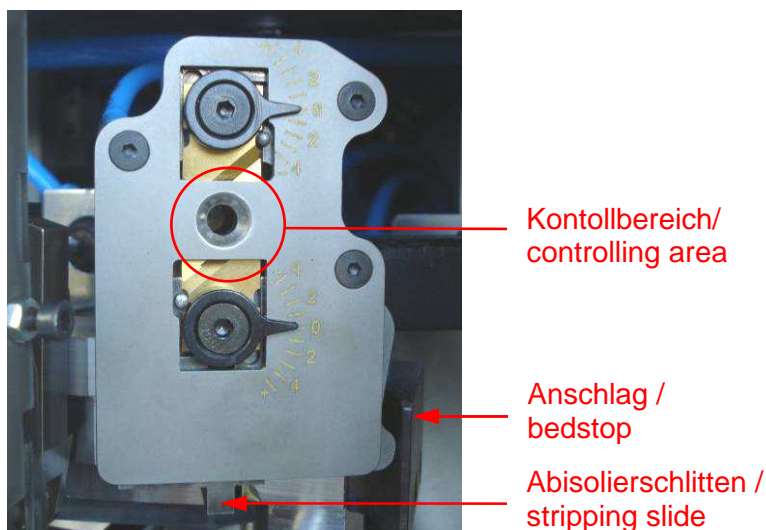

Bild / Picture 9: Druckluftwartungseinheit / pneumatic maintenance unit

6.4 Monthly maintenance

Wire holder

- Check the rollers of the wire holder for smoothness.
- Oil the pivot points of the rollers lightly.
- Oil the pivot points of the wire holder lightly.

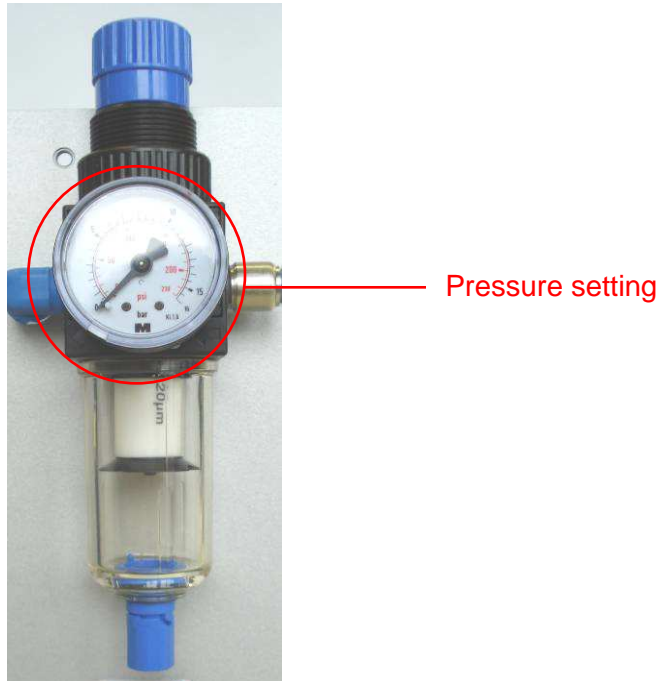
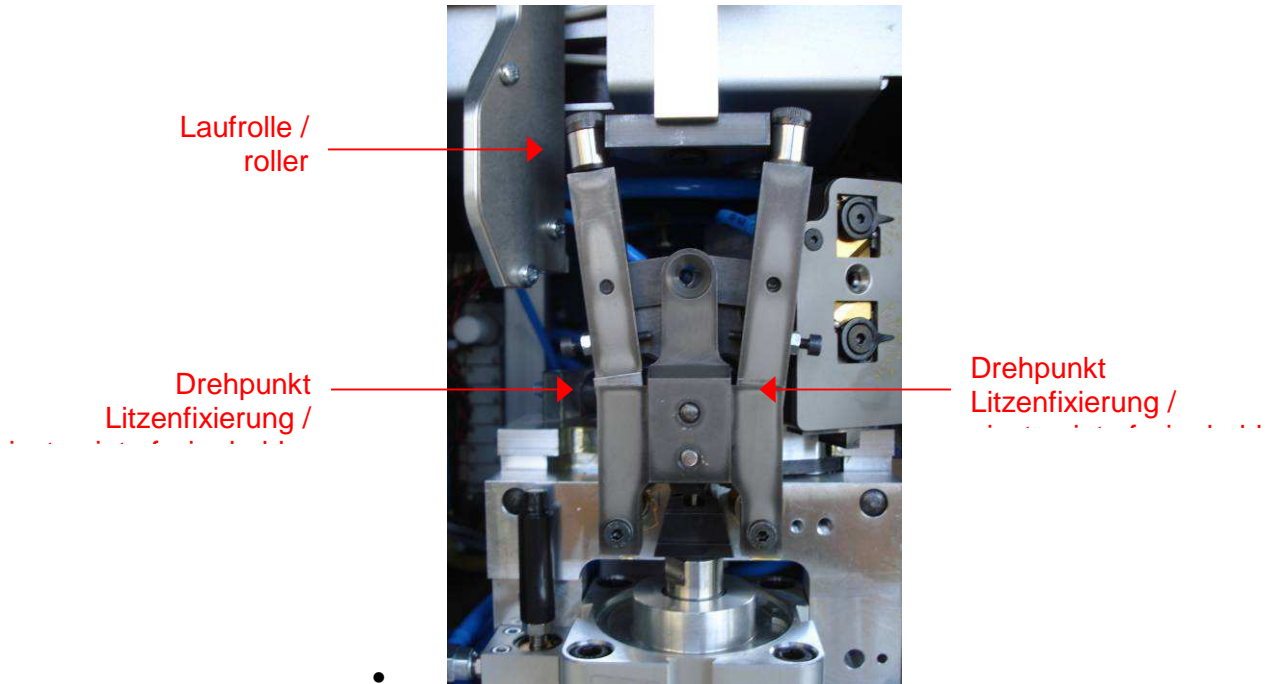

Holding tong

Oil the pivot point and the contact surface of the holding tong lightly.



Bild / Picture 10: Haltezange / holding tong

Ferrule holding tong and crimping tool

- Turn tool unit to the right side.
- Loosen the right screw of the wire holder ½ turn.
- Give a small impact on the head of the screw.
- Turn out the right screw completely.
- Pull out the wire holder in front.
- Make sure that the ring-spacer remains on the shaft.
- Pull tool unit to the front.
- Check the rollers of the ferrule holding tong for smoothness.
- Check the rollers of the crimping tool for smoothness.
- Oil the pivot points of the rollers lightly.
- Oil the guiding pin lightly.
- Insert the wire holder. Make sure, that the guiding shaft nest in the drilling hole of the wire holder.
- Tighten right screw.

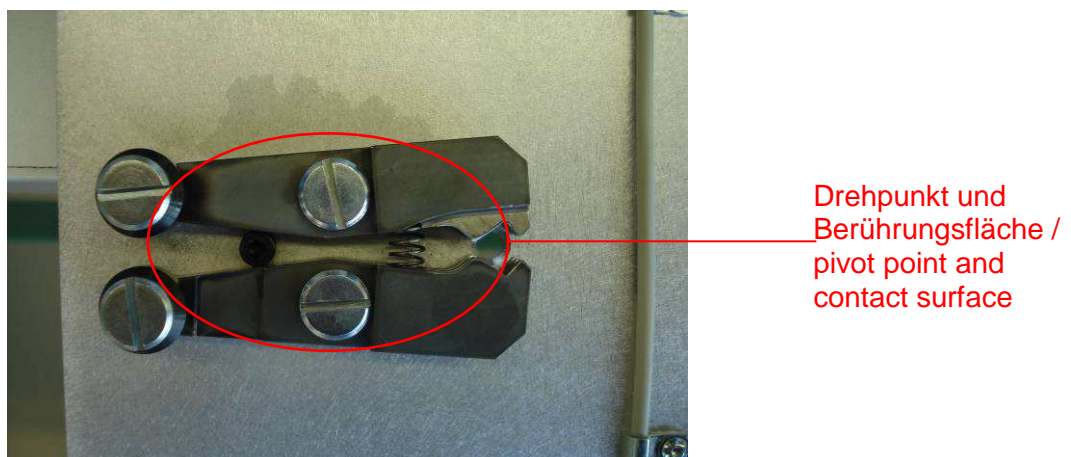
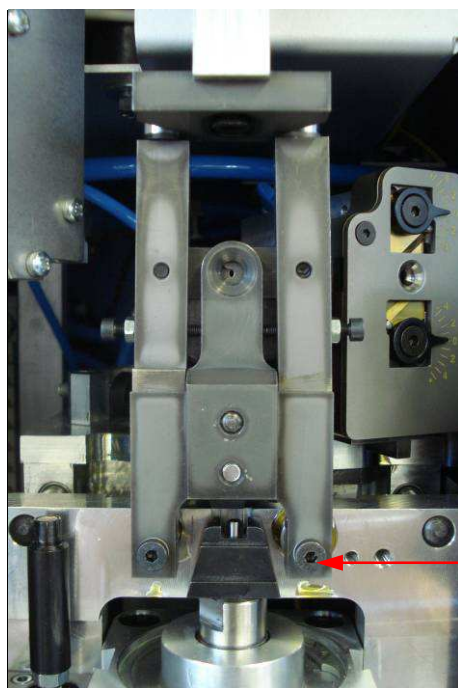

Rechte Schraube /
right screw

Bild / Picture 11: Hülsenhaltezange & Crimpwerkzeug / ferrule holding tong & crimping tool

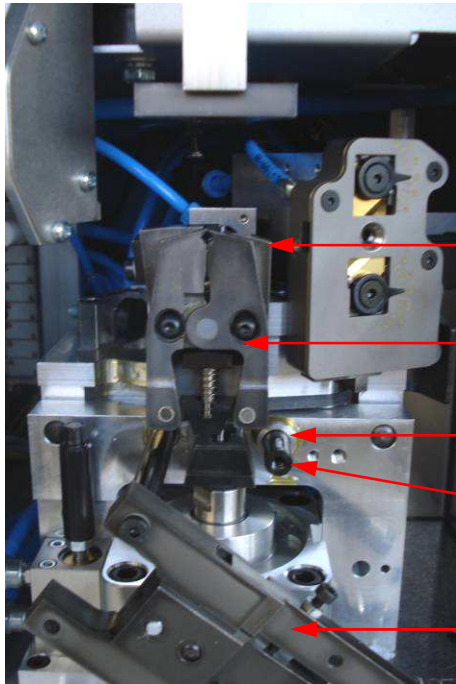

Crimpwerkzeug /
crimping tool

Hülsenhalte-
zange /
ferrule holding
tong

Distanzring /
ring spacer

Führungswelle /
guiding shaft

Litzenfixierung /
wire holder

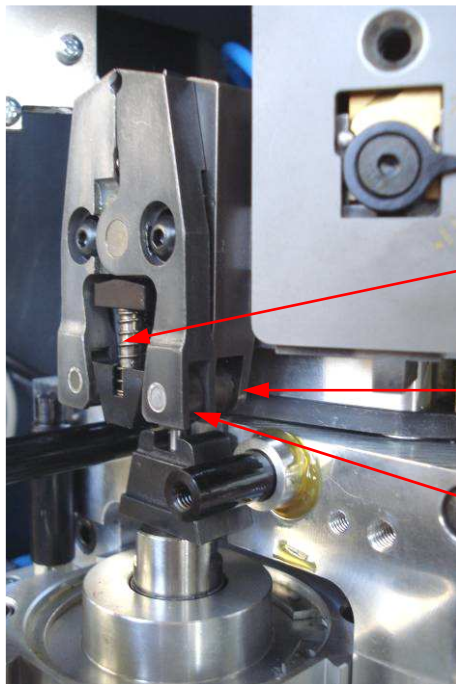

Führungsstift /
guiding pin

Laufrolle
Crimpwerkzeug /

Laufrolle Hülsenhalte-
zange/
roller ferrule holding
tong

Bild / Picture 12: Hülsenhalte-
zange & Crimpwerkzeug /
ferrule holding tong &
crimping tool

6.5 Quarterly maintenance

Pivoting slide

- Pull out the wire holder in front.
- Lubricate the contact surface by using a brush lightly with grease.

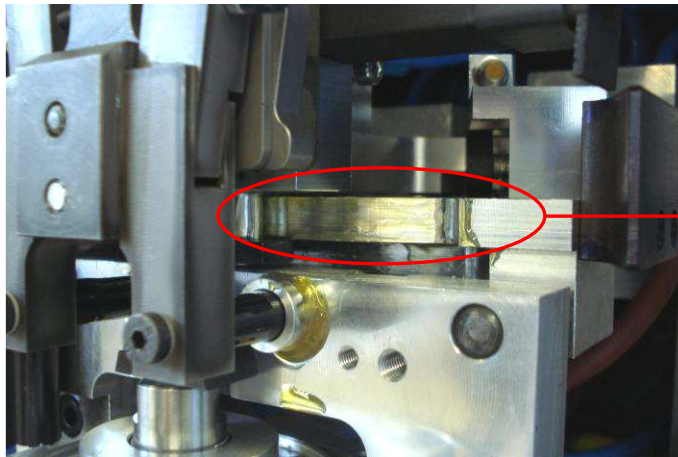

Berührungsfläche /
contact surface

Bild / Picture 13: Schwenkschlitten / pivoting slide

6.6 As needed

Pneumatic maintenance unit

- Let off the condensed water. Therefor push the drain screw to the top.
- The tank can be cleaned with water. To remove the tank, disconnect the air-supply.
- Attention: clean tank only with water.
- The filter element can be unscrewed for cleaning. Put it into purifying agent (benzine or petroleum) wash it out and dry it.



Bild / Picture 14: Druckluftwartungseinheit / pneumatic maintenance unit

7 Troubleshooting

7.1 The machine does not start

The electrical supply is disturbed

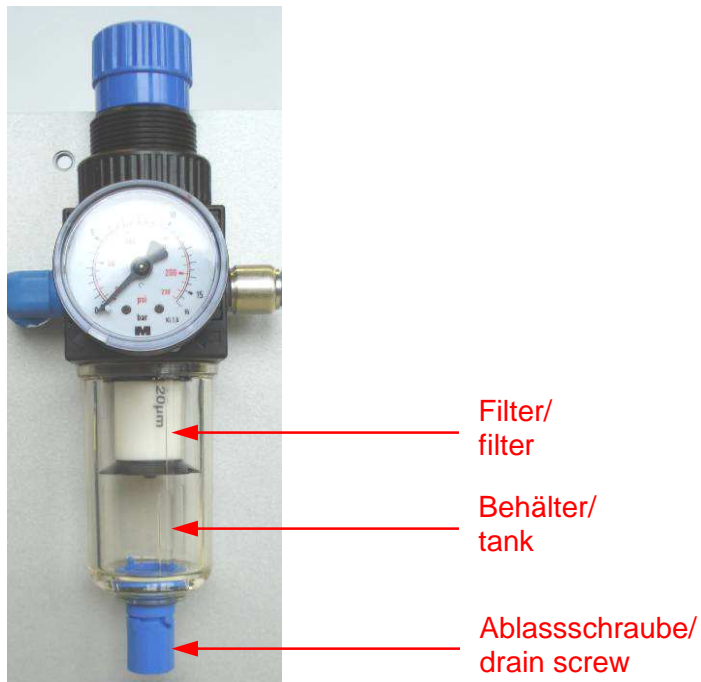
- ⇒ Check the main cable and the fuses

7.2 No start after feeding the wire

The starting sensor (S1) is blocked by stripping waste.

- ⇒ Press short once the Touch-Display „ Hand cycle“

The wire was incorrectly fed.

- ⇒ Feed the wire as described in chapter „ Fehler! Verweisquelle konnte nicht gefunden werden.“

7.3 The wire is only stripped

Program 3 “stripping” is selected

- ⇒ Correct the selection.

7.4 Increasing refuse

The stripping-blades are damaged or incorrectly mounted.

- ⇒ Correct or change the blades.

Stripping waste between the tool-unit and right limit stop.

- ⇒ Take out the stripping waste.

A second ferrule is located in the ferrule holding unit.

- ⇒ Take out the ferrule.

The stripping-waste container is full.

- ⇒ Empty the stripping-waste container.

7.5 Error messages

The error messages are shown on the display. By pressing **E** the error message is deleted.

"no op.voltage +15"
operating voltage +15V failed
"no op.voltage +24V"
operating voltage +24V failed

"inp.24V short c."
Short-circuit fault + 24 V
"A1 / 2 -short c."
short-circuit output 1 or 2
"A3 / 4 -short c."
short-circuit output 3 or 4
"A5 / 6 -short c."
short-circuit output 5 or 6
"A7 / 8 -short c."
short-circuit output 7 or 8
"A9 / 10 -short c."
short-circuit output 9 or 10
"A11 / 12 -short c."
short-circuit output 11 or 12

"VC-err.amplifier"
AUSF_02 amplifier-error
"VC-alert tempr."
AUSF_02 warning temperature on limit range
"VC-error tempr."
AUSF_02 shut down, temperature to high
"VC-RS485 Tim.Out"
AUSF_02 time out, check interface

"VC-error 230V"
AUSF_02 230V missed
"VC-error 115V"
AUSF_02 115V missed
"VC-reserve"
AUSF_02 reserve
"VC-not ready"
AUSF_02 not ready, error present

"error frontpl. K1"
Switch S 6 faulty
Error on closing the front panel, press the "Enter key" for 4 s.
"error frontpl. K2"
Switch S 6 faulty
Error on closing the front panel, press the "Enter key" for 4 s.
"frontplate open"
Close the front plate
"feeding error"
feeding VC disturbed
control feeding tube

"S1-start = 0"
S1 faulty

"S1-start = 1"
S1 faulty

"S2-Crimp.clos.= 0"
Check S2 and Y2

"S2-Crimp.clos.= 1"
Check S2 and Y2

"S3-stripposit.= 0"
Check S3 and Y3

"S3-stripposit.= 1"
Check S3 and Y3

"S4-Toolslide front = 0"
Check S4 and Y1

"S4-Toolslide front = 1"
Check S4 and Y1

"S5-Toolslide back = 0"
Check S5 and Y1

"S5-Toolslide back = 1"
Check S5 and Y1

"LS10-fer.missing"
ferrule is missing, check S10

"LS10-fer. present.=1"
ferrule exists, check S10

"ex.start n. ready"
externe start not ready

"error data vers"
Incorrect data-version by data transmission with PC

"error USB-cable"
USB-cable not plugged

"error time out"
Incorrect dataversion
interruption while data transmission

8 Pneumatic diagram

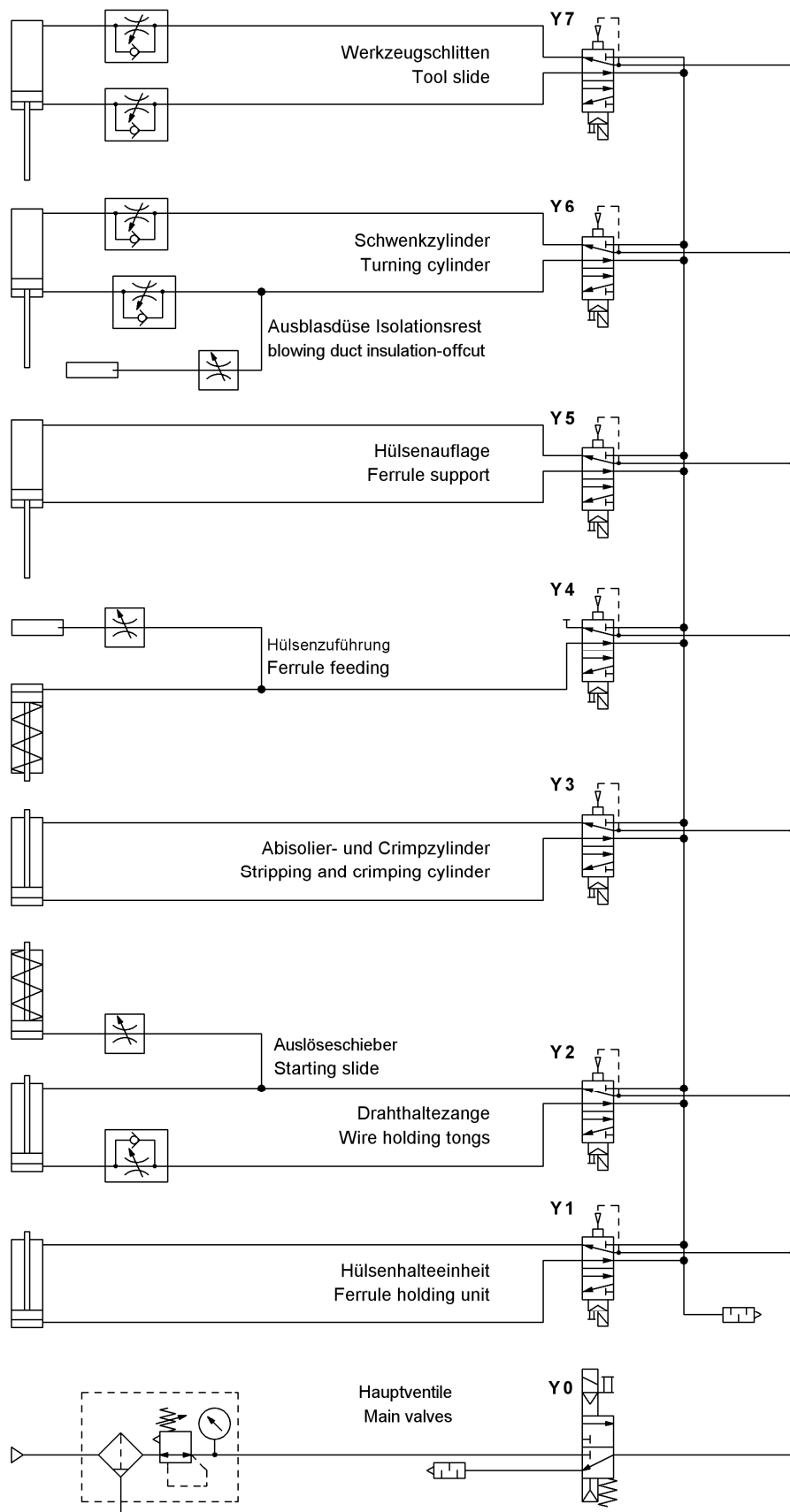

9 Electrical diagram

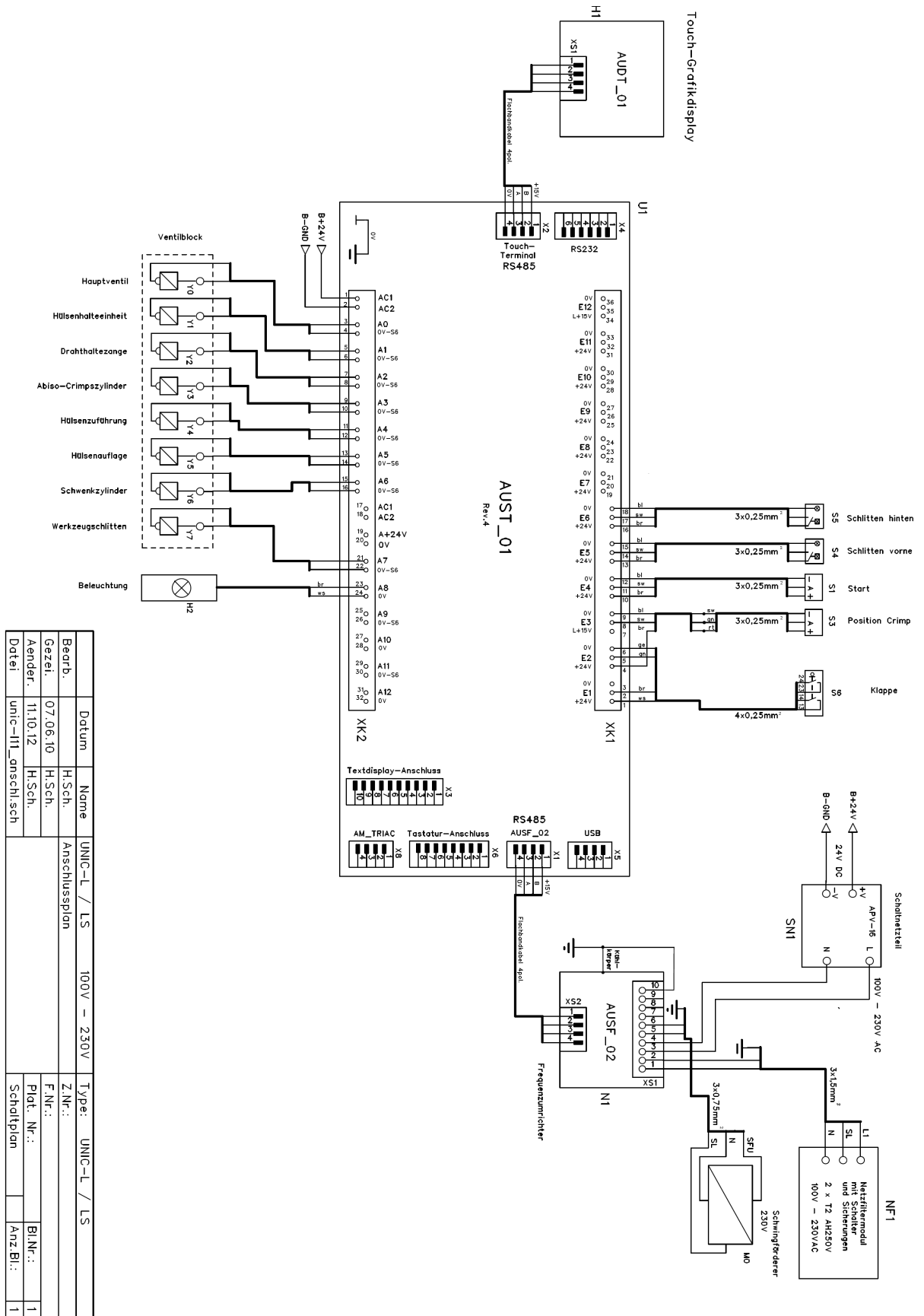

Bearb.	Datum	Name	UNIC-L / LS	100V - 230V	Type:	UNIC-L / LS
Gezei.	07.06.10	H.Sch.	Anschlussplan		Z.Nr.:	
Änder.	11.10.12	H.Sch.			Plat. Nr.:	
Datei	unic-III_anschsch				Schaltplan	Anz.Bli.: 1

10 Spare parts and accessories

Designation	No.
AS Replacement for stripping-knife titan	4050466
AS Ferrules 0,5 mm ² length 8mm	4050730
AS Ferrules 0,75 mm ² length 8mm	4050731
AS Ferrules 1,0 mm ² length 8mm	4050732
AS Ferrules 1,5 mm ² length 8mm	4050733
AS Ferrules 2,5 mm ² length 8mm	4050734
AS Ferrules 0,5 mm ² length 8mm AWG	4050742
AS Ferrules 0,75 mm ² length 8mm AWG	4050743
AS Ferrules 1,0 mm ² length 8mm AWG	4050744
AS Ferrules 1,5 mm ² length 8mm AWG	4050745
AS vibration conveyor 0,5 -1,0 mm ²	4050467
AS vibration conveyor 1,5 -2,5 mm ²	4050468
In case of an order declare serial number of the machine.	

11 Disposal

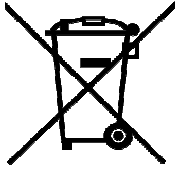

It is not allowed to dispose the machine in the domestic waste.
The disposal of the machine should be done professional and environmental manner.



