

## Ball Casters • screwable, plain bearing

22752.0584



### Product Description

For positioning and aligning of workpieces.  
Because of the slide bearing, the ball can roll permanently, and the surface of the workpiece is protected.  
At temperatures > 20°C, the carrying figure decreases linearly. (Example: at 90°C the load bearing capacity is max. 60%)

### Material

**Bearing**  
• plastic

**Ball**  
• Stainless steel, hardened

**Screw**  
• Stainless steel 1.4305

### More information

### Notes

Special types on request.

### Drawing

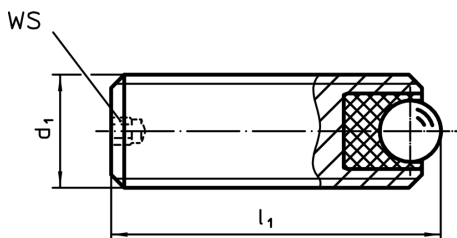

### Order information

Dimensions			WS	static carrying figure $C_0$	Tightening torque max.	Temperature		Weight	Art. No.
$d_1$	$l_1$	ball diameter				min.	max.		
[mm]			[mm]	[N]	[Nm]	[°C]		[g]	
stainless steel									
M8	20	3.5	1.5	336	0.28	-50	90	5.5	22752.0584

### Application example

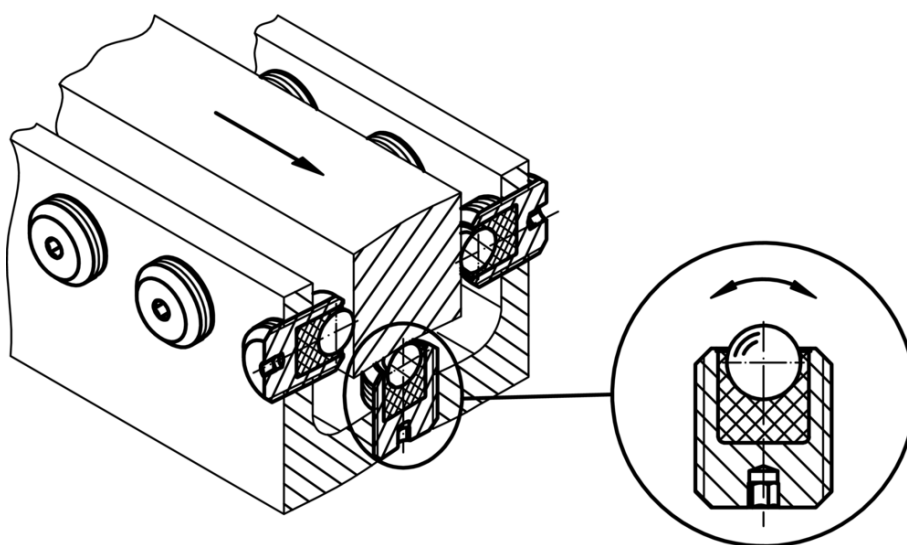

## Compliance

### RoHS compliant

Compliant according to Directive 2011/65/EU and Directive 2015/863

### Does not contain SVHC substances

No SVHC substances with more than 0.1% w/w contained - SVHC list [REACH] as of 10.06.2022

### Does not contain Proposition 65 substances

No Proposition 65 substances included  
<https://www.P65Warnings.ca.gov/>

### Free from Conflict Minerals

This product does not contain any substances designated as "conflict minerals" such as tantalum, tin, gold or tungsten from the Democratic Republic of Congo or adjacent countries.