

PLEASE CHECK WWW.MOLEX.COM FOR LATEST PART INFORMATION

Part Number: **0430450618**
Status: **Active**
Overview: Micro-Fit 3.0 Connector System Product Family
Description: Micro-Fit 3.0 Vertical Header, 3.00mm Pitch, Dual Row, 6 Circuits, with Solder Tab, Tin, Glow-Wire Capable, Black

Documents:

3D Model	Product Specification TS-46235-001-001 (PDF)
Drawing (PDF)	Packaging Specification PK-70873-05XX-003 (PDF)
Product Specification PS-43045 (PDF)	Test Summary 430450004-TS-000 (PDF)
Product Specification PS-43045-001 (PDF)	RoHS Certificate of Compliance (PDF)
Product Specification TS-43045-001-001 (PDF)	Product Literature (PDF)

Agency Certification

CSA	LR19980
UL	E29179

General

Product Family	PCB Headers
Series	<u>43045</u>
Application	Power, Wire-to-Board
Comments	""""""""High Temperature Square Pin Solder Type<P><P>This Molex product is manufactured from material that has the following ratings, tested by independent agencies:. a) A Glow Wire Ignition Temperature (GWIT) of at least 775 deg C per IEC 60695-2-13.. b) A Glow Wire Flammability Index (GWFI) above 850 deg C per IEC 60695-2-12.and hence complies with the requirements set out in the International Standard IEC 60335-1 5th edition - household and similar electrical appliances - safety, section 30 Resistance to heat and fire. <P><P> The customers using this product must determine its suitability for use in their particular application through testing or other acceptable means as described in end-product glow-wire flammability test standard IEC 60695-2-11 and any applicable product end-use standard(s). <P> If it is determined during the customer's evaluation of suitability, that higher performance is required, please contact Molex for possible product options. """"""""

Overview	<u>Micro-Fit 3.0 Connector System Product Family</u>
Product Literature Order No	987650-5984
Product Name	Micro-Fit 3.0
UPC	800754371353

Physical

Breakaway	No
Circuits (Loaded)	6
Circuits (maximum)	6
Color - Resin	Black
Durability (mating cycles max)	30
Flammability	94V-0
Glow-Wire Capable	Yes
Mated Height	17.64mm
Material - Metal	Brass
Material - Plating Mating	Tin

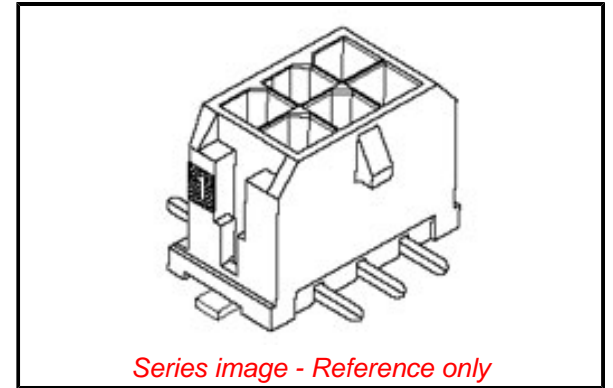

Series image - Reference only

EU ELV

Not Relevant

EU RoHS

Compliant

REACH SVHC

Not Contained Per - ED/61/2018 (27 June 2018)

Halogen-Free

Status

Low-Halogen

For more information, please visit [Contact US](#)

China ROHS

ELV

RoHS Phthalates

China RoHS

Green Image

Not Relevant

Not Contained

Search Parts in this Series

43045 Series

Mates With

Micro-Fit 3.0 Receptacle Housing 43025

Micro-Fit 3.0 Cable Assembly 245132

Micro-Fit 3.0 TPA Receptacle Housing 172952

Material - Plating Termination	Tin
Material - Resin	High Temperature Thermoplastic
Net Weight	1.220/g
Number of Rows	2
Orientation	Vertical
PCB Locator	Yes
PCB Retention	Yes
PCB Thickness - Recommended	1.60mm
Packaging Type	Embossed Tape on Reel
Pitch - Mating Interface	3.00mm
Plating min - Mating	0.254µm
Polarized to PCB	Yes
Shrouded	Fully
Stackable	No
Surface Mount Compatible (SMC)	N/A
Temperature Range - Operating	-40° to +105°C
Termination Interface: Style	Surface Mount

Electrical

Current - Maximum per Contact	8.5A
Voltage - Maximum	600V

Solder Process Data

Duration at Max. Process Temperature (seconds)	030
Lead-free Process Capability	REFLOW
Max. Cycles at Max. Process Temperature	003
Process Temperature max. C	260

Material Info

Reference - Drawing Numbers

Packaging Specification	PK-70873-05XX-003
Product Specification	PS-43045, PS-43045-001, TS-43045-001-001, TS-46235-001-001
Sales Drawing	SD-43045-007-001
Symbol/Footprint Data	SYM-43045-0618
Test Summary	430450004-TS-000

This document was generated on 10/26/2018

PLEASE CHECK WWW.MOLEX.COM FOR LATEST PART INFORMATION