



Figure can vary

Part no.: 68002316
MLC520R30-1650
Safety light curtain receiver



Contents

- Technical data
- Dimensioned drawings
- Electrical connection
- Circuit diagrams
- Operation and display
- Suitable transmitters
- Part number code
- Notes
- Accessories

Technical data

Basic data	
Series	MLC 500
Device type	Receiver
Contains	2x BT-NC sliding block
Application	Hand protection
Functions	
Function package	Standard
Functions	Contactor monitoring (EDM) Start/restart interlock (RES) Transmission channel changeover
Characteristic parameters	
Type	4 , IEC/EN 61496
SIL	3 , IEC 61508
SILCL	3 , IEC/EN 62061
Performance Level (PL)	e , EN ISO 13849-1
PFH _D	7.73E-09 per hour
Mission time T _M	20 years , EN ISO 13849-1
Category	4 , EN ISO 13849
Protective field data	
Resolution	30 mm
Protective field height	1,650 mm
Optical data	
Synchronization	Optical between transmitter and receiver
Electrical data	
Protective circuit	Overvoltage protection Short circuit protected
Performance data	
Supply voltage U _B	24 V , DC , -20 ... 20 %
Current consumption, max.	150 mA
Fuse	2 A semi time-lag
Inputs	
Number of digital switching inputs	3 Piece(s)
Switching inputs	
Type	Digital switching input
Switching voltage high, min.	18 V
Switching voltage low, max.	2.5 V
Switching voltage, typ.	22.5 V
Voltage type	DC

Outputs

Number of safety-related switching outputs (OSSDs) 2 Piece(s)

Safety-related switching outputs

Type	Safety-related switching output OSSD
Switching voltage high, min.	18 V
Switching voltage low, max.	2.5 V
Switching voltage, typ.	22.5 V
Voltage type	DC
Current load, max.	380 mA
Load inductivity	2,000 µH
Load capacity	0.3 µF
Residual current, max.	0.2 mA
Residual current, typ.	0.002 mA
Voltage drop	1.5 V

Safety-related switching output 1

Assignment	Connection 1, pin 5
Switching element	Transistor , PNP

Safety-related switching output 2

Assignment	Connection 1, pin 6
Switching element	Transistor , PNP

Timing

Response time	15 ms
Restart delay time	100 ms

Connection

Number of connections 1 Piece(s)

Connection 1

Type of connection	Connector
Function	Machine interface
Thread size	M12
Material	Metal
No. of pins	8 -pin

Cable properties

Permissible conductor cross section, typ.	0.25 mm ²
Length of connection cable, max.	100 m
Permissible cable resistance to load, max.	200 Ω

Mechanical data

Dimension (W x H x L)	29 mm x 1,716 mm x 35.4 mm
Housing material	Metal , Aluminum
Lens cover material	Plastic / PMMA
Material of end caps	Diecast zinc
Net weight	1,800 g
Housing color	Yellow, RAL 1021
Type of fastening	Groove mounting Mounting bracket Mounting on Device Column Swivel mount

Operation and display

Part no.: 68002316 – MLC520R30-1650 – Safety light curtain receiver

Type of display	7-segment display LED
Number of LEDs	2 Piece(s)

Environmental data

Ambient temperature, operation	-30 ... 55 °C
Ambient temperature, storage	-30 ... 70 °C
Relative humidity (non-condensing)	0 ... 95 %

Certifications

Degree of protection	IP 65
Protection class	III
Certifications	c CSA US c TÜV NRTL US S Mark TÜV Süd
Vibration resistance	50 m/s ²
Shock resistance	100 m/s ²
US patents	US 6,418,546 B

Classification

Customs tariff number	85365019
eCl@ss 8.0	27272704
eCl@ss 9.0	27272704
ETIM 5.0	EC002549
ETIM 6.0	EC002549

Dimensioned drawings

All dimensions in millimeters

Calculation of the effective protective field height $H_{PFE} = H_{PFN} + B + C$



H_{PFE} Effective protective field height = 1678 mm

H_{PFN} Nominal protective field height = 1650 mm

A Total height = 1716 mm

B 19 mm

C 9 mm

Part no.: 68002316 – MLC520R30-1650 – Safety light curtain receiver

R Effective protective field height H_{PFE} goes beyond the dimensions of the optics area to the outer borders of the circles labeled with R.

Electrical connection

Connection 1	
Type of connection	Connector
Function	Machine interface
Thread size	M12
Type	Male
Material	Metal
No. of pins	8 -pin
Encoding	A-coded
Connector housing	FE/SHIELD

Pin	Pin assignment	Conductor color
1	IO1	White
2	VIN1	Brown
3	IN3	Green
4	IN4	Yellow
5	OSSD1	Gray
6	OSSD2	Pink
7	VIN2	Blue
8	IN8	Red

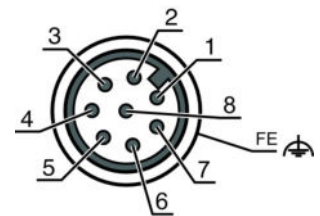

Circuit diagrams

Connection diagram receiver

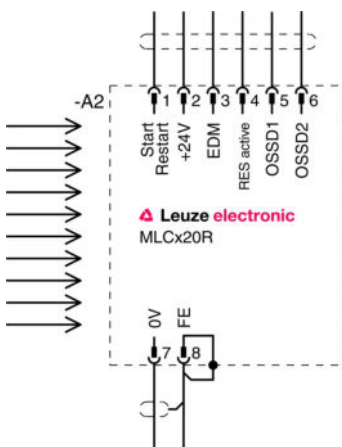

- VIN1 = +24 V, VIN2 = 0 V: transmission channel C1
- VIN1 = 0 V, VIN2 = +24 V: transmission channel C2

Circuit diagram example with downstream MSI-RM2 safety relay

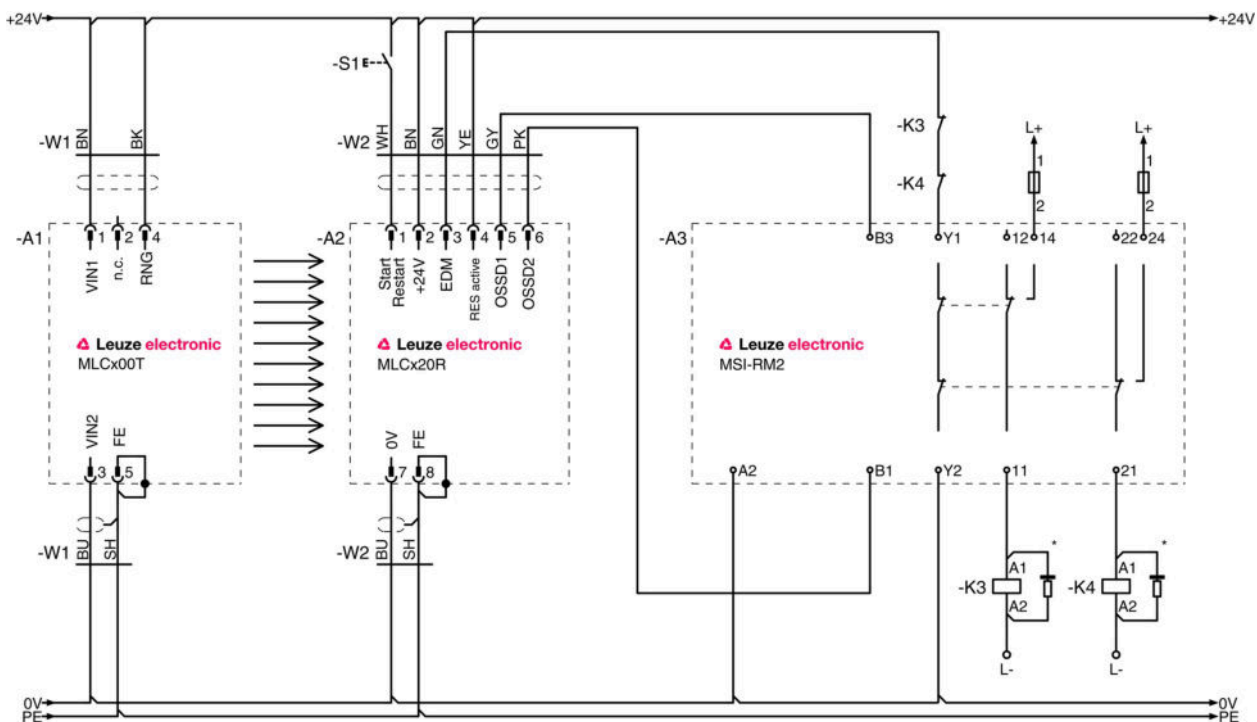

Operation and display

LEDs

LED	Display	Meaning
1	Off	Device switched off
	Red, continuous light	OSSD off
	Red, flashing, 1 Hz	External error
	Red, flashing, 10 Hz	Internal error
	Green, flashing, 1 Hz	OSSD on, weak signal
	Green, continuous light	OSSD on
2	Off	RES deactivated or RES activated and enabled or RES blocked and protective field interrupted
	Yellow, continuous light	RES activated and blocked but ready to be unlocked - protective field free and linked sensor is enabled if applicable

Suitable transmitters

	Part no.	Designation	Article	Description
	68000316	MLC500T30-1650	Safety light curtain transmitter	Resolution: 30 mm Protective field height: 1,650 mm Operating range: 0 ... 10 m Connection: Connector, M12, Metal, 5 -pin

Part no.: 68002316 – MLC520R30-1650 – Safety light curtain receiver

Part number code

Part designation: **MLCxyy-za-hhhhei-ooo**

MLC	Safety light curtain
x	Series: 3: MLC 300 5: MLC 500
yy	Function classes: 00: transmitter 01: transmitter (AIDA) 02: transmitter with test input 10: basic receiver - automatic restart 11: basic receiver - automatic restart (AIDA) 20: standard receiver - EDM/RES selectable 30: extended receiver - blanking/muting
z	Device type: T: transmitter R: receiver
a	Resolution: 14: 14 mm 20: 20 mm 30: 30 mm 40: 40 mm 90: 90 mm
hhhh	Protective field height: 150 ... 3000: from 150 mm to 3000 mm
e	Host/Guest (optional): H: Host MG: Middle Guest G: Guest
i	Interface (optional): /A: AS-i
ooo	Option: /V: high Vibration-proof EX2: explosion protection (zones 2 + 22) SPG: Smart Process Gating

Note

A list with all available device types can be found on the Leuze electronic website at www.leuze.com.

Notes

Observe intended use!

- The product may only be put into operation by competent persons.
- Only use the product in accordance with its intended use.

Accessories

Connection technology - Connection cables

	Part no.	Designation	Article	Description
	50135128	KD S-M12-8A-P1-050	Connection cable	Connection 1: Connector, M12, Axial, Female, A-coded, 8 -pin Connection 2: Open end Shielded: Yes Cable length: 5,000 mm Sheathing material: PUR

Part no.: 68002316 – MLC520R30-1650 – Safety light curtain receiver

Mounting technology - Swivel mounts

	Part no.	Designation	Article	Description
	429393	BT-2HF	Mounting bracket set	Contains: 2x BT-HF swivel mount, 1 cylinder for mounting on the light curtain Fastening, at system: Through-hole mounting Mounting bracket, at device: Clampable Type of mounting device: Turning, 360° Material: Metal, Plastic

Services

	Part no.	Designation	Article	Description
	S981050	CS40-I-140	Safety inspection "Safety light barriers"	Details: Checking of a safety light barrier application in accordance with current standards and guidelines. Inclusion of the device and machine data in a database, production of a test log per application. Conditions: It must be possible to stop the machine, support provided by customer's employees and access to the machine for Leuze employees must be ensured. Restrictions: Travel costs and accommodation expenses charged separately and according to expenditure.
	S981046	CS40-S-140	Start-up support	Details: For safety devices including stopping time measurement and initial inspection. Conditions: Devices and connection cables are already mounted, price not including travel costs and, if applicable, accommodation expenses. Restrictions: Max. 2 h., no mechanical (mounting) and electrical (wiring) work performed, no changes (attachments, wiring, programming) to third-party components in the nearby environment.

Note

A list with all available accessories can be found on the Leuze electronic website in the Download tab of the article detailed page.