









Ficha técnica

Rueda H-PGI 1-0024

Codigo				Tipo cojinete Eje					
1-0024	40	17	17	—	-	-	8	54	43



Características

Fabricada con chapa de acero hasta 2 mm de espesor.
Acabado cincado brillante.
Múltiples fijaciones: platina, agujero pasante, fijación para cantos, capuchón para mimbre.
Cojinete liso.

Datos técnicos

Diámetro: 40 mm
Carga: 17 kg
Tipo de cojinete: Cojinete Liso
Ancho de Banda de rodadura: 17 mm
Diámetro agujero pasante: 8 mm
Altura total: 54 mm
Radio de giro: 43 mm

Archivos CAD

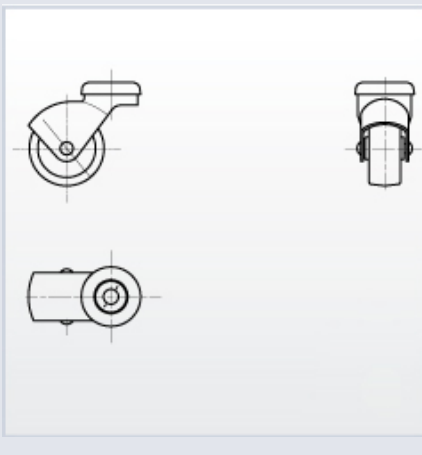
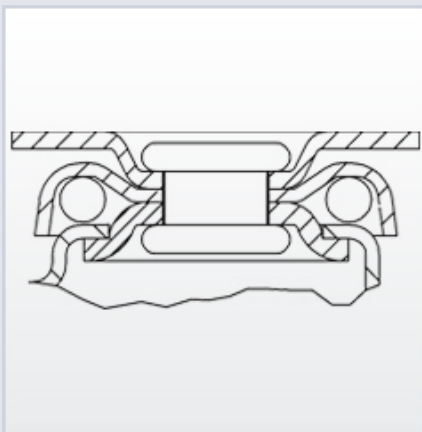

Rueda

PGI (Goma)
Núcleo de poliamix y banda de goma gris
Rango de temperatura: -20° ÷ +60°