

ITEM NUMBER	CIRCUIT SIZE
428B-0212	2
428B-0312	3
428B-0412	4
428B-0512	5
428B-0612	6

**LEGEND:**  
 428B - \*\* + 2  
 CIRCUIT SIZE  
 02-06  
 MOUNTING EAR OPTION  
 1 = WITH MOUNT. EARS  
 2 = W/O MOUNT. EARS  
 T.P.A. OPTION  
 2 = WITH T.P.A.

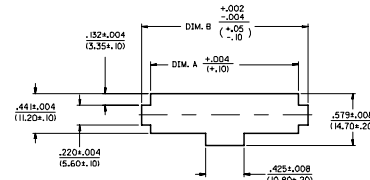

**RECOMMENDED PANEL CUT-OUT DETAIL**  
 (PANEL THICKNESS .071(1.80) MAX.)

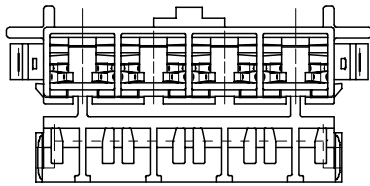
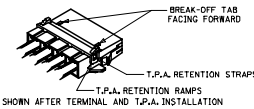
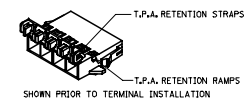
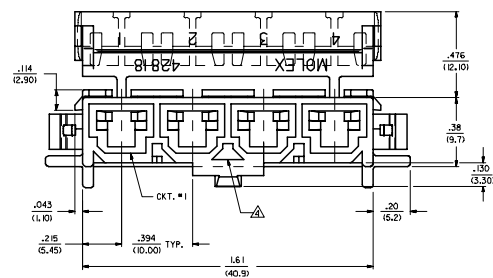
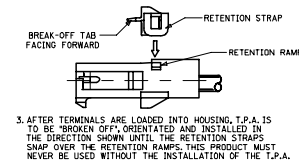
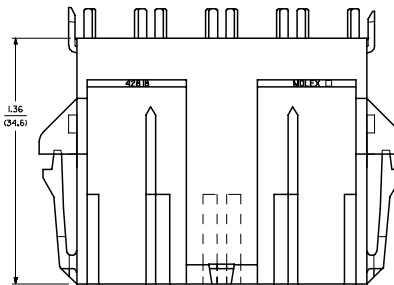
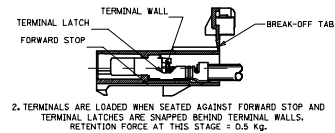
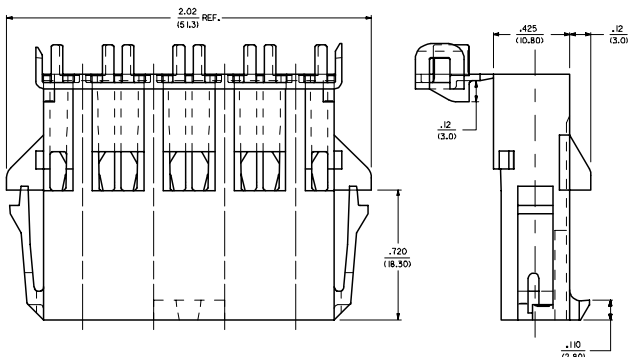
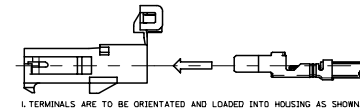

- NOTES:**
- MATERIALS  
 1 = POLYESTER, PBT, UL, 94V-0  
 COLOR: MOLDED BLACK
  - PART IS FOR USE WITH MALE CRIMP TERMINAL \*428IT.
  - PART IS DESIGNED IN METRIC.
  - NO CORE-OUT UNDER RAMP ON 3 AND 5 CIRCUIT PARTS.
  - PART MATES WITH MINI-FIT SR. RECEPTACLE 428B-\*\*\*12.
  - ITEM NUMBERS THAT ARE PRECEDED BY AN "X" IN THE CHART ARE NOT AVAILABLE.
  - DUE TO THE BREAKAWAY DESIGN OF THE T.P.A. COVER A FEW MAY HAVE PREMATUARELY SEPARATED FROM THEIR HOUSINGS DURING SHIPMENT, IF A HOUSING IS MISSING A T.P.A. COVER, IT CAN BE FOUND IN THE SHIPPING CONTAINER.
  - EACH WIRE MUST BE DRESSED SUCH THAT THE TERMINAL MAINTAINS ITS FREE FLOAT WITHIN THE HOUSING. SEE CHART FOR RECOMMENDED CABLE TIE PLACEMENT.
  - FOR PACKAGING INFORMATION SEE PK-428B-001

**\* THIS PRODUCT MUST NEVER BE USED WITHOUT THE T.P.A. \***

DIM. C	DIM. A	DIM. B	CIRCUIT SIZE
12.7	.854(21.70)	L083(27.50)	2
19.1	L248(31.70)	L476(37.50)	3
25.4	L642(41.70)	L870(47.50)	4
31.7	2.036(51.70)	2.264(57.50)	5
38.1	2.429(61.70)	2.651(67.50)	6

DRAWN BY: [Signature] CHECKED BY: [Signature] APPROVED BY: [Signature]	QUALITY SYMBOLS 	GENERAL TOLERANCES (UNLESS SPECIFIED) DIM. INCH ±.010 DIM. MM ±.25	DIMENSION STYLE IN/MM	SCALE 1:1	DESIGN UNITS METRIC	THRD ANGLE PROJECTION 	
	DESCRIPTION PLUG HOUSING, BUILT-IN TPA, 10MM CENTERS, MINIFIT SR. SERIES	DRAWN BY: JEP DATE: 1/13/96	CHECKED BY: [Signature] DATE: 1/13/96	APPROVED BY: [Signature] DATE: 1/13/96	MATERIAL NO. SD-42818-***2	DOCUMENT NO. SD-42818-***2	SHEET NO. 1 OF 1
	DRAFT WHERE APPLICABLE MUST REMAIN WITHIN DIMENSIONS	MOLEX INCORPORATED	THIS DRAWING CONTAINS INFORMATION THAT IS PROPRIETARY TO MOLEX INCORPORATED AND SHOULD NOT BE USED WITHOUT WRITTEN PERMISSION		MOLEX INCORPORATED	MOLEX INCORPORATED	MOLEX INCORPORATED
	MOLEX INCORPORATED	MOLEX INCORPORATED	MOLEX INCORPORATED	MOLEX INCORPORATED	MOLEX INCORPORATED	MOLEX INCORPORATED	MOLEX INCORPORATED