



Digital Modules AS-i in IP20, 22,5 mm

Cost efficient solution in IP20



(Figure similar)



Figure	Type	Housing	Primary application ⁽¹⁾	Inputs digital	Outputs digital	Input voltage (sensor supply) ⁽²⁾	Output voltage (actuator supply) ⁽³⁾	AS-i connection ⁽⁴⁾	AS-i address ⁽⁵⁾	Article No.
	IP20, 22,5 mm x 50 mm, 4 x COMBICON	4 x COMBICON	decentralized control cabinet	4	4 x electronic	out of AS-i	out of AS-i	clamps	1 AB slave	BWU2783
	IP20, 22,5 mm x 50 mm, 4 x COMBICON	4 x COMBICON	decentralized control cabinet	4	4 x electronic	out of AS-i	out of AS-i	clamps	1 single slave	BWU3272
	IP20, 22,5 mm x 114 mm, 4 x COMBICON	3 x COMBICON	control cabinet	4	–	out of AUX	–	clamps	1 AB slave	BWU2723
	IP20, 22,5 mm x 114 mm, 4 x COMBICON	4 x COMBICON	control cabinet	4	4 x electronic	out of AUX	out of AUX	clamps	1 AB slave	BWU1938
	IP20, 22,5 mm x 114 mm, 4 x COMBICON	4 x COMBICON	control cabinet	4	4 x electronic	out of AUX	out of AUX	clamps	1 single slave	BWU 2759
	IP20, 22,5 mm x 114 mm, 4 x COMBICON	4 x COMBICON	control cabinet	8	–	out of AUX	–	clamps	2 AB slaves	BWU2721
	IP20, 22,5 mm x 114 mm, 4 x COMBICON	4 x COMBICON	decentralized control cabinet	4	–	out of AS-i	–	clamps	1 AB slave	BWU3265
	IP20, 22,5 mm x 114 mm, 4 x COMBICON	4 x COMBICON	decentralized control cabinet	4	–	out of AUX	–	clamps	1 AB slave	BWU3266
	IP20, 22,5 mm x 114 mm, 6 x COMBICON	6 x COMBICON	control cabinet	4	4 x relay	out of AS-i	–	clamps	1 single slave	BWU3435
	IP20, 22,5 mm x 114 mm, 6 x COMBICON	6 x COMBICON	control cabinet	8	8 x electronic	out of AS-i	out of AUX	clamps	2 AB slaves	BWU3364
	IP20, 22,5 mm x 114 mm, 6 x COMBICON	6 x COMBICON	control cabinet	8	8 x electronic	out of AUX	out of AUX	clamps	2 AB slaves	BWU2490
	IP20, 22,5 mm x 114 mm, 6 x COMBICON	6 x COMBICON	control cabinet	8	8 x electronic	out of AUX	out of AUX	clamps	2 single slaves	BWU2800
	IP20, 22,5 mm x 114 mm, 6 x COMBICON	6 x COMBICON	control cabinet	8 (NPN)	8 x electronic (NPN)	out of AUX	out of AUX	clamps	2 AB slaves	BWU3359
	IP20, 22,5 mm x 114 mm, 6 x COMBICON	6 x COMBICON	decentralized control cabinet	4	4 x electronic	out of AS-i	out of AUX	clamps	1 AB slave	BWU3267
	IP20, 22,5 mm x 114 mm, 6 x COMBICON	6 x COMBICON	decentralized control cabinet	4	4 x electronic	out of AUX	out of AUX	clamps	1 AB slave	BWU3268

(1) **Primary Application**

Control cabinet: Cost-optimized modules whereby the supply voltage for the sensors and actuators is connected via additional patch terminals. Optimal application in the main control cabinet.

Decentralized control cabinet: Ideal for use in decentralized control cabinets. 3-wire sensors or actuators can be connected directly to terminals in the module without additional patch terminals or the module has an extremely flat design.

(2) **Input voltage (sensor supply):** inputs are supplied by AS-i or by AUX (auxiliary 24 V power). If supplied by AS-i, inputs shall not be connected to earth or to external potential.

(3) **Output voltage (actuator supply):** outputs are supplied by AS-i or by AUX (auxiliary 24 V power). If supplied by AS-i, outputs shall not be connected to earth or to external potential

(4) **AS-i connection:** the connection to AS-i as well to AUX (auxiliary 24 V power) is made via yellow resp. black AS-i profile cable with piercing technology or via M12 socket (in IP20 via clamps).

(5) **AS-i address:** 1 AB slave (max. 62 AB slaves/AS-i network), 2 AB slaves (max. 31 modules with 2 AB slaves), single slaves (max. 31 single slaves/AS-i network), mixed use allowed.

For modules with two slaves the second slave is turned off as long as the first slave is addressed to address "0".

Upon request, slaves are available with specific AS-i slave profiles.

Article no.	BWU3272		BWU2783	
General data				
Device type	input / output			
Connection				
AS-i / AUX connection	COMBICON plug			
Periphery connection	COMBICON plug			
Primary application	decentralized control cabinet			
Length of connector cable	I/O: max. 15 m ⁽¹⁾			
AS-i				
Profile	S-7.0.E, ID1=F (default)		S-7.A.7, ID1=7 (fixed)	
Address	1 single slave		1 AB slave	
Required Master profile	≥M0		≥M4	
Since AS-i specification	2.0		3.0	
Operating voltage	30 V (18 ... 31.6 V)			
Max. current consumption	165 mA			
Max. current consumption without sensor/ actuator supply	45 mA			
Input				
Number	4			
Power supply	out of AS-i			
Power supply of attached sensors	up to +40 °C	120 mA, ∑ (In/Out) 120 mA ⁽²⁾		
	at +55 °C	20 mA, ∑ (In/Out) 20 mA ⁽²⁾		
Switching threshold	U < 5 V (low) U > 15 V (high)			
Output				
Number	4 x electronic			
Power supply	out of AS-i			
Max. output current	up to +40 °C	120 mA per output, ∑ (In/Out) 120 mA ⁽²⁾		
	at +55 °C	20 mA, ∑ (In/Out) 20 mA ⁽²⁾		
Display				
LED ASI (green)	an: AS-i voltage on, flashing: AS-i voltage on, but peripheral fault ⁽³⁾ or address 0 off: no AS-i Voltage			
LED FLT/FAULT (red)	an: slave address 0 or slave offline flashing: peripheral fault ⁽³⁾ off: slave online			
LEDs I1 ... In (yellow)	state of inputs I1 ... I4			
LEDs O1 ... On (yellow)	state of outputs O1 ... O4			
Environment				
Applied standards	EN 61000-6-2 EN 61000-6-3 EN 60529			
Operating altitude	max. 2000 m			
Ambient temperature	-25 °C ... +40 °C (up to max. +55 °C) ⁽²⁾ no condensation permitted			
Storage temperature	-25 °C ... +85 °C			
Housing	plastic, for DIN rail mounting			
Protection category	IP20			
Voltage of insulation	≥500 V			
Weight	65 g			
Dimensions (W / H / D in mm)	22,5 / 99 / 50,5			

⁽¹⁾ Loop resistance ≤150 Ω

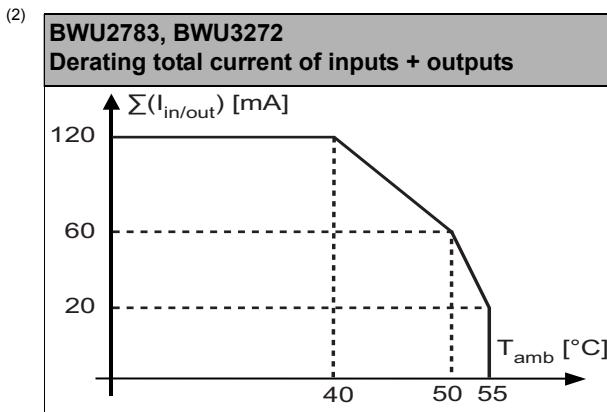

(3) see table „Peripheral fault indication“

Article no.	BWU3265		BWU3266	BWU3268	BWU3267
General data					
Device type	input			input / output	
Connection					
AS-i / AUX Connection	COMBICON plug				
Periphery connection	COMBICON plug				
Primary application	decentralized control cabinet				
Length of connector cable	I/O: unlimited ⁽¹⁾				
AS-i					
Profile	S-7.A.E, ID1=7 (default)			S-7.A.7, ID1=7 (fixed)	
Address	1 AB slave				
Required Master profile	≥M3			≥M4	
Since AS-i specification	2.1			3.0	
Operating voltage	30 V (18 ... 31.6 V)				
Max. current consumption	165 mA	35 mA		165 mA	
Max. current consumption without sensor/ actuator supply	45 mA	35 mA		45 mA	
AUX					
Voltage	-		24 V (18 ... 30 V)		
Max. current consumption	-		1,2 A	4,2 A	3 A
Input					
Number	4				
Power supply	out of AS-i		out of AUX		out of AS-i
power supply of attached sensors	up to +40 °C	120 mA ⁽²⁾	1200 mA permanent operation ⁽⁵⁾		120 mA ⁽²⁾
	at +55 °C	90 mA ⁽²⁾	900 mA permanent operation ⁽⁵⁾		90 mA ⁽²⁾
	at +70 °C	60 mA ⁽²⁾	600 mA permanent operation ⁽⁵⁾		60 mA ⁽²⁾
Switching threshold	U<5 V (low) U>15 V (high)				
Output					
Number	-		4 x electronic		
Power supply	-		out of AUX		
Max. output current	up to +50 °C	-		1 A per output, Σ (Out) 3,0 A ⁽⁶⁾	
	at +55 °C	-		1 A per output, Σ (Out) 2,5 A ⁽⁶⁾	
	at +70 °C	-		1 A per output, Σ (Out) 1,0 A ⁽⁶⁾	

Article no.	BWU3265	BWU3266	BWU3268	BWU3267
Display				
LED ASI (green)	an: AS-i voltage on, flashing: AS-i voltage on, but peripheral fault ⁽³⁾ or address 0 off: no AS-i Voltage			
LED FLT/FAULT (red)	an: slave address 0 or slave offline flashing: peripheral fault ⁽³⁾ off: slave online			
LEDs I1 ... I4 (yellow)	state of inputs I1 ... I4			
LEDs O1 ... O4 (yellow)	-		state of outputs O1 ... O4	
LED AUX (green)	-		on: 24 V _{DC} AUX off: no 24 V _{DC} AUX	
Environment				
Applied standards	EN 61000-6-2 EN 61000-6-3 EN 60529			
Operating altitude	max. 2000 m			
Ambient temperature	-25 °C ... +55 °C (up to max. +70 °C) ⁽²⁾ ⁽⁴⁾	-25 °C ... +55 °C (up to max. +70 °C) ⁽⁴⁾ ⁽⁵⁾ ⁽⁶⁾	-25 °C ... +55 °C (up to max. +70 °C) ⁽²⁾ ⁽⁴⁾	
	no condensation permitted			
Storage temperature	-25 °C ... +85 °C			
Housing	plastic, for DIN rail mounting			
Protection category	IP20			
Voltage of insulation	≥500 V			
Weight	120 g			
Dimensions (W / H / D in mm)	22,5 / 99 / 114			

(1) Loop resistance ≤150 Ω

(2)

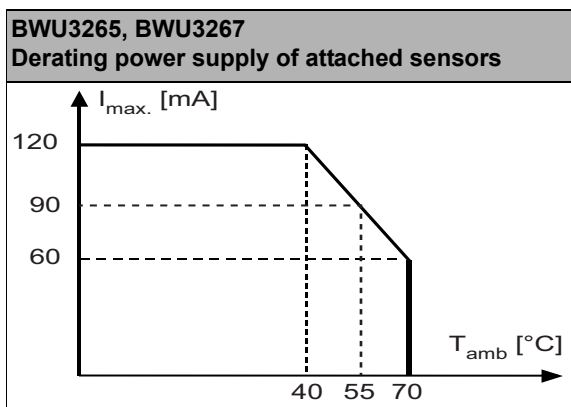

(3) see table „peripheral fault indication“

(4) Maximum ambient operating temperature +55 °C according UL certificate for the use in the USA and Canada.

(5)

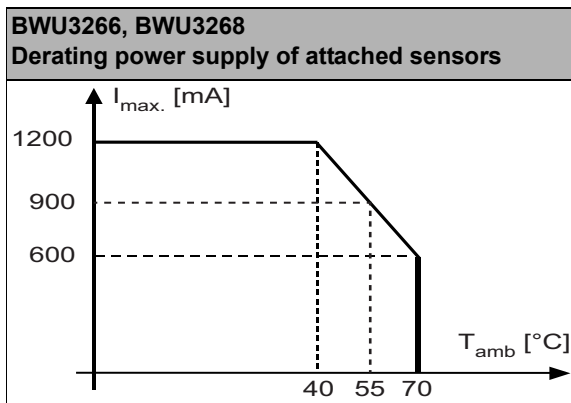

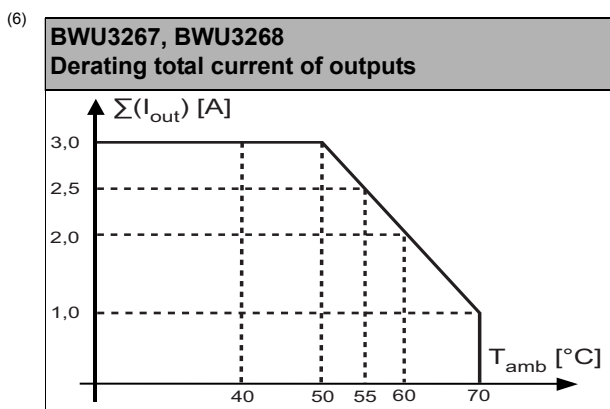

Article no.	BWU2723	BWU1938	BWU2759	BWU2721
General data				
Device type	input	inputs / output		input
Connection				
AS-i / AUX Connection				COMBICON plug
Periphery connection				COMBICON plug
Primary application				control cabinet
Length of connector cable				I/O: unlimited ⁽¹⁾
AS-i				
Profile	S-7.A.E, ID1=7 (default)	S-7.A.7, ID1=7 (fixed)	S-7.0.E, ID1=F (default)	slave 1: S-7.A.E, ID1=7 (default) slave 2: S-7.A.E, ID1=6 (default)
Address	1 AB slave		1 single slave	2 AB slaves
Required Master profile	≥M3	≥M4	≥M0	≥M3
Since AS-i specification	2.1	3.0	2.0	2.1
Operating voltage	30 V (18 ... 31.6 V)			
Max. current consumption	35 mA			60 mA
Max. current consumption without sensor/ actuator supply	35 mA			60 mA
AUX				
Voltage	24 V (18 ... 30 V)			
Max. current consumption	1,2 A	4 A		1,2 A
Input				
Number	4			8
Power supply	out of AUX			
power supply of attached sensors	up to +40 °C	1200 mA permanent operation ⁽²⁾		
	at +55 °C	900 mA permanent operation ⁽²⁾		
	at +70 °C	600 mA permanent operation ⁽²⁾		
Switching threshold	U<5 V (low) U>15 V (high)			
Output				
Number	–	4 x electronic		–
Power supply	–	out of AUX		–
Max. output current	up to +50 °C	–	1 A per output, Σ (Out) 3,0 A ⁽⁵⁾	
	at +55 °C	–	1 A per output, Σ (Out) 2,5 A ⁽⁵⁾	
	at +70 °C	–	1 A per output, Σ (Out) 1,0 A ⁽⁵⁾	

Article no.	BWU2723	BWU1938	BWU2759	BWU2721
Display				
LED ASI (green)	an: AS-i voltage on, flashing: AS-i voltage on, but peripheral fault ⁽³⁾ or address 0 off: no AS-i Voltage			–
LED FLT/FAULT (red)	an: slave address 0 or slave offline flashing: peripheral fault ⁽³⁾ off: slave online			–
LED ASI/FLT 1 (red/green)	–			green: slave online red: slave offline yellow/red flashing: address 0 red/green flashing: peripheral fault ⁽³⁾
LED ASI/FLT 2 (red/green)	–			green: slave online red: slave offline yellow/red flashing: address 0 red/green flashing: peripheral fault ⁽³⁾ red flashing: slave 2 is switched off, because slave 1 is offline
LEDs I1 ... I4 (yellow)	state of inputs I1 ... I4			state of inputs I1 ... I8
LEDs O1 ... O4 (yellow)	–	state of outputs O1 ... O4		–
LED AUX (green)	on: 24 V _{DC} AUX off: no 24 V _{DC} AUX			
Environment				
Applied standards	EN 61000-6-2 EN 61000-6-3 EN 60529			
Operating altitude	max. 2000 m			
Ambient temperature	-25 °C ... +55 °C (up to max. +70 °C) ⁽²⁾ ⁽⁴⁾	-25 °C ... +55 °C (up to max. +70 °C) ⁽²⁾ ⁽⁴⁾ ⁽⁵⁾	-25 °C ... +55 °C (up to max. +70 °C) ⁽²⁾ ⁽⁴⁾	
	no condensation permitted			
Storage temperature	-25 °C ... +85 °C			
Housing	plastic, for DIN rail mounting			
Protection category	IP20			
Voltage of insulation	≥500 V			
Weight	120 g			
Dimensions (W / H / D in mm)	22,5 / 99 / 114			

(1) Loop resistance ≤150 Ω

(2) **BWU1938, BWU2721, BWU2723, BWU2759**
Derating power supply of attached sensors

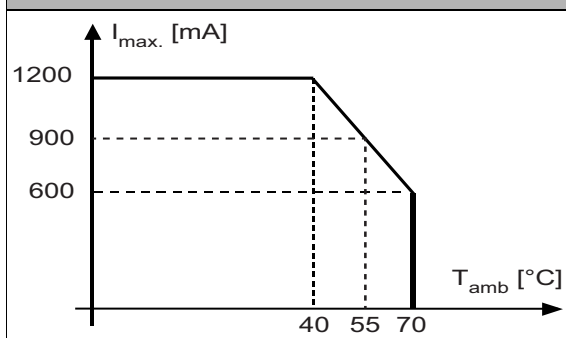

(3) see table „peripheral fault indication“

(4) Maximum ambient operating temperature +55 °C according UL certificate for the use in the USA and Canada.

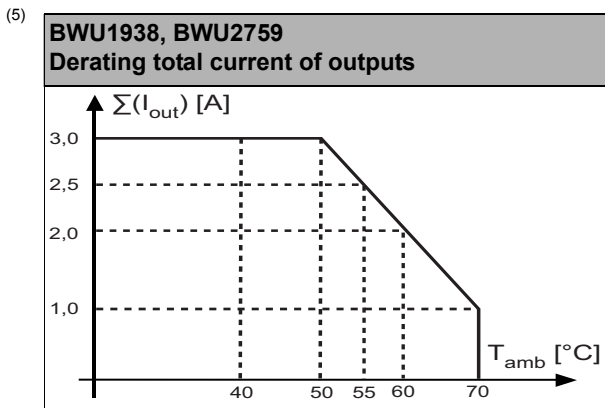

Article no.	BWU3364	BWU2490	BWU2800	BWU3359
General data				
Device type	input / output			
Connection				
AS-i / AUX connection	COMBICON plug			
Periphery connection	COMBICON plug			
Primary application	control cabinet			
Length of connector cable	I/O: unlimited ⁽¹⁾			
AS-i				
Profile	slave 1: S-7.A.7, ID1=7 (fixed), slave 2: S-7.A.7, ID1=6 (default)	slave 1: S-7.0.E, ID1=F (default), slave 2: S-7.0.E, ID1=E (default)	slave 1: S-7.A.7, ID1=7 (fixed), slave 2: S-7.A.7, ID1=6 (default)	
Address	2 AB slaves	2 single slaves	2 AB slaves	
Required Master profile	≥M4	≥M0	≥M4	
Since AS-i specification	3.0	2.0	3.0	
Operating voltage	30 V (18 ... 31.6 V)			
Max. current consumption	320 mA	60 mA		
Max. current consumption without sensor/ actuator supply	60 mA	60 mA		
AUX				
Voltage	24 V (18 ... 30 V)			
Max. current consumption	8 A			
Input				
Number	8			8 (NPN)
Power supply	out of AS-i	out of AUX		
Power supply of attached sensors	up to +40 °C	260 mA ⁽²⁾	900 mA permanent operation ⁽⁵⁾	1200 mA permanent operation ⁽⁹⁾
	at +55 °C	130 mA ⁽²⁾	700 mA permanent operation ⁽⁵⁾	900 mA permanent operation ⁽⁹⁾
	at +70 °C	–	600 mA permanent operation ⁽⁵⁾	600 mA permanent operation ⁽⁹⁾
Switching threshold	U<5 V (low) U>15 V (high)			ground I+ -U<5 V (low) -U>15 V (high)

Article no.		BWU3364	BWU2490	BWU2800	BWU3359
Output					
Number		8 x electronic			8 x electronic (NPN)
Power supply		out of AUX			
Max. output current	up to +40 °C	1 A per output, $\sum (O1 \dots O4) 3 A +$ $\sum (O5 \dots O8) 3 A^{(3)}$	1 A per output, $\sum (O1 \dots O4) 3 A +$ $\sum (O5 \dots O8) 3 A^{(6)}$		0,5 A per output, $\sum (Out) 4 A^{(10)}$
	at +55 °C	1 A per output, $\sum (O1 \dots O4) 2 A +$ $\sum (O5 \dots O8) 2 A^{(3)}$			
	at +70 °C	–	1 A per output, $\sum (O1 \dots O8) 1 A^{(6)}$		0,5 A per output, $\sum (Out) 0,5 A^{(10)}$
Display					
LED ASI/FLT 1 (red/green)		green: slave online red: slave offline yellow/red flashing: address 0			
LED ASI/FLT 2 (red/green)		green: slave online red: slave offline yellow/red flashing: address 0 red/green flashing: peripheral fault ⁽⁴⁾ red flashing: slave 2 is switched off, because slave 1 is offline			
LEDs I1 ... In (yellow)		state of inputs I1 ... I8			
LEDs O1 ... On (yellow)		state of outputs O1 ... O8			
LED AUX (green)		on: 24 V _{DC} AUX off: no 24 V _{DC} AUX			
Environment					
Applied standards		EN 61000-6-2 EN 61000-6-3 EN 60529			
Operating altitude		max. 2000 m			
Ambient temperature		30 °C ... +55 °C ^{(2) (3)}	-30 °C ... +55 °C (up to max. +70 °C) ^{(5) (6) (7) (8)}		-30 °C ... +55 °C (up to max. +70 °C) ^{(7) (9) (10)}
		no condensation permitted			
Storage temperature		-25 °C ... +85 °C			
Housing		plastic, for DIN rail mounting			
Protection category		IP20			
Voltage of insulation		≥500 V			
Weight		120 g			
Dimensions (W / H / D in mm)		22,5 / 99 / 114			

(1) Loop resistance ≤150 Ω

(2)

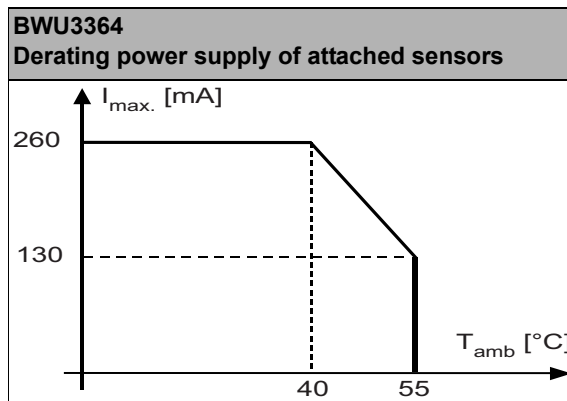

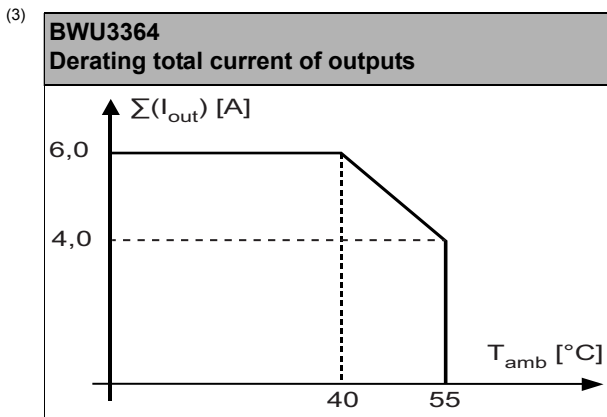

(4) see table „peripheral fault indication“

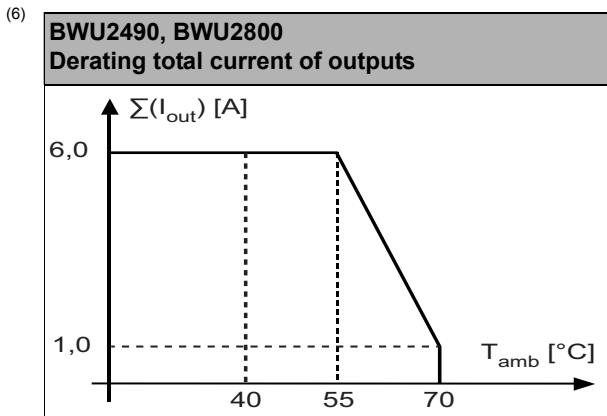
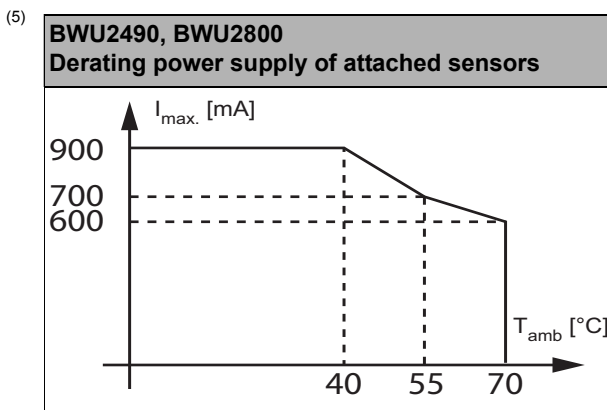

(7) Maximum ambient operating temperature +55 °C according UL certificate for the use in the USA and Canada.

(8) Temperature range up to -30°C from Ident.No. ≥16283 (BWU2490); Ident.No. ≥16299 (BWU2800).

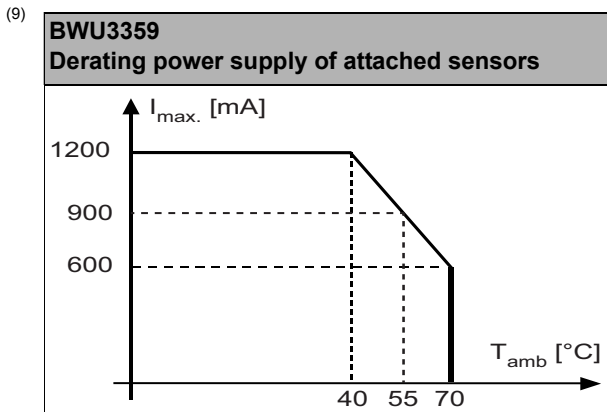

(10)

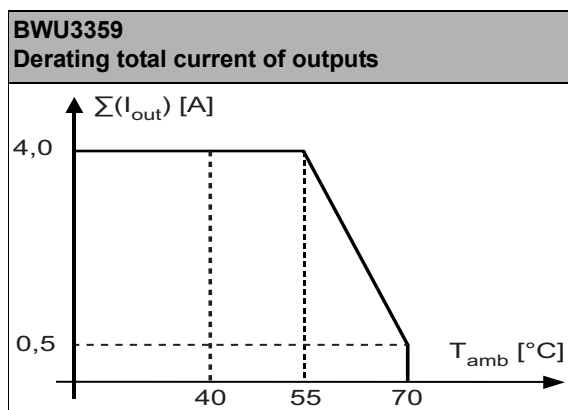

Article no.		BWU3435
General data		
Device type	input / output	
Connection		
AS-i / AUX Connection	COMBICON plug	
Periphery connection	COMBICON plug	
Primary application	control cabinet	
Length of connector cable	I/O: unlimited ⁽¹⁾	
AS-i		
Profile	S-7.F.E, ID1=F (default)	
Address	1 single slave	
Required Master profile	≥M0	
Since AS-i specification	2.0	
Operating voltage	30 V (26,5 ... 31.6 V)	
Max. current consumption	200 mA	
Max. current consumption without sensor/ actuator supply	45 mA	
AUX		
Voltage	-	
Max. current consumption	-	
Input		
Number	4	
Power supply	out of AS-i	
Power supply of attached sensors	up to +40 °C	120 mA ⁽²⁾
	at +55 °C	90 mA ⁽²⁾
	at +70 °C	60 mA ⁽²⁾
Switching threshold	U < 5 V (low) U > 15 V (high)	
Output		
Number	4 x relay outputs, normally open, 230 VAC/2A/AC-14, 30 VDC/2A/DC-13 Σ (Out) 8 A	
Relay control	out of AS-i	
Max. output current	-	
Display		
LED ASI (green)	an: AS-i voltage on, flashing: AS-i voltage on, but peripheral fault ⁽³⁾ or address 0 off: no AS-i Voltage	
LED FLT/FAULT (red)	an: slave address 0 or slave offline flashing: peripheral fault ⁽³⁾ off: slave online	
LEDs I1 ... In (yellow)	state of inputs I1 ... I4	
LEDs O1 ... On (yellow)	state of outputs O1 ... O4	

Article no.	BWU3435
Environment	
Applied standards	EN 61000-6-2 EN 61000-6-3 EN 60529
Operating altitude	max. 2000 m
Ambient temperature	-25 °C ... +55 °C (up to max. +70 °C) ⁽²⁾ ⁽⁴⁾ no condensation permitted
Storage temperature	-25 °C ... +85 °C
Housing	plastic, for DIN rail mounting
Protection category	IP20
Voltage of insulation	≥500 V
Weight	120 g
Dimensions (W / H / D in mm)	22,5 / 99 / 114

(1) Loop resistance ≤150 Ω

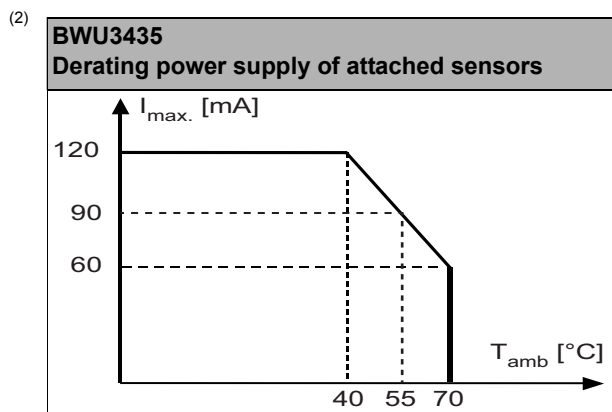

(3) see table "Peripheral fault indication"

(4) Maximum ambient operating temperature +55 °C according UL certificate for the use in the USA and Canada.

Article no.	Peripheral fault indication	
	Overload sensor supply	AUX voltage missing
BWU1938	•	•
BWU2490	-	•
BWU2721	-	•
BWU2723	-	•
BWU2759	•	•
BWU2783	•	-
BWU2800	-	•
BWU3265	•	-
BWU3266	•	•
BWU3267	•	•
BWU3268	•	•
BWU3272	•	-
BWU3359	-	•
BWU3364	•	•
BWU3435	•	-

Programming	Bit setting			
	D0	D1	D2	D3
	Input			
BWU1938 / BWU2723 / BWU2759 / BWU2783 / BWU3265 / BWU3266 / BWU3267 / BWU3268 / BWU3272 / BWU3435	I1	I2	I3	I4
BWU2490 / BWU2721 / BWU2800 / BWU3359 / BWU3364	slave 1: I1	slave 1: I2	slave 1: I3	slave 1: I4
	slave 2: I5	slave 2: I6	slave 2: I7	slave 2: I8
	output			
BWU1938 / BWU2759 / BWU2783 / BWU3267 / BWU3268 / BWU3272 / BWU3435	O1	O2	O3	O4
BWU2490 / BWU2800 / BWU3359 / BWU3364	slave 1: O1	slave 1: O2	slave 1: O3	slave 1: O4
	slave 2: O5	slave 2: O6	slave 2: O7	slave 2: O8

Programming	Bit setting			
	parameter bit			
	P0	P1	P2	P3
BWU3364 / BWU2723 / BWU2721 / BWU3265 / BWU3266	0 = off / 1 = on (peripheral fault, if AUX voltage missing)	0 = on / 1 = off (data input filter 128 µs)	0 = on / 1 = off (synchronous I/O mode)	not used
BWU1938 / BWU2759 / BWU2783 / BWU3267 / BWU3268 / BWU3272 / BWU3435	0 = off / 1 = on (watchdog)			
BWU2490 / BWU2800 / BWU3359	not used, watchdog always on			

Connections

Name	Explanation
I _x	digital input x
O _x	digital output x
O _{x3} , O _{x4}	relay output x
I ₊ , I ₋ , I ₊ _n , I ₋ _n	sensor supply
O ₋ _n	GND for outputs (PNP)
O ₊ _n	GND for outputs (NPN)
AUX ⁺ _{ext.in}	power supply, out of external voltage, positive pole (AUX, actuator supply)
AUX ⁻ _{ext.in}	power supply, out of external voltage, negative pole (AUX, actuator supply)
AS-i+, AS-i-	connection to AS-i bus
ADDR	connection for AS-i addressing device
n.c. (not connected)	not connected

Connections		
<p>BWU3265</p> <p>Inputs: I1, I2, I3, I4 Outputs: O1, O2, O3, O4</p> <p>Labels: FAULT, ASI, ADDR, ASI+</p>	<p>BWU3266</p> <p>Inputs: I1, I2, I3, I4 Outputs: O1, O2, O3, O4</p> <p>Labels: FAULT, ASI, ADDR, AUX, ASI+, AUX+</p>	<p>BWU2723</p> <p>Inputs: I1, I2, I3, I4 Outputs: O1, O2, O3, O4</p> <p>Labels: FAULT, PWR, ADDR, AUX, ASI+, AUX+</p>
<p>BWU2783 / BWU3272</p> <p>Inputs: I1, I2, I3, I4 Outputs: O1, O2, O3, O4</p> <p>Labels: FAULT, ASI, ADDR, ASI+, ASI-</p>	<p>BWU1938 / BWU2759</p> <p>Inputs: I1, I2, I3, I4 Outputs: O1, O2, O3, O4</p> <p>Labels: FAULT, ASI, ADDR, AUX, ASI+, AUX+</p>	<p>BWU2721</p> <p>Inputs: I1, I2, I3, I4 Outputs: O1, O2, O3, O4</p> <p>Labels: FAULT, ASI/FLT2, ASI/FLT1, ADDR1, ADDR2, ASI+, AUX+</p>
<p>BWU3267 / BWU3268</p> <p>Inputs: I1, I2, I3, I4 Outputs: O1, O2, O3, O4</p> <p>Labels: FAULT, ASI, ADDR, ASI+, ASI-</p>	<p>BWU2490 / BWU2800 / BWU3364</p> <p>Inputs: I1, I2, I3, I4 Outputs: O1, O2, O3, O4</p> <p>Labels: FAULT, ASI/FLT2, ASI/FLT1, ADDR1, ADDR2, ASI+, AUX+</p>	<p>BWU3359</p> <p>Inputs: I1, I2, I3, I4 Outputs: O1, O2, O3, O4</p> <p>Labels: FAULT, ASI/FLT2, ASI/FLT1, ADDR1, ADDR2, ASI+, AUX+</p>

Connections

BWU3435

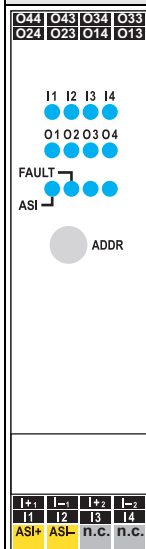

Power supply PNP

Input module

BWU1938 / BWU2490 / BWU2721 / BWU2723 /
 BWU2759 / BWU2783 / BWU2800 / BWU3265 /
 BWU3266 / BWU3267 / BWU3268 / BWU3272 /
 BWU3364

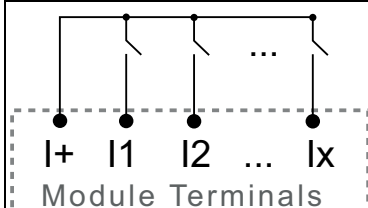

Output module

BWU1938 / BWU2490 / BWU2759 / BWU2783 /
 BWU2800 / BWU3267 / BWU3268 / BWU3272 /
 BWU3364

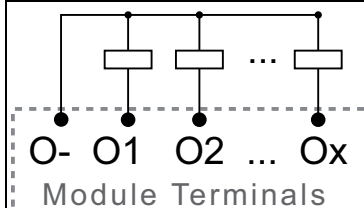

Separate power supply

BWU1938 / BWU2490 / BWU2759 / BWU2800

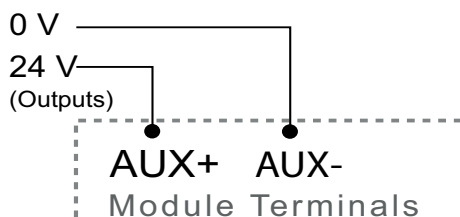
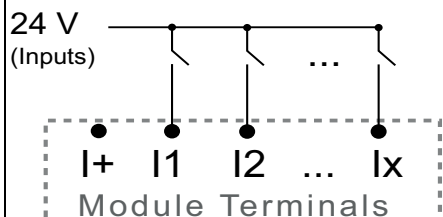

Power supply NPN

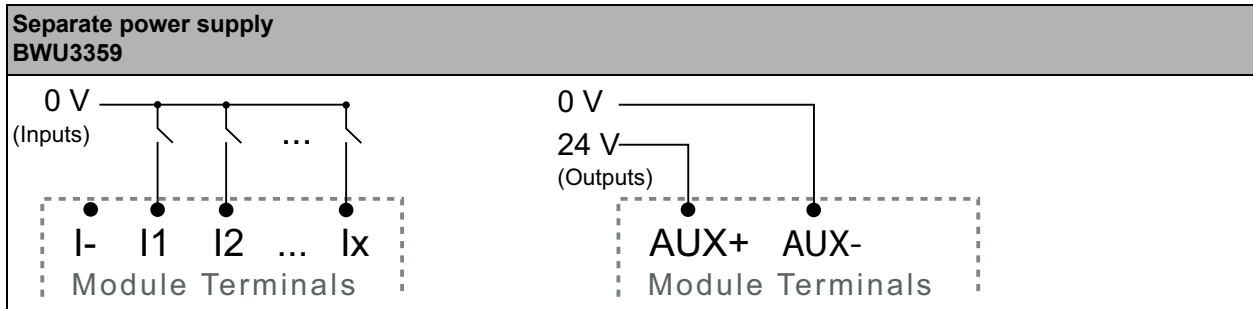
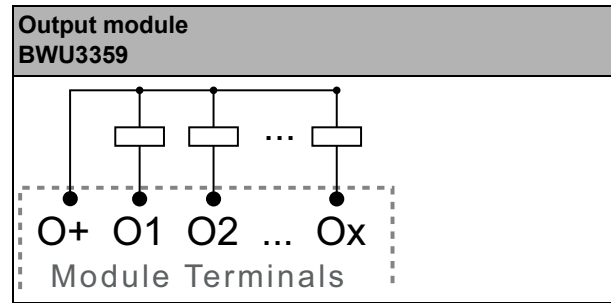
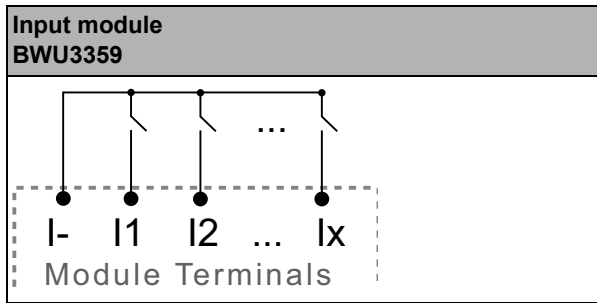

Connection relay output

