

ACCES.F.FUSE SWI. DISCONNECTOR FOR NH3  
SADDLE TERMINAL



Figure similar

Model	
product brand name	SENTRON
Design of the product	for 3NP1 fuse switch disconnectors, saddle terminal 150 to 300 mm <sup>2</sup> , for size NH3 with flat connector

Accessories	
accessories	Connection system

General Product Approval	Declaration of Conformity
--------------------------	---------------------------



### Further information

**Information- and Downloadcenter (Catalogs, Brochures,...)**

<http://www.siemens.com/lowvoltage/catalogs>

**Industry Mall (Online ordering system)**

<https://eb.automation.siemens.com/mall/en/WW/Catalog/Product/3NP19631BA00>

**Service&Support (Manuals, Certificates, Characteristics, FAQs,...)**

<http://support.automation.siemens.com/WW/view/en/3NP19631BA00/all>

**Image database (product images, 2D dimension drawings, 3D models, device circuit diagrams, ...)**

[http://www.automation.siemens.com/bilddb/cax\\_en.aspx?mlfb=3NP19631BA00](http://www.automation.siemens.com/bilddb/cax_en.aspx?mlfb=3NP19631BA00)

**CAX-Online-Generator**

<http://www.siemens.com/cax>

**Tender specifications**

<http://ausschreibungstexte.siemens.com/tiplv>

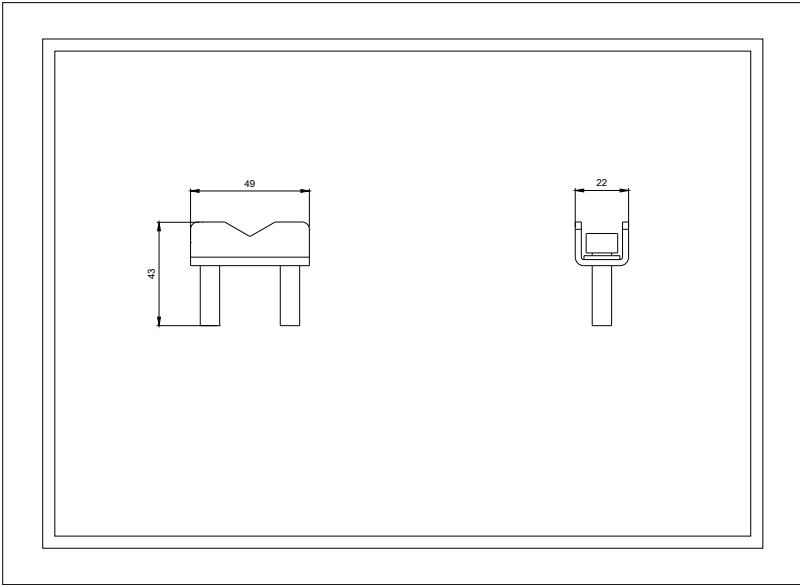

last modified:

11.03.2015