

SIRIUS POSITION SWITCH; PLASTIC HOUSING ACC. TO EN50047, 50MM DEVICE CONNECTION 2X(M20X1.5); 1NO/2NC SLOW-ACTION CONTACTS LEDS 110-230V AC, YELLOW/GREEN TEFLON PLUNGER

Product designation		standard position switch
<b>Manufacturer article number</b>		
<ul style="list-style-type: none"> <li>• of the supplied basic switch</li> <li>• of the supplied switching contacts</li> <li>• of the supplied empty enclosure with cover</li> </ul>		<a href="#">3SE5242-3KC05</a> <a href="#">3SE5000-0LA00</a> <a href="#">3SE5242-0AC05</a>

General technical data:

<b>Product function</b>		
<ul style="list-style-type: none"> <li>• positive opening</li> </ul>		Yes
<b>Insulation voltage</b>		
<ul style="list-style-type: none"> <li>• Rated value</li> </ul>	V	400
<b>Degree of pollution</b>		class 3
<b>Shock resistance</b>		30g / 11 ms
<b>Vibration resistance</b>		0.35 mm / 5g
<b>Surge voltage resistance Rated value</b>	kV	4
<b>Mechanical service life (switching cycles)</b>		
<ul style="list-style-type: none"> <li>• typical</li> </ul>		15 000 000
<b>Electrical endurance (switching cycles)</b>		
<ul style="list-style-type: none"> <li>• at AC-15 at 230 V typical</li> </ul>		100 000
<b>Electrical endurance (switching cycles) with contactor 3RH11, 3RT1016, 3RT1017, 3RT1024, 3RT1025, 3RT1026 typical</b>		10 000 000
<b>Electrical operating cycles in one hour with contactor 3RH11, 3RT1016, 3RT1017, 3RT1024, 3RT1025, 3RT1026</b>		6 000
<b>Thermal current</b>	A	6
<b>Material of the enclosure of the switch head</b>		plastic

<b>Protection class IP</b>		IP66/IP67
<b>Equipment marking</b>		
<ul style="list-style-type: none"> <li>• acc. to DIN EN 61346-2</li> <li>• acc. to DIN EN 81346-2</li> </ul>		B B
<b>Active principle</b>		mechanical
<b>Repeat accuracy</b>	mm	0.05
Explosion protection category for dust		none
Explosion protection category for gas		none
Minimum actuating force in activation direction	N	20
<b>Operating current at AC-15</b>		
<ul style="list-style-type: none"> <li>• at 230 V Rated value</li> </ul>	A	1.5
<b>Operating current</b>		
<ul style="list-style-type: none"> <li>• at DC-13 at 125 V Rated value</li> </ul>	A	0.55
<b>Operating current</b>		
<ul style="list-style-type: none"> <li>• at DC-13</li> <li>— at 24 V Rated value</li> </ul>	A	3

<b>Enclosure:</b>		
<b>Design of the housing</b>		block, wide
<b>Material of the enclosure</b>		plastic
<b>Coating of the enclosure</b>		Other types
<b>Design of the housing acc. to standard</b>		No

<b>Drive Head:</b>		
<b>Design of the operating mechanism</b>		teflon plunger
<b>Standard-compliant actuator head</b>		EN 50047, design B
<b>Shape of the switch head</b>		rounded
<b>Design of the switching function</b>		positive opening

<b>Connections/ Terminals:</b>		
<b>Type of electrical connection</b>		screw-type terminals
<b>Type of connectable conductor cross-section</b>		
<ul style="list-style-type: none"> <li>• solid</li> <li>• finely stranded with core end processing</li> <li>• finely stranded without core end processing</li> <li>• for AWG conductors</li> </ul>		1x (0.5 ... 1.5 mm <sup>2</sup> ), 2x (0.5 ... 0.75 mm <sup>2</sup> )
		1x (0.5 ... 1.5 mm <sup>2</sup> ), 2x (0.5 ... 0.75 mm <sup>2</sup> )
		1x (0.5 ... 1.5 mm <sup>2</sup> ), 2x (0.5 ... 0.75 mm <sup>2</sup> )
— solid		1x (20 ... 16), 2x (20 ... 18)
— stranded		1x (20 ... 16), 2x (20 ... 18)

<b>Mechanical data:</b>		
<b>Cable entry type</b>		2 x (M20 x 1.5)

<b>Communication/ Protocol:</b>		
<b>Design of the interface</b>		without

<b>Ambient conditions:</b>		
----------------------------	--	--

<b>Ambient temperature</b>		
• during operation	°C	-25 ... +60
• during storage	°C	-40 ... +90





#### Supply voltage:

<b>Type of voltage of the supply voltage</b>		
• of the optional LED indicator		AC
<b>Supply voltage</b>		
• of LED	V	230

#### Installation/ mounting/ dimensions:

<b>mounting position</b>		any
<b>Mounting type</b>		screw fixing

#### Certificates/ approvals:

General Product Approval	Declaration of Conformity	Test Certificates	other
 CSA	 UL	 EAC	 EG-Konf.
		<a href="#">Special Test Certificate</a>	<a href="#">Confirmation</a>

#### Further information

**Information- and Downloadcenter (Catalogs, Brochures,...)**

<http://www.siemens.com/industrial-controls/catalogs>

**Industry Mall (Online ordering system)**

<http://www.siemens.com/industrymall>

**Cax online generator**

<http://support.automation.siemens.com/WW/CAXorder/default.aspx?lang=en&mfb=3SE52423KC05>

**Service&Support (Manuals, Certificates, Characteristics, FAQs,...)**

<http://support.automation.siemens.com/WW/view/en/3SE52423KC05/all>

**Image database (product images, 2D dimension drawings, 3D models, device circuit diagrams, EPLAN macros, ...)**

[http://www.automation.siemens.com/bilddb/cax\\_de.aspx?mfb=3SE52423KC05&lang=en](http://www.automation.siemens.com/bilddb/cax_de.aspx?mfb=3SE52423KC05&lang=en)

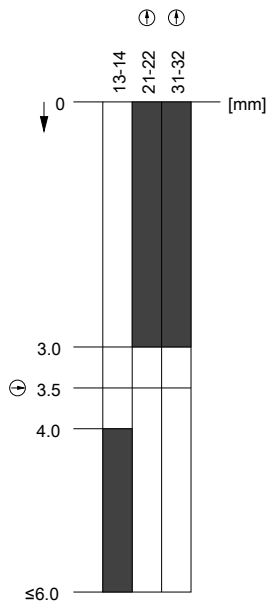
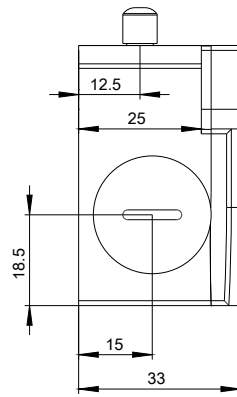
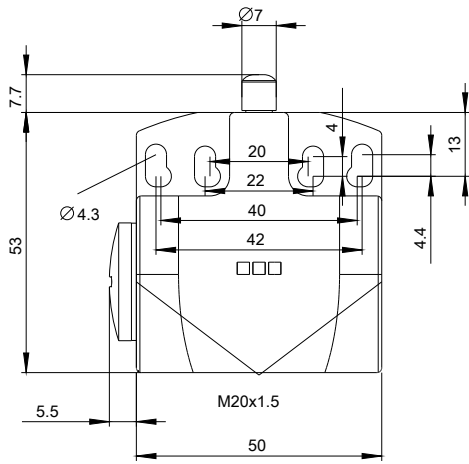

last modified:

09.03.2015