

Contactor AC3: 55kW / 400 V 3-pole Size S6 Coil AC 50/60Hz and DC 200...277 V x (0,8...1,1) auxiliary contacts: 2 NO + 2 NC Main: Box terminal coil and auxiliary: screw and aux. circuit: screw terminal



Figure similar

|   |                 |
|---|-----------------|
| Product brand name                                  | SIRIUS          |
| Product designation                                 | Power contactor |
| Product type designation                            | 3RT1            |
| <b>General technical data</b>                       |                 |
| Size of contactor                                   | S6              |
| Product extension                                   |                 |
| • function module for communication                 | No              |
| • Auxiliary switch                                  | Yes             |
| Insulation voltage                                  |                 |
| • rated value                                       | 1 000 V         |
| Degree of pollution                                 | 3               |
| Surge voltage resistance rated value                | 8 kV            |
| maximum permissible voltage for safe isolation      |                 |
| • between coil and main contacts acc. to EN 60947-1 | 690 V           |
| Protection class IP                                 |                 |
| • on the front                                      | IP00            |

|   |                            |
|---|----------------------------|
| • of the terminal   | IP00                       |
| <b>Shock resistance at rectangular impulse</b>                                      |                            |
| • at AC   | 8,5g / 5 ms, 4,2g / 10 ms  |
| • at DC   | 8,5g / 5 ms, 4,2g / 10 ms  |
| <b>Shock resistance with sine pulse</b>   |                            |
| • at AC   | 13,4g / 5 ms, 6,5g / 10 ms |
| • at DC   | 13,4g / 5 ms, 6,5g / 10 ms |
| <b>Mechanical service life (switching cycles)</b>                                   |                            |
| • of contactor typical  | 10 000 000                 |
| • of the contactor with added electronics-compatible auxiliary switch block typical | 5 000 000                  |
| • of the contactor with added auxiliary switch block typical                        | 10 000 000                 |

### Ambient conditions

|  |                |
|--|----------------|
| <b>Installation altitude at height above sea level</b> |                |
| • maximum  | 2 000 m        |
| <b>Ambient temperature</b>                             |                |
| • during operation                                     | -25 ... +60 °C |
| • during storage                                       | -55 ... +80 °C |

### Main circuit

|   |         |
|---|---------|
| <b>Number of poles for main current circuit</b>         | 3       |
| <b>Number of NO contacts for main contacts</b>          | 3       |
| <b>Operating voltage</b>                                |         |
| • at AC-3 rated value maximum                           | 1 000 V |
| <b>Operating current</b>                                |         |
| • at AC-1 at 400 V                                      |         |
| — at ambient temperature 40 °C rated value              | 160 A   |
| • at AC-1   |         |
| — up to 690 V at ambient temperature 40 °C rated value  | 160 A   |
| — up to 690 V at ambient temperature 60 °C rated value  | 140 A   |
| — up to 1000 V at ambient temperature 40 °C rated value | 80 A    |
| — up to 1000 V at ambient temperature 60 °C rated value | 80 A    |
| • at AC-2 at 400 V rated value                          | 115 A   |
| • at AC-3   |         |
| — at 400 V rated value                                  | 115 A   |
| — at 500 V rated value                                  | 115 A   |
| — at 690 V rated value                                  | 115 A   |
| — at 1000 V rated value                                 | 53 A    |

|  |   |
|--|---|
| <b>Connectable conductor cross-section in main circuit at AC-1</b>   |   |
| <ul style="list-style-type: none"> <li>• at 60 °C minimum permissible</li> <li>• at 40 °C minimum permissible</li> </ul>   | <p>50 mm<sup>2</sup></p> <p>70 mm<sup>2</sup></p>   |
| <b>Operating current for approx. 200000 operating cycles at AC-4</b>   |   |
| <ul style="list-style-type: none"> <li>• at 400 V rated value</li> <li>• at 690 V rated value</li> </ul>   | <p>54 A</p> <p>48 A</p>   |
| <b>Operating current</b>   |   |
| <ul style="list-style-type: none"> <li>• at 1 current path at DC-1 <ul style="list-style-type: none"> <li>— at 24 V rated value</li> <li>— at 110 V rated value</li> <li>— at 220 V rated value</li> <li>— at 440 V rated value</li> <li>— at 600 V rated value</li> </ul> </li> <li>• with 2 current paths in series at DC-1 <ul style="list-style-type: none"> <li>— at 24 V rated value</li> <li>— at 110 V rated value</li> <li>— at 220 V rated value</li> <li>— at 440 V rated value</li> <li>— at 600 V rated value</li> </ul> </li> <li>• with 3 current paths in series at DC-1 <ul style="list-style-type: none"> <li>— at 24 V rated value</li> <li>— at 110 V rated value</li> <li>— at 220 V rated value</li> <li>— at 440 V rated value</li> <li>— at 600 V rated value</li> </ul> </li> </ul> | <p>160 A</p> <p>18 A</p> <p>3.4 A</p> <p>0.8 A</p> <p>0.5 A</p> <p>160 A</p> <p>160 A</p> <p>20 A</p> <p>3.2 A</p> <p>1.6 A</p> <p>160 A</p> <p>160 A</p> <p>160 A</p> <p>11.5 A</p> <p>4 A</p> |
| <b>Operating current</b>   |   |
| <ul style="list-style-type: none"> <li>• at 1 current path at DC-3 at DC-5 <ul style="list-style-type: none"> <li>— at 24 V rated value</li> <li>— at 110 V rated value</li> <li>— at 220 V rated value</li> <li>— at 440 V rated value</li> <li>— at 600 V rated value</li> </ul> </li> <li>• with 2 current paths in series at DC-3 at DC-5 <ul style="list-style-type: none"> <li>— at 24 V rated value</li> <li>— at 110 V rated value</li> <li>— at 220 V rated value</li> <li>— at 440 V rated value</li> <li>— at 600 V rated value</li> </ul> </li> <li>• with 3 current paths in series at DC-3 at DC-5 <ul style="list-style-type: none"> <li>— at 24 V rated value</li> </ul> </li> </ul>   | <p>160 A</p> <p>2.5 A</p> <p>0.6 A</p> <p>0.17 A</p> <p>0.12 A</p> <p>160 A</p> <p>160 A</p> <p>2.5 A</p> <p>0.65 A</p> <p>0.37 A</p> <p>160 A</p>  |

|   |               |
|---|---------------|
| — at 110 V rated value  | 160 A         |
| — at 220 V rated value  | 160 A         |
| — at 440 V rated value  | 1.4 A         |
| — at 600 V rated value  | 0.75 A        |
| <b>Operating power</b>  |               |
| • at AC-1   |               |
| — at 230 V at 60 °C rated value   | 53 kW         |
| — at 400 V rated value  | 92 kW         |
| — at 400 V at 60 °C rated value   | 92 kW         |
| — at 690 V rated value  | 160 kW        |
| — at 690 V at 60 °C rated value   | 159 kW        |
| — at 1000 V at 60 °C rated value  | 131 kW        |
| • at AC-2 at 400 V rated value  | 55 kW         |
| • at AC-3   |               |
| — at 230 V rated value  | 37 kW         |
| — at 400 V rated value  | 55 kW         |
| — at 500 V rated value  | 75 kW         |
| — at 690 V rated value  | 110 kW        |
| — at 1000 V rated value   | 75 kW         |
| <b>Operating power for approx. 200000 operating cycles at AC-4</b>                            |               |
| • at 400 V rated value  | 29 kW         |
| • at 690 V rated value  | 48 kW         |
| <b>Thermal short-time current limited to 10 s</b>   | 1 100 A       |
| <b>Power loss [W] at AC-3 at 400 V for rated value of the operating current per conductor</b> | 7 W           |
| <b>No-load switching frequency</b>  |               |
| • at DC   | 1 000 1/h     |
| <b>Operating frequency</b>  |               |
| • at AC-1 maximum   | 800 1/h       |
| • at AC-2 maximum   | 400 1/h       |
| • at AC-3 maximum   | 1 000 1/h     |
| • at AC-4 maximum   | 130 1/h       |
| <b>Control circuit/ Control</b>   |               |
| <b>Type of voltage of the control supply voltage</b>  | AC/DC         |
| <b>Control supply voltage at AC</b>   |               |
| • at 50 Hz rated value  | 200 ... 277 V |
| • at 60 Hz rated value  | 200 ... 277 V |
| <b>Control supply voltage at DC</b>   |               |
| • rated value   | 200 ... 277 V |
| <b>Operating range factor control supply voltage rated value of magnet coil at DC</b>         |               |

|   |                                |
|---|--------------------------------|
| <ul style="list-style-type: none"> <li>• initial value</li> </ul>                     | 0.8                            |
| <ul style="list-style-type: none"> <li>• Full-scale value</li> </ul>                  | 1.1                            |
| <b>Operating range factor control supply voltage rated value of magnet coil at AC</b> |                                |
| <ul style="list-style-type: none"> <li>• at 50 Hz</li> </ul>                          | 0.8 ... 1.1                    |
| <ul style="list-style-type: none"> <li>• at 60 Hz</li> </ul>                          | 0.8 ... 1.1                    |
| <b>Design of the surge suppressor</b>   | with varistor                  |
| <b>Apparent pick-up power of magnet coil at AC</b>                                    |                                |
| <ul style="list-style-type: none"> <li>• at 50 Hz</li> </ul>                          | 280 V·A                        |
| <b>Inductive power factor with closing power of the coil</b>                          |                                |
| <ul style="list-style-type: none"> <li>• at 50 Hz</li> </ul>                          | 0.8                            |
| <b>Apparent holding power of magnet coil at AC</b>                                    |                                |
| <ul style="list-style-type: none"> <li>• at 50 Hz</li> </ul>                          | 4.4 V·A                        |
| <b>Inductive power factor with the holding power of the coil</b>                      |                                |
| <ul style="list-style-type: none"> <li>• at 50 Hz</li> </ul>                          | 0.5                            |
| <b>Closing power of magnet coil at DC</b>   | 320 W                          |
| <b>Holding power of magnet coil at DC</b>   | 2.8 W                          |
| <b>Closing delay</b>  |                                |
| <ul style="list-style-type: none"> <li>• at AC</li> </ul>                             | 60 ... 75 ms                   |
| <ul style="list-style-type: none"> <li>• at DC</li> </ul>                             | 60 ... 75 ms                   |
| <b>Opening delay</b>  |                                |
| <ul style="list-style-type: none"> <li>• at AC</li> </ul>                             | 115 ... 130 ms                 |
| <ul style="list-style-type: none"> <li>• at DC</li> </ul>                             | 115 ... 130 ms                 |
| <b>Recovery time after power failure typical</b>                                      | 2 s                            |
| <b>Arcing time</b>  | 10 ... 15 ms                   |
| <b>Control version of the switch operating mechanism</b>                              | Fail-safe PLC input (F-PLC-IN) |

#### Auxiliary circuit

|   |      |
|---|------|
| <b>Number of NC contacts</b>  |      |
| <ul style="list-style-type: none"> <li>• for auxiliary contacts <ul style="list-style-type: none"> <li>— instantaneous contact</li> </ul> </li> </ul> | 2    |
| <b>Number of NO contacts</b>  |      |
| <ul style="list-style-type: none"> <li>• for auxiliary contacts <ul style="list-style-type: none"> <li>— instantaneous contact</li> </ul> </li> </ul> | 2    |
| <b>Operating current at AC-12 maximum</b>   | 10 A |
| <b>Operating current at AC-15</b>   |      |
| <ul style="list-style-type: none"> <li>• at 230 V rated value</li> </ul>  | 6 A  |
| <ul style="list-style-type: none"> <li>• at 400 V rated value</li> </ul>  | 3 A  |
| <ul style="list-style-type: none"> <li>• at 500 V rated value</li> </ul>  | 2 A  |
| <ul style="list-style-type: none"> <li>• at 690 V rated value</li> </ul>  | 1 A  |
| <b>Operating current at DC-12</b>   |      |
| <ul style="list-style-type: none"> <li>• at 24 V rated value</li> </ul>   | 10 A |

|   |   |
|---|---|
| <ul style="list-style-type: none"> <li>• at 48 V rated value</li> <li>• at 60 V rated value</li> <li>• at 110 V rated value</li> <li>• at 125 V rated value</li> <li>• at 220 V rated value</li> <li>• at 600 V rated value</li> </ul>  | <p>6 A</p> <p>6 A</p> <p>3 A</p> <p>2 A</p> <p>1 A</p> <p>0.15 A</p>                |
| <b>Operating current at DC-13</b> <ul style="list-style-type: none"> <li>• at 24 V rated value</li> <li>• at 48 V rated value</li> <li>• at 60 V rated value</li> <li>• at 110 V rated value</li> <li>• at 125 V rated value</li> <li>• at 220 V rated value</li> <li>• at 600 V rated value</li> </ul> | <p>10 A</p> <p>2 A</p> <p>2 A</p> <p>1 A</p> <p>0.9 A</p> <p>0.3 A</p> <p>0.1 A</p> |
| <b>Contact reliability of auxiliary contacts</b>  | <p>1 faulty switching per 100 million (17 V, 1 mA)</p>                              |

#### UL/CSA ratings

|  |  |
|--|--|
| <b>Full-load current (FLA) for three-phase AC motor</b> <ul style="list-style-type: none"> <li>• at 480 V rated value</li> <li>• at 600 V rated value</li> </ul>   | <p>124 A</p> <p>125 A</p>  |
| <b>Yielded mechanical performance [hp]</b> <ul style="list-style-type: none"> <li>• for single-phase AC motor <ul style="list-style-type: none"> <li>— at 230 V rated value</li> </ul> </li> <li>• for three-phase AC motor <ul style="list-style-type: none"> <li>— at 200/208 V rated value</li> <li>— at 220/230 V rated value</li> <li>— at 460/480 V rated value</li> <li>— at 575/600 V rated value</li> </ul> </li> </ul> | <p>25 hp</p> <p>40 hp</p> <p>50 hp</p> <p>100 hp</p> <p>125 hp</p> |
| <b>Contact rating of auxiliary contacts according to UL</b>  | <p>A600 / P600</p>   |

#### Short-circuit protection

|  |  |
|--|--|
| <b>Design of the fuse link</b> <ul style="list-style-type: none"> <li>• for short-circuit protection of the main circuit <ul style="list-style-type: none"> <li>— with type of coordination 1 required</li> <li>— with type of assignment 2 required</li> </ul> </li> <li>• for short-circuit protection of the auxiliary switch required</li> </ul> | <p>Fuse gG: 355 A</p> <p>Fuse gG: 315 A</p> <p>fuse gG: 10 A</p> |
|--|--|

#### Installation/ mounting/ dimensions

|  |   |
|--|---|
| <b>Mounting position</b>   | <p>+/-180° rotation possible on vertical mounting surface; can be tilted forward and backward by +/- 22.5° on vertical mounting surface</p> |
| <b>Mounting type</b> <ul style="list-style-type: none"> <li>• Side-by-side mounting</li> </ul> | <p>screw fixing</p> <p>Yes</p>  |

|        |        |
|--------|--------|
| Height | 172 mm |
| Width  | 120 mm |
| Depth  | 170 mm |





### Connections/Terminals

|   |  |
|---|--|
| <b>Type of electrical connection</b> <ul style="list-style-type: none"> <li>• for main current circuit</li> <li>• for auxiliary and control current circuit</li> </ul>  | screw-type terminals<br>screw-type terminals   |
| <b>Type of connectable conductor cross-sections</b> <ul style="list-style-type: none"> <li>• for main contacts <ul style="list-style-type: none"> <li>— stranded</li> <li>— finely stranded with core end processing</li> <li>— finely stranded without core end processing</li> </ul> </li> <li>• at AWG conductors for main contacts</li> </ul> | max. 2x 70 mm <sup>2</sup><br>max. 1x 50, 1x 70 mm <sup>2</sup><br>max. 1x 50, 1x 70 mm <sup>2</sup><br><br>2x 1/0   |
| <b>Type of connectable conductor cross-sections</b> <ul style="list-style-type: none"> <li>• for auxiliary contacts <ul style="list-style-type: none"> <li>— solid</li> <li>— single or multi-stranded</li> <li>— finely stranded with core end processing</li> </ul> </li> <li>• at AWG conductors for auxiliary contacts</li> </ul>             | 2x (0.5 ... 1.5 mm <sup>2</sup> ), 2x (0.75 ... 2.5 mm <sup>2</sup> ), max. 2x (0.75 ... 4 mm <sup>2</sup> )<br>2x (0,5 ... 1,5 mm <sup>2</sup> ), 2x (0,75 ... 2,5 mm <sup>2</sup> ), max. 2x (0,75 ... 4 mm <sup>2</sup> )<br>2x (0.5 ... 1.5 mm <sup>2</sup> ), 2x (0.75 ... 2.5 mm <sup>2</sup> )<br><br>2x (20 ... 16), 2x (18 ... 14), 1x 12 |

### Safety related data

|   |                |
|---|----------------|
| <b>Safety device type acc. to IEC 61508-2</b>   | Type B         |
| <b>B10 value</b> <ul style="list-style-type: none"> <li>• with high demand rate acc. to SN 31920</li> </ul>   | 1 000 000      |
| <b>Safety Integrity Level (SIL) acc. to IEC 61508</b>   | 2              |
| <b>SIL Claim Limit (subsystem) acc. to EN 62061</b>   | 2              |
| <b>Performance level (PL) acc. to EN ISO 13849-1</b>  | c              |
| <b>Category acc. to EN ISO 13849-1</b>  | 2              |
| <b>Stop category acc. to DIN EN 60204-1</b>   | 0              |
| <b>Proportion of dangerous failures</b> <ul style="list-style-type: none"> <li>• with low demand rate acc. to SN 31920</li> <li>• with high demand rate acc. to SN 31920</li> </ul> | 40 %<br>73 %   |
| <b>Product function</b> <ul style="list-style-type: none"> <li>• Mirror contact acc. to IEC 60947-4-1</li> <li>• positively driven operation acc. to IEC 60947-5-1</li> </ul>       | Yes<br>No      |
| <b>PFHD with high demand rate acc. to EN 62061</b>  | 0.00000045 1/h |
| <b>PFDAvg with low demand rate acc. to IEC 61508</b>  | 0.007          |
| <b>MTBF</b>   | 75 y           |
| <b>Hardware fault tolerance acc. to IEC 61508</b>   | 0              |
| <b>T1 value for proof test interval or service life acc. to IEC 61508</b>   | 20 y           |

## Certificates/approvals

| General Product Approval   | Functional Safety/Safety of Machinery  | Declaration of Conformity   | Test Certificates   |
|--|--|---|---|
| <br>CCC | <br>CSA |  | <br>EG-Konf. |
|  |  | <a href="#">Type Examination Certificate</a>                                      | <a href="#">Special Test Certificate</a>  |

| Marine / Shipping   | other                         |
|---|-------------------------------|
| <br>DNV-GL<br>DNVGL.COM/AF | <a href="#">Confirmation</a>  |
|   | <a href="#">Miscellaneous</a> |

## Further information

**Information- and Downloadcenter (Catalogs, Brochures,...)**

<http://www.siemens.com/industrial-controls/catalogs>

**Industry Mall (Online ordering system)**

<https://mall.industry.siemens.com/mall/en/en/Catalog/product?mlfb=3RT1054-1SP36>

**Cax online generator**

<http://support.automation.siemens.com/WW/CAXorder/default.aspx?lang=en&mlfb=3RT1054-1SP36>

**Service&Support (Manuals, Certificates, Characteristics, FAQs,...)**

<https://support.industry.siemens.com/cs/ww/en/ps/3RT1054-1SP36>

**Image database (product images, 2D dimension drawings, 3D models, device circuit diagrams, EPLAN macros, ...)**

[http://www.automation.siemens.com/bilddb/cax\\_de.aspx?mlfb=3RT1054-1SP36&lang=en](http://www.automation.siemens.com/bilddb/cax_de.aspx?mlfb=3RT1054-1SP36&lang=en)



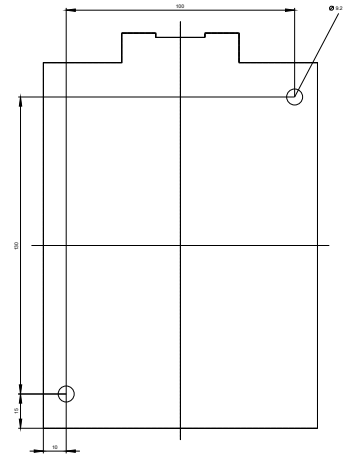
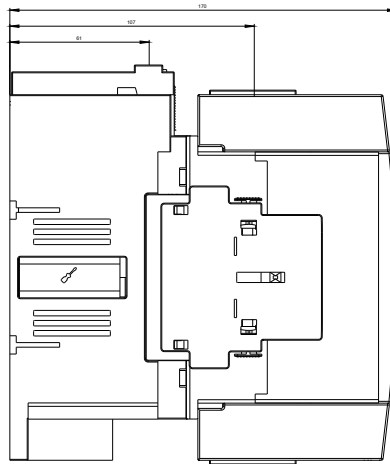
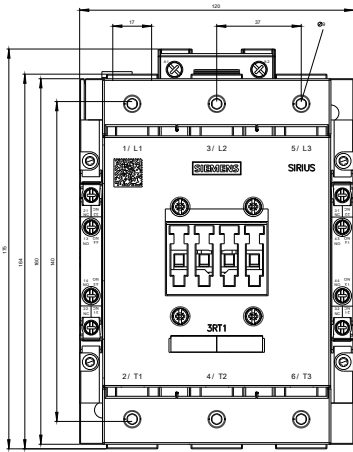

last modified:

10/13/2017